







## IZPĀRDOŠANA

	<p>1</p>	<p>335740575</p>	<p>158.73 <del>239.74</del></p>	<p>0803060</p>	<p><i>Virtuves izlietnes jaucējkrāns</i></p>
	<p>2</p>	<p>88011</p>	<p>71.14 <del>113.20</del></p>	<p>0805017</p>	<p><i>Iebūvējamā daļa</i></p>
	<p>1</p>	<p>38826N</p>	<p>63.30 <del>86.58</del></p>	<p>0802041</p>	<p><i>Mehānisms zemapmetuva jaucējkrānam</i></p>
	<p>1</p>	<p>3610005</p>	<p>169.70 <del>434.48</del></p>	<p>0808005</p>	<p><i>Izlietnes krāns ar sensoru</i></p>
	<p>1</p>	<p>3660005</p>	<p>155.00 <del>276.03</del></p>	<p>0808002</p>	<p><i>Pisuāra krāns ar sensoru</i></p>

## KRĀNI AR SENSORU

**VEIKALS  
EUR**

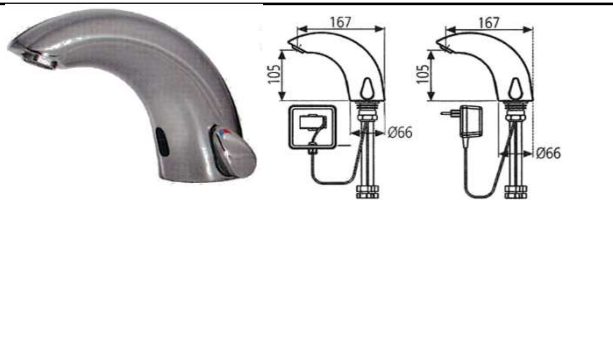
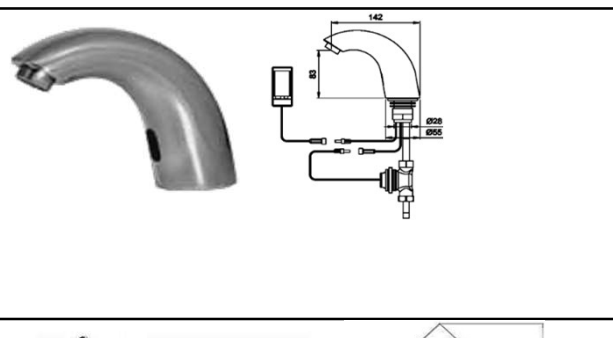
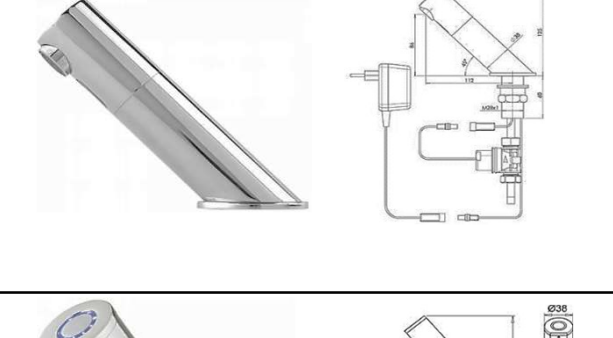
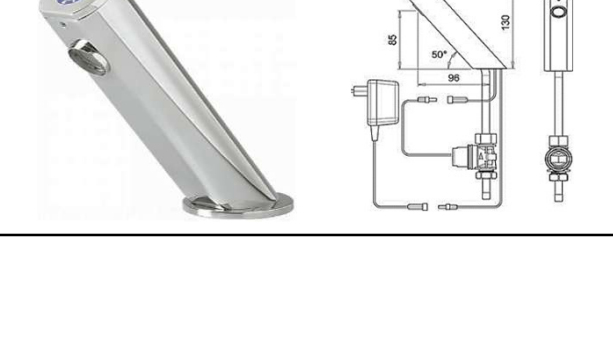
	<p><i>Izlietnes krāns ar grozāmu izteku</i> (9V baterija montējama pie sienas)</p> <p>DOLPHIN LB 1040 T    270160    <b>174.85</b>    <b>1508001</b></p> <p style="text-align: center;"><b>3</b></p>
	<p><i>Izlietnes jaucējkrāns</i> (9V baterija krāna korpusā)</p> <p>SWAN 1000 B    252300    <b>179.99</b>    <b>1508003</b> (ar 9V transformatoru slēdzams pie 220V tīkla)</p> <p style="text-align: center;"><b>1</b></p>
	<p><i>Izlietnes krāns sagatavotam ūdenim</i> (9V baterija montējama pie sienas)</p> <p>EASY B    246010    <b>146.05</b>    <b>1508011</b></p> <p style="text-align: center;"><b>4</b></p>
	<p><i>Izlietnes krāns vienam ūdenim</i></p> <p>TUBULAR    350700    <b>146.05</b>    <b>1508020</b></p> <p style="text-align: center;"><b>1</b></p>
	<p><i>Izlietnes krāns vienam ūdenim</i></p> <p>TOUCH    225500    <b>120.34</b>    <b>1508021</b></p> <p style="text-align: center;"><b>1</b></p>



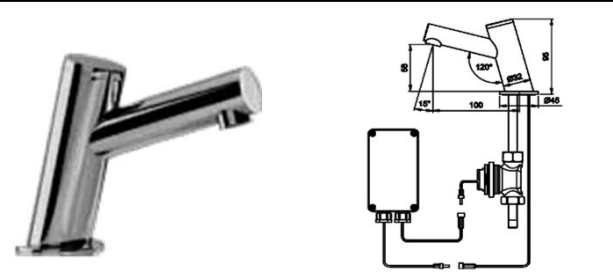
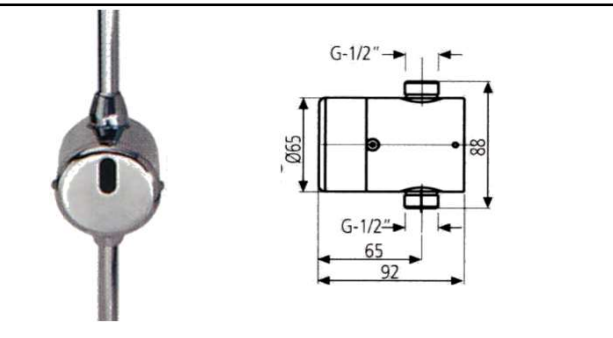
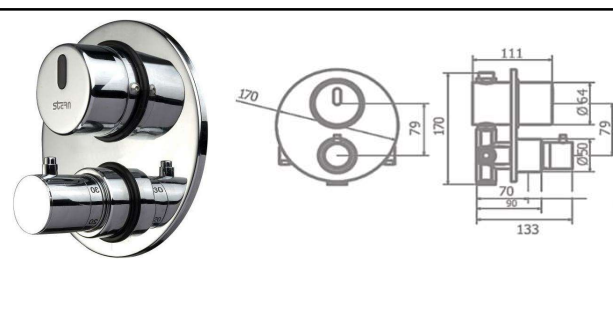
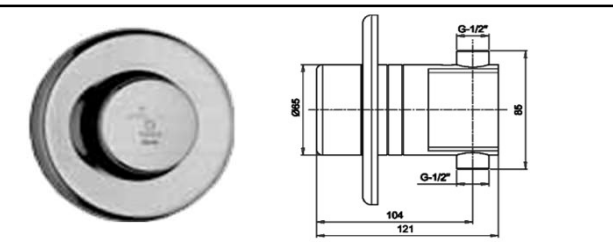
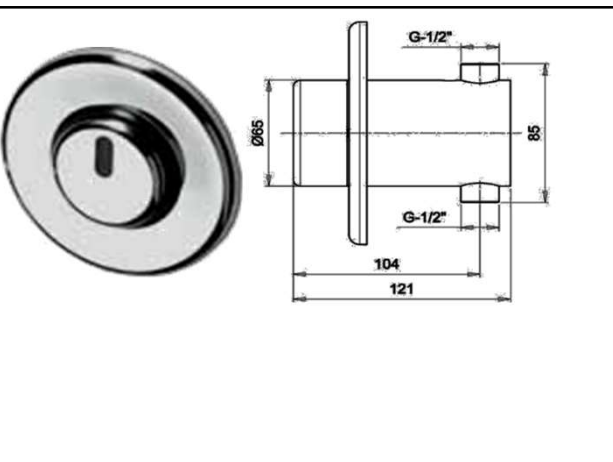
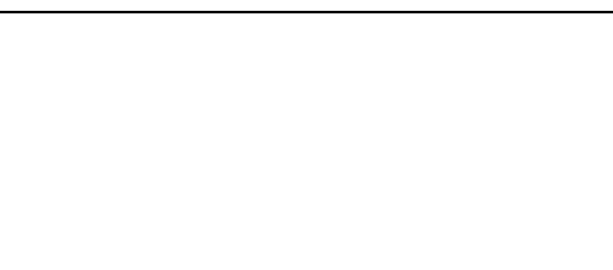

# KRĀNI AR SENSORU

**VEIKALS  
EUR**



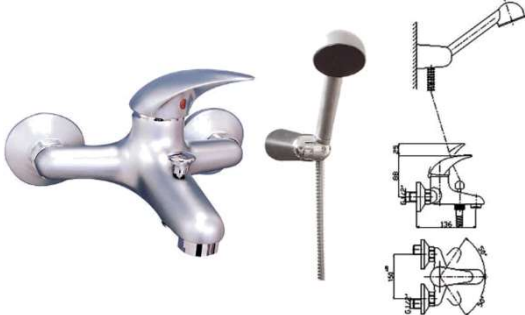
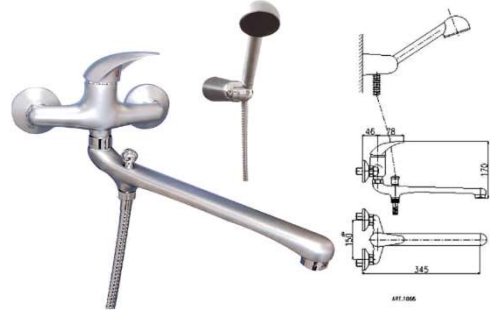



	<p><i>Izlietnes krāns sajauktam ūdenim ar dozātoru</i></p> <p>PERFECT TIME B 220100 <b>87.42</b> 1508014 (9V baterija montējama pie sienas)</p> <p><b>6</b></p>
	<p><i>Caurplūdes krāns dušai, sajauktam ūdenim</i> (9V baterija krāna korpusā)</p> <p>NEPTUNE 1011 B 610261 <b>113.14</b> 1508005</p> <p><b>9</b></p>
	<p><i>Iebūvējams dušas krāns ar termostatu</i> (9V baterija krāna korpusā)</p> <p>NEPTUNE 1041 T 612241 <b>262.27</b> 1508019</p> <p><b>1</b></p>
	<p><i>Iebūvējams dušas krāns ar dozātoru</i> (9V baterija krāna korpusā)</p> <p>PERFECT TIME SH 1031 613700 <b>133.71</b> 1508017</p> <p><b>2</b></p>
	<p><i>Iebūvējams dušas krāns</i> (9V baterija krāna korpusā)</p> <p>NEPTUNE 1031 613200 <b>149.14</b> 1508013</p> <p><b>3</b></p>
	<p><i>Pisuāra krāns</i> (9V baterija krāna korpusā)</p> <p>JUPITER 1031 134510 <b>159.42</b> 1508012</p> <p><b>3</b></p>

## JAUCĒJKRĀNI AR SVIRAS ROKTURI

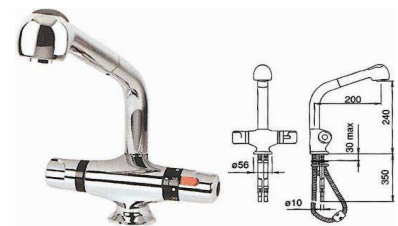
VEIKALS IZPĀRDOŠANA

		EUR	EUR		
	1062	<b>95.11</b>	<b>38.00</b>	Vannas krāns 0102252	
	PANTHER (matēts)		<b>-60%</b>		
		<b>35</b>			
	1066	<b>143.87</b>	<b>57.00</b>	Vannas krāns ar grozāmu izteku 300 mm 0102250	
	PANTHER (matēts)		<b>-60%</b>		
		<b>5</b>			
	1072	<b>80.62</b>	<b>32.00</b>	Dušas krāns 0102257	
	PANTHER (matēts)		<b>-60%</b>		
		<b>21</b>			
	612 ( izteka 18x150 )	<b>14.03</b>	<del>23.48</del>	ABS 0101091	
		<b>15.30</b>	<del>26.08</del>	ORCHIDEA 0101092	
	624 ( izteka 18x200 )	<b>14.71</b>	<del>24.55</del>	ABS 0101118	
		<b>16.41</b>	<del>27.17</del>	ORCHIDEA 0101119	
		<b>7</b>			
	1069-130	<b>21.00</b>	<del>47.88</del>	Keramiskās izlietnes krāns PANTHER 0102224	
		<b>21.00</b>	<del>47.88</del>	RING 0102225	
			<b>5</b>	<b>-56%</b>	

**JAUCĒJKRĀNI FARIS**
**VAIRUMCENA CENA AR ATLAIDI**







	211.93	<del>230.51</del>	93.50	0105005
	<b>1</b>		<b>-55%</b>	
<i>Virtuves izlietnes krāns ar dušu</i>				
	6110	<del>155.70</del>	75.00	0101251
	<b>1</b>		<b>-52%</b>	
<i>Vannas krāns</i>				
	8050	<del>109.14</del>	49.90	0102032
	<b>4</b>	<b>Hroms/zelts</b>		
<i>Vannas jaucējkrāns</i>				
	8050	<del>84.34</del>	49.90	0102103
	<b>15</b>	<b>Hroms</b>		
<i>Vannas jaucējkrāns</i>				
	8100	<del>70.69</del>	40.97	0102106
	<b>12</b>	<b>Hroms</b>		
<i>Keramiskās izlietnes jaucējkrāns</i>				
	8200	<del>93.02</del>	42.50	0102038
	<b>8</b>	<b>Hroms</b>		
<i>Bidē jaucējkrāns</i>				

**JAUCĒJKRĀNI SĒRIJA ARIAL: SORGENTE**
**VEIKALS**

	12000 <b>4</b>	<b>148.82</b>	<b>90.00</b>	0102117 <i>Vannas jaucējkrāns ar komplektu</i>
	12050 <b>2</b>	<b>131.45</b>	<b>82.00</b>	0102222 <i>Vannas jaucējkrāns</i>
	12200 <b>3</b>	<b>99.21</b>	<b>63.00</b>	0102119 <i>Bidē jaucējkrāns</i>
	9050-CA <b>3</b>	<b>81.86</b>	<b>55.00</b>	0102184 <i>Vannas jaucējkrāns</i>
	9250-CA <b>4</b>	<b>88.18</b>	<b>58.00</b>	0102220 <i>Bidē jaucējkrāns</i>







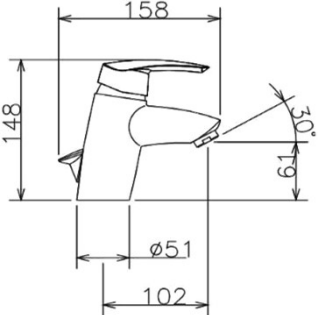

## JAUCĒJKRĀNI SĒRIJA SINTESI. AVANTGARDE

VEIKALS

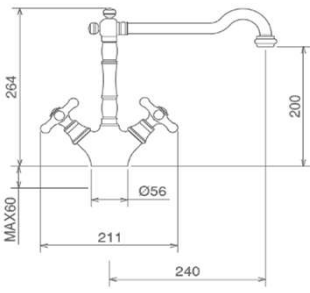
		EUR		
			<i>Vannas jaucējkrāns</i>	
	10020	<del>182.31</del>	<b>123.00</b>	0102109
	2			
			<i>Keramiskās izlietnes jaucējkrāns</i>	
	10100	<del>109.14</del>	<b>74.00</b>	0102112
	3			
			<i>Bidē jaucējkrāns</i>	
	10200	<del>112.85</del>	<b>75.50</b>	0102115
	3			
			<i>Dušas kabīnes jaucējkrāns</i>	
	10400	<del>137.66</del>	<b>93.00</b>	0102116
	1			
			<i>Vannas jaucējkrāns</i>	
	11050/J	<del>70.69</del>	<b>47.50</b>	0102302
	4			
			<i>Bidē jaucējkrāns</i>	
	11200/J	<del>64.49</del>	<b>43.50</b>	0102243
	2			

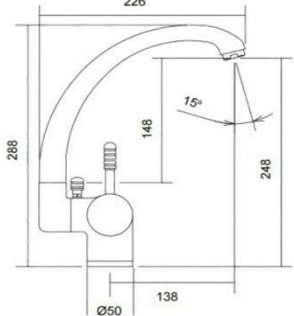
# JAUCĒJKRĀNI SĒRIJA SPLIT; MAXIMA

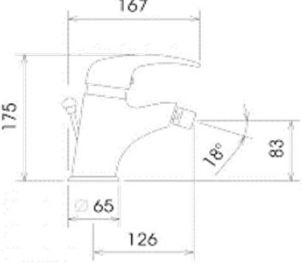

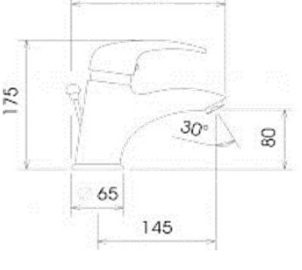



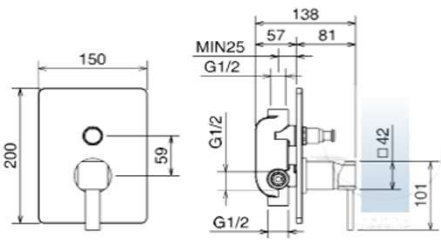

**VEIKALS**

		<p>29001 CS</p> <p>4</p>	<p><b>110.50</b></p>	<p><b>48.85</b></p>	<p><i>Keramiskās izlietnes krāns</i></p> <p>0502194</p>
		<p>23771</p> <p>5</p>	<p><b>249.70</b></p>	<p><b>115.20</b></p>	<p><i>Izlietnes krāns</i></p> <p>0501022</p>
		<p>5114</p> <p>2</p>	<p><b>203.46</b> Hroms/matēts</p>	<p><b>84.00</b></p>	<p><i>Izlietnes jaucējkrāns ar nolocāmu izteku</i></p> <p>0503014</p>
		<p>7010</p> <p>2</p>	<p><b>108.26</b> Hroms</p>	<p><b>57.00</b></p>	<p><i>Bidē jaucējkrāns</i></p> <p>0503021</p>
		<p>7000</p> <p>1</p>	<p><b>149.07</b> Hroms/matēts</p>	<p><b>70.00</b></p>	<p><i>Keramiskās izlietnes jaucējkrāns</i></p> <p>0503025</p>

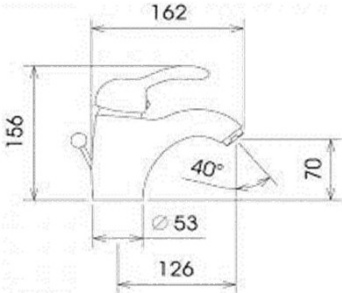

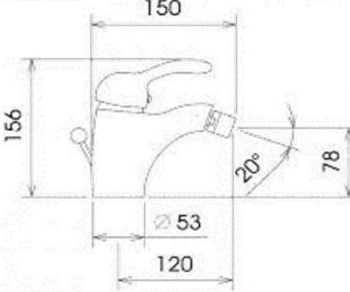

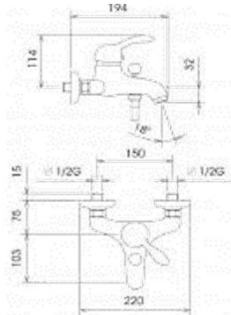

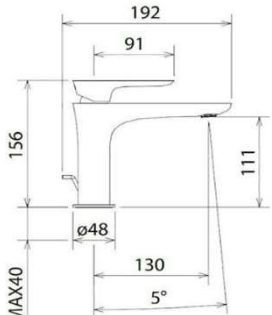





**JAUCĒJKRĀNI SĒRIJA ZEPHYR**

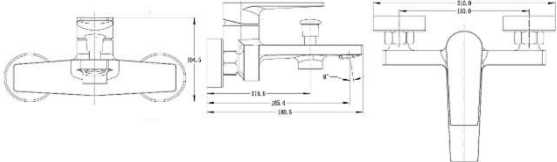

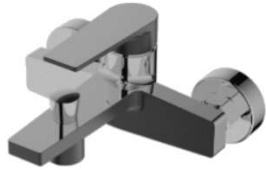
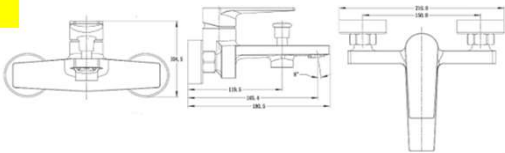
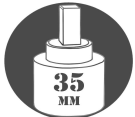





**VEIKALS**

		<p>25080C</p> <p>2</p>	<p><b>119.54</b> <b>HROMS</b></p>	<p><b>55.00</b></p>	<p>0502196</p>
<i>Keramiskās izlietnes jaucējkrāns</i>					
		<p>8001 C</p> <p>2</p>	<p><b>131.62</b> <b>Hroms/matēts</b></p>	<p><b>49.50</b></p>	<p>0503016</p>
<i>Bidē jaucējkrāns</i>					
		<p>8011 c</p> <p>2</p>	<p><b>130.80</b> <b>Hroms/matēts</b></p>	<p><b>49.00</b></p>	<p>0503017</p>
<i>Vannas jaucējkrāns ar komplektu</i>					
		<p>8020</p> <p>12</p>	<p><b>226.63</b> <b>Hroms/matēts</b></p>	<p><b>80.00</b></p>	<p>0503019</p>
<i>Keramiskās izlietnes jaucējkrāns</i>					
	<p>35001TC</p> <p>1</p>	<p><b>184.02</b> <b>HROMS</b></p>	<p><b>88.00</b></p>	<p>0502217</p>	
<i>Keramiskās izlietnes jaucējkrāns</i>					
		<p>44001TC</p> <p>3</p>	<p><b>202.66</b></p>	<p><b>97.00</b></p>	<p>0502086</p>

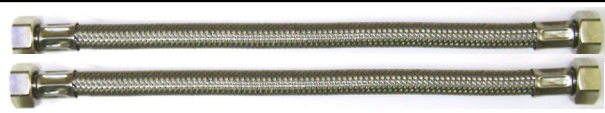
## JAUCĒJKRĀNI AR SVIRAS ROKTURI





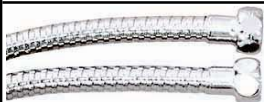





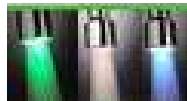

	<b>5</b>	<b>PIRYT</b>	<del>65.87</del> 440-940-00	<b>34.00</b>	<b>0703056</b>
<i>Virtuves izlietnes krāns no sienas</i>					
	<b>28</b>	<b>AMETYST</b>	<del>93.70</del> 406-010-00	<b>43.00</b>	<b>0703003</b>
<i>Dušas krāns</i>					
	<b>38</b>	<b>GRANIT</b>	<del>75.76</del> 486-020-00	<b>39.00</b>	<b>0703016</b>
<i>Dušas krāns</i>					
	<b>15</b>	<b>RUBIN</b>	<del>65.37</del> 566-010-00	<b>34.00</b>	<b>0703050</b>
<i>Dušas krāns</i>					
	<b>1</b>	<b>PIRYT</b>	<del>92.61</del> 443-140-00	<b>46.00</b>	<b>0703058</b>
<i>Virtuves izlietnes krāns</i>					





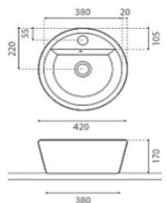

	<b>17</b>	<b>MG6440</b>	<i>Dušas kabīnes jaucējkrāns</i>	<b>24.50</b> <del>52.58</del>	<b>7102116</b>
	<b>31</b>	<b>FS1126-2 BALTS/HROMS</b>	<i>Vannas krāns bez komplekta</i>	<b>28.80</b> <del>89.96</del>	<b>1102004</b>
					
	<b>21</b>	<b>FS1127-2 MELNS/HROMS</b>	<i>Vannas krāns bez komplekta</i>	<b>28.80</b> <del>89.96</del>	<b>1102075</b>
					
	<b>105</b>	<b>MG6480</b>	<i>Bidē jaucējkrāns</i>	<b>22.00</b> <del>49.44</del>	<b>7102114</b>
	<b>57</b>	<b>FS9002-8</b>	<i>Bidē jaucējkrāns</i>	<b>11.00</b> <del>35.00</del>	<b>1103008</b>
	<b>13</b>	<b>FS 9004-8</b>	<i>Bidē jaucējkrāns</i>	<b>11.00</b> <del>33.00</del>	<b>1103053</b>
	<b>9</b>	<b>FS 1435-8</b>	<i>Bidē jaucējkrāns</i>	<b>10.50</b> <del>31.00</del>	<b>1102062</b>
	<b>5</b>	<b>14601 GER</b>	<i>Izlietnes jaucējkrāns</i>	<b>89.00</b> <del>188.68</del>	<b>0501020</b>

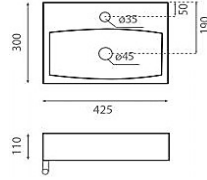

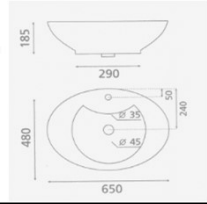

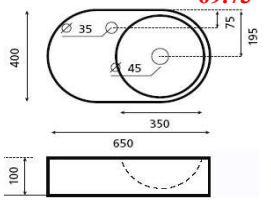

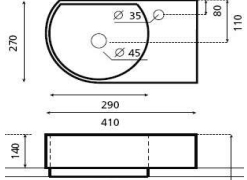

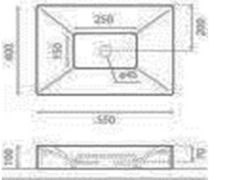
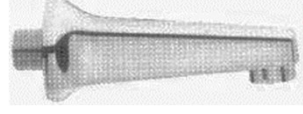

























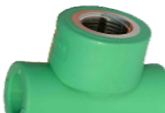

	3/8"	FC2102	<b>1055</b>	<del>0.73</del>	0.50	1110025	Krāna ventilis
		Jaucējkrāna pievadu komplekts (2 gab.) (ķīna) 704 (35) F	<b>71</b>	<del>1.45</del>	1.00	1161002	
		702 (35) F Pievadu komplekts (2 gab.) (ķīna)	<b>795</b>	<del>0.87</del>	0.60	1161001	
		Dušas galva (misina), kvadrāts 19 cm FX19139	<b>16</b>	<del>60.51</del>	36.55	1139018	
	705	30 FM 40 FM	<b>25</b> <b>17</b>	<del>3.76</del> <del>4.32</del>	<del>2.59</del> <del>2.98</del>	<b>0161001</b> <b>0161002</b>	Lokanie pievadi, vara
	710 Vienkāršā pinuma	1/2"x3/4"	<b>25</b>	<del>3.94</del>	2.72	0110056	FARIS
	01001 (200) Dubultais pinums ar konusu, hromēta		<b>98</b>	<del>12.33</del>	8.50	0410005	FLEXTON
	01001 (150) BL Dubultais pinums ar konusu, ar vienu metrisko vītņi		<b>7</b>	<del>7.83</del>	5.40	0410038	
	01006 (200) Dubultā pinuma		<b>1</b>	<del>8.99</del>	6.20	0410012	FLEXTON
	01010 (150) Vienkāršais pinums ar konusu, hromēts		<b>168</b>	<del>8.58</del>	4.10	0410007	FLEXTON
	01010 (200) Vienkāršais pinums ar konusu		<b>31</b>	<del>8.85</del>	6.10	0410015	
	01014 (150) Vienkāršais pinums		<b>7</b>	<del>5.80</del>	4.00	0410013	FLEXTON
	01014 (150) BL Vienkāršais pinums ar vienu metrisko vītņi		<b>87</b>	<del>5.66</del>	3.90	0410036	
	01014 (150) Vienkāršais pinums ar divām metriskām vītņēm		<b>15</b>	<del>5.37</del>	3.70	0410011	
	01014 (150) BL Vienkāršais pinums ar divām metriskām vītņēm		<b>82</b>	<del>5.95</del>	4.10	0410035	
	01014 (200) Vienkāršais pinums		<b>28</b>	<del>8.41</del>	5.80	0410016	

# DUŠAS KLAUSULES UN GALVAS IZPĀRDOŠANA

<p style="text-align: center;"><i>Dušas klausule ar temperatūras displeju</i> FX11108</p> <div style="display: flex; justify-content: space-between;"> <span>Hroms</span> <span style="color: red;">7.99</span> <span>4839028</span> </div> <div style="text-align: center; margin-top: 5px;"> <span style="color: red; font-weight: bold;"><del>12.38</del></span> </div> <div style="text-align: center; margin-top: 10px;"> <span style="background-color: yellow; padding: 2px 10px; font-weight: bold;">364</span> </div> 	<p style="text-align: center;">2B043 <i>Dušas stienis, komplektā</i></p> <div style="display: flex; justify-content: space-between;"> <span>Hroms</span> <span style="color: red;">47.99</span> <span>0430088</span> </div> <div style="text-align: center; margin-top: 5px;"> <span style="color: red; font-weight: bold;"><del>74.38</del></span> </div> <div style="text-align: center; margin-top: 10px;"> <span style="background-color: yellow; padding: 2px 10px; font-weight: bold;">2</span> </div> 
<div style="background-color: yellow; padding: 2px 5px; font-weight: bold; margin-bottom: 5px;">ITĀLIJA</div> <p style="text-align: center;">00054 <i>TWISTER - 3</i></p> <div style="display: flex; justify-content: space-between;"> <span>Hroms</span> <span style="color: red;">9.99</span> <span>0439022</span> </div> <div style="text-align: center; margin-top: 5px;"> <span style="color: red; font-weight: bold;"><del>15.48</del></span> </div> <div style="text-align: center; margin-top: 10px;"> <span style="background-color: yellow; padding: 2px 10px; font-weight: bold;">3</span> </div> 	<p style="text-align: center;">15000 <i>Dušas stienis (plakans) ar ziepju trauku</i></p> <div style="display: flex; justify-content: space-between;"> <span>Hroms</span> <span style="color: red;">18.99</span> <span>0430009</span> </div> <div style="text-align: center; margin-top: 5px;"> <span style="color: red; font-weight: bold;"><del>29.43</del></span> </div> <div style="text-align: center; margin-top: 10px;"> <span style="background-color: yellow; padding: 2px 10px; font-weight: bold;">12</span> </div> 
<div style="background-color: yellow; padding: 2px 5px; font-weight: bold; margin-bottom: 5px;">ITĀLIJA</div> <p style="text-align: center;">00098 <i>Cobra - 1 Big</i></p> <div style="display: flex; justify-content: space-between;"> <span>Hroms</span> <span style="color: red;">9.99</span> <span>0439004</span> </div> <div style="text-align: center; margin-top: 5px;"> <span style="color: red; font-weight: bold;"><del>15.48</del></span> </div> <div style="text-align: center; margin-top: 10px;"> <span style="background-color: yellow; padding: 2px 10px; font-weight: bold;">3</span> </div> 	<p style="text-align: center;">32053 <i>Dušas stienis, komplektā</i></p> <div style="display: flex; justify-content: space-between;"> <span>Hroms/zelts</span> <span style="color: red;">35.99</span> <span>0430086</span> </div> <div style="text-align: center; margin-top: 5px;"> <span style="color: red; font-weight: bold;"><del>55.78</del></span> </div> <div style="text-align: center; margin-top: 10px;"> <span style="background-color: yellow; padding: 2px 10px; font-weight: bold;">10</span> </div> 
<p style="text-align: center;"><i>Klausule ar LED apgaismojumu</i> FX3729</p> <div style="display: flex; justify-content: space-between;"> <span></span> <span style="color: red;">5.50</span> <span>4839020</span> </div> <div style="text-align: center; margin-top: 5px;"> <span style="color: red; font-weight: bold;"><del>8.53</del></span> </div> <div style="text-align: center; margin-top: 10px;"> <span style="background-color: yellow; padding: 2px 10px; font-weight: bold;">60</span> </div> 	<p style="text-align: center;">26225B30 <i>Dušas stienis, komplektā</i></p> <div style="display: flex; justify-content: space-between;"> <span>Hroms</span> <span style="color: red;">19.99</span> <span>0430066</span> </div> <div style="text-align: center; margin-top: 5px;"> <span style="color: red; font-weight: bold;"><del>30.98</del></span> </div> <div style="text-align: center; margin-top: 10px;"> <span style="background-color: yellow; padding: 2px 10px; font-weight: bold;">14</span> </div> 
<div style="display: flex; justify-content: space-around;">    </div> <div style="text-align: center; margin-top: 10px;">  </div>	<p style="text-align: center;">26239B10 <i>Dušas stienis, komplektā</i></p> <div style="display: flex; justify-content: space-between;"> <span>Hroms</span> <span style="color: red;">14.99</span> <span>0430067</span> </div> <div style="text-align: center; margin-top: 5px;"> <span style="color: red; font-weight: bold;"><del>23.23</del></span> </div> <div style="text-align: center; margin-top: 10px;"> <span style="background-color: yellow; padding: 2px 10px; font-weight: bold;">6</span> </div> 

	<i>Sietiņš krānam ar LED apgaismojumu</i>	<b>137</b>	<b>12.24</b> 6.08	4810016
	8 l/min <i>Ūdens plūsmas reduktors</i>	<b>507 ECO</b> <b>2</b>	<b>5.20</b> 2.06	2110020
	050 <i>Rokturis krānam LIBERTY</i>	<b>21</b>	<b>7.38</b> 2.88	0110033
	052 <i>Uzlika ventilim</i>	<b>28</b>	<b>3.86</b> 1.13	0110034
	<b>MATĒTS</b> 070 180x130xØ25 <i>Izteka izlietnes krānam</i>	<b>22</b>	<b>35.30</b> 9.99	0110189
	823-122-00 <i>Dušas pārslēdzējs</i>	<b>13</b>	<b>14.81</b> 8.89	0710006
	907 1,1/2" <i>Misiņa traps vannas sifonam</i>	<b>5</b>	<b>21.47</b> 7.20	0140003
	18/9 <i>Kaučuka izolācija</i>	<b>114</b>	<b>0.65</b> 0.41	2381003
	<i>Dvieļu žāvētājs "P" veida</i> L-500; C-700; 1" <i>cinkotais</i>	<b>10</b>	<b>49.99</b> 19.54	3660251
	4056 <b>FLORENCIA-A</b>	<b>1</b>	<b>123.73</b> 56.05	8575072
				
	4902 <b>RHIN</b>	<b>1</b>	<b>126.44</b> 65.82	8575061
				

	0003 <b>ATHENAS</b>	<b>1</b>	<b>140.65</b> 59.96	8575020
				
	0065 <b>MARBELLA</b>	<b>1</b>	<b>149.42</b> 69.73	8575026
				
	0069 <b>MANISES</b>	<b>1</b>	<b>105.26</b> 48.81	8575033
				
	4039 <b>QUADROS</b>	<b>1</b>	<b>207.98</b> 97.28	8575056
				
	<i>Izteka zemapmetuma vannas krānam</i> 082	<b>1</b>	<b>22.00</b> 7.41	0110143

MAGMA UZSKAITES KODS	PIEGĀDĀTĀ JA KODS	ATTĒLS	NOSAUKUMS	MODELIS	SKAITS	KATALOGA CENA	IZPĀRDOŠANAS CENA BEZ PVN	SUMMA IEPĒRKOT VISU ATLIKUMU
3936203	930		PPR caurule dn32x5.4mm, 930 (zaļa)	DN32X5.4	96	<del>1.90</del>	0.9818	73.3091
3936205	930		PPR caurule dn50x8.4mm, 930 (zaļa)	DN50X8.4	16	<del>4.54</del>	2.3281	28.9719
3936176	951		PPR caurule ar stiklašķiedru 63x10.5 951	DN63 ZAĻA	28	<del>8.90</del>	4.5967	100.1058
3936225	931		PPR līkums 45° I-I dn20, 931 (zaļš)	DN20	193	<del>0.12</del>	0.0595	8.9322
3936228	931		PPR līkums 45° I-I dn40, 931 (zaļš)	DN40	62	<del>0.45</del>	0.2306	11.1190
3936229	931		PPR līkums 45° I-I dn50, 931 (zaļš)	DN50	15	<del>1.12</del>	0.5802	6.7686
3936213	931		PPR līkums 90° I-I dn20, 931 (zaļš)	DN20	1	<del>0.13</del>	0.0527	0.0460
3936257	931		PPR līkums 90° I-Ā dn25, 931 (zaļš)	DN25	69	<del>0.22</del>	0.1116	5.9876
3936280	932		PPR līk.ar sienas stipr.20x3/4, 932 zaļš	20X3/4F	78	<del>2.09</del>	1.0785	65.4298
3936235	933		PPR mufe ar pāreju 32/25, 933 (zaļa)	32/25	160	<del>0.16</del>	0.0818	10.1818
3936237	933		PPR mufe ar pāreju 40/25, 933 (zaļa)	40/25	187	<del>0.26</del>	0.1339	19.4727
3936238	933		PPR mufe ar pāreju 40/32, 933 (zaļa)	40/32	78	<del>0.27</del>	0.1413	8.5736
3936239	933		PPR mufe ar pāreju 50/20, 933 (zaļa)	50/20	20	<del>0.45</del>	0.2306	3.5868
3936240	933		PPR mufe ar pāreju 50/25, 933 (zaļa)	50/25	18	<del>0.45</del>	0.2306	3.2281
3936241	933		PPR mufe ar pāreju 50/32, 933 (zaļa)	50/32	33	<del>0.48</del>	0.2455	6.3000
3936242	933		PPR mufe ar pāreju 50/40, 933 (zaļa)	50/40	6	<del>0.50</del>	0.2603	1.2149
3936243	933		PPR mufe ar pāreju 63/25, 933 (zaļa)	63/25	20	<del>0.68</del>	0.3496	5.4380
3936244	933		PPR mufe ar pāreju 63/32, 933 (zaļa)	63/32	20	<del>0.69</del>	0.3570	5.5537
3936245	933		PPR mufe ar pāreju 63/40, 933 (zaļa)	63/40	20	<del>0.71</del>	0.3645	5.6694
3936246	933		PPR mufe ar pāreju 63/50, 933 (zaļa)	63/50	20	<del>0.73</del>	0.3793	5.9008
3936230	934		PPR trejgabals-pāreja 20/20/25, 934 zaļš	20/20/25	8	<del>0.45</del>	0.2306	1.4347
3936192	934		PPR trejgabals-pāreja 32/20/32 934(zaļš)	32/20/32	126	<del>0.37</del>	0.1934	18.9521
3936222	934		PPR trejgabals dn40, 934 (zaļš)	DN40	63	<del>0.84</del>	0.4314	21.1388
3936224	934		PPR trejgabals dn63, 934 (zaļš)	DN63	20	<del>2.29</del>	1.1826	18.3967
3936269	935		PPR trejgabals IV 20x1/2, 935 (zaļš)	20X1/2F	33	<del>0.79</del>	0.4091	10.5000
3936270	935		PPR trejgabals IV 20x3/4, 935 (zaļš)	20X3/4F	25	<del>1.24</del>	0.6397	12.4380
3936274	935		PPR trejgabals ĀV 20x1/2, 935 (zaļš)	20X1/2M	18	<del>1.18</del>	0.6099	8.5388
3936275	935		PPR trejgabals ĀV 20x3/4, 935 (zaļš)	20X3/4M	125	<del>1.54</del>	0.7959	77.3760
3936276	935		PPR trejgabals ĀV 25x3/4, 935 (zaļš)	25X3/4M	18	<del>1.63</del>	0.8405	11.7669
3936278	935		PPR trejgabals ĀV 32x1, 935 (zaļš)	32X1M	43	<del>3.82</del>	1.9711	65.9215
3936253	936		PPR apeja dn20, 936 (zaļa)	DN20	247	<del>0.45</del>	0.2306	44.2967
3936254	936		PPR apeja dn25, 936 (zaļa)	DN25	162	<del>0.55</del>	0.2826	35.6132
3936255	936		PPR apeja dn32, 936 (zaļa)	DN32	8	<del>1.02</del>	0.5281	3.2860
3936260	937		PPR līkums 90° IV 20x3/4, 937 (zaļš)	20X3/4F	33	<del>1.43</del>	0.7364	18.9000
3936264	937		PPR līkums 90° ĀV 20x1/2, 937 (zaļš)	20X1/2M	59	<del>1.14</del>	0.5876	26.9645
3936265	937		PPR līkums 90° ĀV 20x3/4, 937 (zaļš)	20X3/4M	54	<del>1.71</del>	0.8851	37.1752
3936267	937		PPR līkums 90° ĀV 25x1/2, 937 (zaļš)	25X1/2M	186	<del>1.40</del>	0.7215	104.3752



















3936210	938		PPR mufe dn40, 938 (zaļa)	DN40	167	<del>0.37</del>	0.1934	25.1190
3936211	938		PPR mufe dn50, 938 (zaļa)	DN50	37	<del>0.72</del>	0.3719	10.7025
3936212	938		PPR mufe dn63, 938 (zaļa)	DN63	17	<del>1.27</del>	0.6545	8.6545
3936247	940		PPR korķis dn20, 940 (zaļš)	DN20	580	<del>0.09</del>	0.0446	20.1322
3936248	940		PPR korķis dn25, 940 (zaļš)	DN25	658	<del>0.10</del>	0.0521	26.6463
3936250	940		PPR korķis dn40, 940 (zaļš)	DN40	360	<del>0.30</del>	0.1562	43.7355
3936251	940		PPR korķis dn50, 940 (zaļš)	DN50	20	<del>0.96</del>	0.4983	7.7521
3936252	940		PPR korķis dn63, 940 (zaļš)	DN63	116	<del>1.09</del>	0.5653	51.0017
3936283	941		PPR pāreja IV 20x1/2, 941 (zaļa)	20X1/2F	3	<del>0.94</del>	0.4835	1.1281
3936286	941		PPR pāreja IV 25x1/2, 941 (zaļa)	25X1/2F	1	<del>0.91</del>	0.4686	0.3645
3936289	941		PPR pāreja IV 50x11/2, 941 (zaļa)	50X11/2F	52	<del>5.76</del>	2.9752	120.3306
3936292	941		PPR pāreja ĀV 20x3/4, 941 (zaļa)	20X3/4M	211	<del>1.35</del>	0.6992	114.7421
3936297	941		PPR pāreja ĀV 50x11/2, 941 (zaļa)	50X11/2M	24	<del>5.75</del>	2.9678	55.3983
3936298	941		PPR pāreja ĀV 63x2, 941 (zaļa)	63X2M	21	<del>9.13</del>	4.7157	77.0231
3936188	945		PPR izjauicama uzmava IV20x1/2" 945(zaļa)	20X1/2F	291	<del>1.31</del>	0.6769	153.1959
3936189	945		PPR izjauicama uzmava IV25x3/4" 945(zaļa)	25X3/4F	182	<del>1.83</del>	0.9446	133.7174
3936190	946		PPR izjauicama uzmava ĀV20x1/2" 946(zaļa)	20X1/2M	265	<del>1.80</del>	0.9298	191.6322
3936191	946		PPR izjauicama uzmava ĀV25x3/4" 946(zaļa)	25X3/4M	190	<del>2.75</del>	1.4207	209.9421
3936199	949		PPR pāreja ar saskrūvi IV 949 (zaļa)	32X11/4F	3	<del>9.60</del>	4.9612	11.5760
3936300	949		PPR pāreja ar saskrūvi IV 949 (zaļa)	25X1F	9	<del>6.90</del>	3.5628	24.9397
3936196	950		PPR korķis 950 (zaļš), iekšējais	DN20	36	<del>0.27</del>	0.1413	3.9570
3936197	950		PPR korķis 950 (zaļš), iekšējais	DN25	180	<del>0.29</del>	0.1488	20.8264
3936198	950		PPR korķis 950 (zaļš), iekšējais	DN32	174	<del>0.29</del>	0.1488	20.1322

2225.5138

				<i>Klipšveida stiprinājums siltajām grīdām</i>	
	15-20 mm	01990	388	<b>0.05</b>	<b>1722033</b>
	15-20 mm	01995	336	<b>0.06</b>	<b>1722034</b>
	9826ZK			<i>Klipšveida turētājs (zaļš)</i>	
	20-22 mm	100	2137	<b>0.03</b>	<b>7622001</b>
	24-25 mm	50	687	<b>0.03</b>	<b>7622002</b>
	32 mm	50	951	<b>0.03</b>	<b>7622003</b>
	9827AK			<i>Klipšveida stiprinājums dubultais</i>	
	10	100	85	<b>0.10</b>	<b>1722007</b>
	01860P			<i>Cauruļu stiprinājums ar dībeļnagli</i>	
	25mm	200	1122	<b>0.08</b>	<b>1722031</b>
	01970P			<i>Cauruļu stiprinājums ar dībeļnagli dubults</i>	
	25mm	100	47	<b>0.10</b>	<b>1722032</b>
	9826FK			<i>Klipšveida turētājs</i>	
	15-18	50	49	<b>0.09</b>	<b>1722036</b>

















			GAB.	EUR		
	3901F	<i>Kompresijas savienojums ar ārējo vītņi</i>	3/4"x16	46	<del>1.62</del> 0.98	9519017
			1"x26	73	<del>2.76</del> 1.67	6419034
	3902F	<i>Kompresijas savienojums ar iekšējo vītņi</i>	1"x26	38	<del>2.85</del> 1.73	6419036
	3903F	<i>Kompresijas uzstāve</i>	16x20	274	<del>2.52</del> 1.53	9519020
			26x26	41	<del>3.94</del> 2.39	6419037
	3931F	<i>Kompresijas trejgabals</i>	20x16x20	672	<del>3.35</del> 2.03	9519010
			16x20x16	865	<del>3.53</del> 2.14	9519022
			20x16x16	920	<del>3.53</del> 2.14	9519023
			20x20x16	926	<del>4.03</del> 2.44	9519024
			26x20x26	40	<del>8.28</del> 5.02	6419039
			26x26x26	32	<del>5.53</del> 3.35	6419038
	3932F	<i>Kompresijas trejgabals ar iekšējo vītņi</i>	16x3/4"x16	916	<del>3.35</del> 2.03	9519031
			20x3/4"x20	430	<del>4.34</del> 2.63	9519032
			26x3/4"x26	32	<del>4.93</del> 2.99	6419043
			26x1"x26	40	<del>5.33</del> 3.23	6419044
	3933F	<i>Kompresijas trejgabals ar ārējo vītņi</i>	16x3/4"x16	921	<del>2.85</del> 1.73	9519015
			20x3/4"x20	589	<del>4.34</del> 2.63	9519016
			26x3/4"x26	35	<del>4.36</del> 2.64	6419045
			26x1"x26	40	<del>5.33</del> 3.23	6419046
	3952F	<i>Kompresijas līkums ar iekšējo vītņi</i>	3/4"x16	705	<del>2.16</del> 1.31	9519028
			3/4"x26	63	<del>3.09</del> 1.87	6419040
			1"x26	56	<del>3.65</del> 2.21	6419041
	3953F	<i>Kompresijas līkums ar ārējo vītņi</i>	3/4"x16	713	<del>1.98</del> 1.20	9519012
			3/4"x20	336	<del>2.48</del> 1.50	9519014
			3/4"x26	50	<del>2.85</del> 1.73	6419047
			1"x26	49	<del>3.25</del> 1.97	6419048
	3954F	<i>Kompresijas līkums ar sienas stiprinājumu</i>	1/2"x20	98	<del>2.51</del> 1.52	6419030
			3/4"x16	45	<del>2.46</del> 1.49	6419029
	4002 F	<i>Presējams savienojums ar iekšējo vītņi</i>	1/2"x16	58	<del>1.55</del> 0.94	6419003

			GAB.	EUR		
	4033 F	<i>Presējams trejgabals ar ārējo vītņi</i>	16x1/2"x16	41	<del>2.52</del> 1.53	6419024
	3813 M	<i>Kalibrators</i>	D16	1	<del>11.39</del>	6435003
			D20	1	<del>6.94</del>	6435001
			D26	1	<del>6.94</del>	6435002
			D12-16	1	<del>11.45</del>	6435005
	3813	<i>Kalibrators</i>		1	<del>3.53</del>	0935001
	921 PPR	<i>Skēres caurulēm 0-42mm nerūsējoša tērauda asmenis</i>			<del>14.73</del>	3435001
					<del>14.46</del>	3435002
	100902	<i>Prese D16-32, mehāniskā</i>				
			U-gali	16-32	1	<del>200.33</del>
			TH-gali	16-32		
	3811 F	<i>Prese D16-20, mehāniskā</i>				
			16-20	1	<del>148.00</del>	7635013
	7271F	<i>PEX-AL-PEX caurule</i>				
		<i>KĶina</i>	26x3.0	50 m	<del>1.63</del>	9519037
	7271	<i>PEX-AL-PEX caurule</i>				
		<i>Itālija</i>	16x2.0	100 m	<del>1.47</del>	0919130
			20x2.0	100 m	<del>2.19</del>	0919131
			26x3.0	50 m	<del>4.14</del>	0919132
	8595/96	<i>Liekšanas spirāle, ārējā</i>				
			16mm		<del>5.14</del>	2135001
			20mm		<del>8.61</del>	2135002

GAB.

EUR

	<b>7951</b>	<i>Lodveida ventilis (I-I)</i>			
4"	1	<del>167.25</del>	111.50	0620102	
	<b>7956</b>	<i>Lodveida ventilis</i>			
Ø15	110	<del>6.38</del>	3.45	0620106	
Ø22	74	<del>8.18</del>	5.14	0620107	
Ø28	63	<del>14.55</del>	7.51	0620108	
	<b>7615</b>	<i>Lodveida ventilis ar atgaisotāju</i>			
3/4"	36	<del>6.90</del>	4.60	0620043	
1,1/4"	6	<del>14.63</del>	9.75	0620045	
1,1/2"	22	<del>20.10</del>	13.40	0620046	
2"	9	<del>25.50</del>	17.00	0620047	
	<b>7620</b>	<i>Lodveida trīscelņu ventilis</i>			
1,1/4"	15	<del>56.40</del>	37.60	0620035	
1,1/2"	17	<del>100.80</del>	67.20	0620036	
2"	12	<del>153.00</del>	102.00	0620037	
	<b>SLD1016</b>	<i>Lodveida ventilis ar pieslēguzgriezni</i>			
1.1/4"	403	<del>8.23</del>		9620004	
	<b>SLD204</b>	<i>Dārza krāns</i>			
1"	1121	<del>3.60</del>		9620027	
	<b>1010</b>	<i>Pretvārsts bez sieta</i>			
4"	1	<del>58.35</del>	38.90	0620118	
	<b>5230</b>	<i>Aizbīdnis</i>			
2,1/2"	3	<del>27.3</del>	18.20	0620122	
3"	2	<del>36.45</del>	24.30	0620123	

	<b>244-030-00</b>	<i>Stūra ventilis 1/2"x3/8"</i>			
	10	<del>13.90</del>	6.89	0720003	
	<b>244-010-00</b>	<i>Stūra ventilis 1/2"x3/8"</i>			
	1	<del>9.96</del>	4.73	0720001	
	<b>3621</b>	<i>Atgaisotāja pretvārsts</i>			
1/2"	2	<del>0.90</del>	0.60	0620092	
	<b>4025</b>	<i>Saskrūve ar pretvārstu</i>			
3/4"	47	<del>11.22</del>	7.48	0925315	
	<b>KAS0405310</b>	<i>Radiatora ventilis, leņķa</i>			
3/4"	158	<del>5.45</del>	2.67	3920002	
	<b>KAS1314014</b>	<i>Termo ventilis, leņķa, PEX Bez galvas</i>			
1/2"	1	<del>6.37</del>	2.73	3920008	
	<b>KAS8102005</b>	<i>Termo galva, hromēta</i>			
1/2"	62	<del>14.92</del>	7.41	3920006	

*Poga, WC kastei melns matēts*  
9240407 **120.10**  
**1** 68.01 4771028

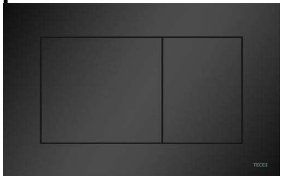

*WC modulis 9300302*  
9300302 **277.70**  
**1** 158.98 4771029

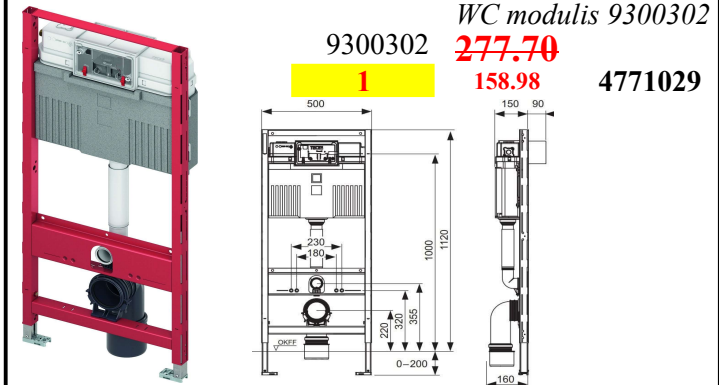

*Termostata vārsta galva M28x1.5*  
1920003 **13.84**  
**4** 8.34 6320122



*Termost.galva un vārsts atpak.t.*  
1920123 **37.22**  
**8** 22.39 6320123



*Savienojums plastm. caurulei*  
1609809 **3.46** 20X2.8MM  
**1** 2.08 6319027



*Savienojums plastm. caurulei*  
1609819 **3.46** 20X3.4MM  
**2** 2.08 6319028



*Atpakaļgaitas 3-ceļu vārsts 1"*  
1776603 **63.23**  
**2** 38.06 6320204



*Jaucējvārsts ar rokt.3-ceļu 1 1/2*  
1213705 **111.45**  
**1** 64.65 6320149



*Balansēšanas vārsts STROMAX M1/2"*  
2411751 **25.32**  
**2** 15.24 6320231



*Termostata vārsts, aksiāls 1/2"*  
1772811 **20.75**  
**3** 12.49 6320101

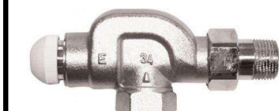

*Dekoratīvās uzlikas caurulēm T-stūra*  
S682201 **17.12**  
**2** 10.31 6310003

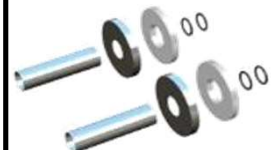

*Dekoratīvās uzlikas caurulēm, apaļas*  
S682200 **15.03**  
**2** 9.05 6310004

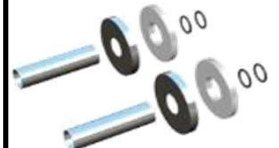

*Pāreja M22X1/2 IV, misiņš*  
S622022 **16.58**  
**2** 9.98 6319009



*Līkuma vadula D14-18mm*  
3F11008 **1.16**  
**30** 0.62 6319035



*Radiatoru pieslēgš.mezgls 3/4"*  
1376621 **10.89** Project  
**5** 6.55 6320044



*Radiatoru pieslēg.mezgls 1/2X3/4*  
1376622 **12.40** Project  
**9** 7.47 6320046



*X-veida savienojums 3/4"*  
1300434 **15.64**  
**12** 9.42 6320052



*Spiediena reduktors 1/2"*  
1268211 **71.09**  
**1** 40.62 6320054













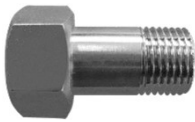









*Telpas termostats 230V, bimet.*  
3F79100 **18.73**  
**3** 11.27 6320081



*Lodveida krāns sūkņim ar pretv. 1"*  
1226803 **30.68**  
**1** 18.25 6320086

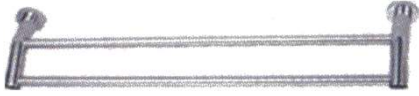

	Reg. lodveida 2-ceļu vārsts 1" 1211703 <b>33.05</b> 1 19.30 6320093		Lodveida krāns ar aizsargplombi 1210502 <b>13.78</b> 4 7.63 6320210
	Termostata vārsts 1/2" 1762367 <b>15.03</b> 1 9.05 6320212		Saskrūve ar konusa blīvslēgu 1/2 1621021 <b>3.47</b> 10 2.10 6320216
	Atgaisotājs automātiskais 1/2" 1263001 <b>11.41</b> 2 6.12 6320111		Atpakaļgaitas termost.ventilis 1/2" 1776051 <b>29.14</b> 1 17.53 6320232
	Termostats ar kontaktsensoru 1742100 <b>41.00</b> 1 24.68 6320115		Radiatora ventilis, taisns 1/2" AV 1553711 <b>13.47</b> 10 8.11 6320250
	Drošības vārsts 3/4" 1260502 <b>9.21</b> 5 5.32 6320138		Savienojums kapara caurulei 1627403 <b>3.46</b> 4 2.08 6325009 M22x1.5
	Termostata 3-ceļu vārsts CALIS-TS kreisais 1774502 <b>32.84</b> 1 19.77 6320144		Apkures kolektors 3 sūkņa grupām DN25 1450112 <b>335.15</b> 1 190.78 6334050
	Termostata 3-ceļu vārsts CALIS-TS labais 1774602 <b>32.84</b> 2 19.77 6320145		Kolektors viencauruļu sistēm.ar nipeļiem 1316612 <b>24.72</b> 2 14.88 6334052
	Termostata 2-ceļu vārsts 4-gaitas 1/2"taisns 1778341 <b>29.10</b> 1 17.52 6320185		Montāžas atslēga savien.3/8"-3/4" 1668000 <b>16.47</b> 2 9.92 6335001
	Termostata 2-ceļu vārsts 4-gaitas 1/2"līks 1778441 <b>29.89</b> 1 17.99 6320186		Termomotoru adapteris, balts (7760/62/63) M30x1.5 1770898 <b>2.25</b> 5 1.35 6397011
	Jaucējvārsts ar rokt.4-ceļu 1" 1213803 <b>51.55</b> 1 29.51 6320196		
	Termostata vārsta adapteris M30x1.5 1635711 <b>5.66</b> 2 3.40 6320203		









	EUR			EUR	
<b>82611C</b> <i>Ziepju trauks</i> 	<del>8.20</del>	1131057	90	<b>3.50</b>	
<b>82624C</b> <i>Stienis dvieļiem (60 cm)</i> 	<del>14.93</del>	1131021	93	<b>9.50</b>	
<b>82624DC</b> <i>Dubultais stienis dvieļiem (60 cm)</i> 	<del>24.26</del>	1131022	68	<b>16.00</b>	
<b>82680C</b> <i>Riņķis dvieļiem</i> 	<del>6.80</del>	1131023	34	<b>4.30</b>	
<b>82684DC</b> <i>Dubulta glāze ar sienas stiprinājumu</i> 	<del>14.02</del>	1131026	77	<b>9.30</b>	
<b>82684C</b> <i>Glāze ar sienas stiprinājumu</i> 	<del>8.53</del>	1131025	81	<b>5.50</b>	
<b>SPL-Y</b> <i>Lampa Y</i> 			39	<del>9.73</del>	9879002
<b>SPL-D3</b> <i>Lampa D3</i> 			2	<del>7.64</del>	9879003
<b>SPL-D39</b> <i>Lampa D39</i> 			7	<del>13.60</del>	9879001
<b>SPL-D240</b> <i>Lampas stikla daļas</i> <b>SPL-D165</b> <i>Lampas stikla daļas</i>	<del>3.37</del> <del>3.37</del>				9879004 9879005
<b>104206262</b> <i>Āķītis, līmējams</i> <i>Ražotājs Bemeta (Čehija)</i> 			6	<del>8.50</del>	8231071

		EUR	
	<b>83724C</b> <i>Stienis dvieļiem (60 cm)</i>	<del>12.67</del>	1131046
		136	<b>6.30</b>
	<b>83780C</b> <b>BLISTERIS</b> <i>Riņķis dvieļiem</i>	<del>5.90</del>	1131049
		14	<b>3.50</b>
	<b>83782C</b> <i>Āķītis dubultais</i>	<del>4.34</del>	1131050
		104	<b>2.65</b>
	<b>83784C</b> <i>Glāze ar</i> <b>BLISTERIS</b>	<del>6.14</del>	1131051
		129	<b>3.60</b>
	<b>83781C</b> <i>Šķidro ziepju trauks ar</i> <b>BLISTERIS</b> <i>turētāju un dozatoru</i>	<del>9.47</del>	7131010
		112	<b>5.30</b>
	<b>83787C</b> <i>Stikla plaukts</i>	<del>12.52</del>	1131048
		170	<b>7.50</b>
	<i>Tualetes papīra turētājs</i> <b>83786C</b>		1131044
		168	<b>7.20</b>

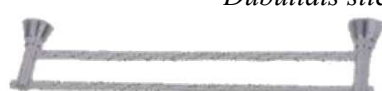
		EUR	
	<b>85011</b> <i>Ziepju trauks, metāla</i>	<del>17.36</del>	1131069
		76	<b>8.50</b>
	<b>85024C</b> <i>Stienis dvieļiem (60 cm)</i>	<del>21.32</del>	1131070
		61	<b>12.00</b>
	<b>85080C</b> <i>Stienis dvieļiem</i>	<del>15.61</del>	1131072
		63	<b>8.80</b>
	<b>85084C</b> <i>Glāze ar sienas stiprinājumu</i>	<del>13.68</del>	1131074
		133	<b>6.30</b>
	<b>85084D</b> <i>Dubulta glāze ar sienas stiprinājumu</i>	<del>19.16</del>	1131077
		13	<b>12.50</b>
	<b>85085</b> <i>Ziepju trauks</i>	<del>13.68</del>	1131075
		20	<b>8.50</b>
	<b>85088</b> <i>Poda birste ar keramikas trauciņu</i>	<del>21.05</del>	1131079
		68	<b>11.00</b>











VEIKALS  
EUR

VEIKALS  
EUR

<p><b>84211C</b> <i>Ziepju trauks, metāla</i></p>  <p><del>16.26</del> 1131034 4 <b>10.20</b></p>
<p><b>84224C</b> <i>Stienis dvieļiem (60 cm)</i></p>  <p><del>27.45</del> 1131031 130 <b>15.00</b></p>
<p><b>84224DC</b> <i>Dubultais stienis dvieļiem (60 cm)</i></p>  <p><del>41.93</del> 1131032 127 <b>20.00</b></p>
<p><b>84280C</b> <i>Stienis dvieļiem</i></p>  <p><del>13.31</del> 1131033 18 <b>8.20</b></p>
<p><b>84284C</b> <i>Glāze ar sienas stiprinājumu</i></p>  <p><del>15.64</del> 1131055 255 <b>7.30</b></p>
<p><b>84284DC</b> <i>Dubulta glāze ar sienas stiprinājumu</i></p>  <p><del>18.22</del> 1131036 67 <b>10.00</b></p>
<p><b>84285C</b> <i>Ziepju trauks (stikla)</i></p>  <p><del>14.53</del> 1131037 218 <b>7.20</b></p>
<p><b>84288C</b> <i>Poda birste ar keramikas trauciņu</i></p>  <p><del>19.76</del> 1131040 69 <b>11.70</b></p>



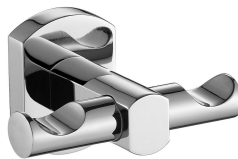

<p><b>84711</b> <i>Ziepju trauks, metāla</i></p>  <p><del>8.48</del> 1131056 307 <b>6.00</b></p>
<p><b>84724C</b> <i>Stienis dvieļiem (60 cm)</i></p>  <p><del>12.68</del> 1131058 205 <b>9.40</b></p>
<p><b>84724DC</b> <i>Dubultais stienis dvieļiem (60 cm)</i></p>  <p><del>21.54</del> 1131059 97 <b>16.00</b></p>
<p><b>84784C</b> <i>Glāze ar sienas stiprinājumu</i></p>  <p><del>7.13</del> 1131062 308 <b>5.30</b></p>
<p><b>84788</b> <i>Poda birste ar keramikas trauciņu</i></p>  <p><del>11.31</del> 1131067 58 <b>8.30</b></p>

## VANNAS ISTABAS AKSESUĀRI

EUR		EUR	
86085	Ziepju trauks	86087	Stikla plaukts
<del>15.02</del> 7131006		<del>24.66</del> 7131001	
214	8.80	120	13.50
86024	Stienis dvieliem (60 cm)	86088	Poda birste ar keramikas trauciņu
<del>23.18</del> 7131007		<del>22.36</del> 7131002	
210	14.00	133	13.50
86081	Šķidro ziepju trauks ar turētāju	H 132	Metāla plauktiņš vannas iztabai
<del>16.57</del> 7131003		320x232x45	
217	10.00	7.33	1131085
86080	Stienis dvieliem	2	5.40
<del>12.90</del> 7131004		Glāze (stikla)	
169	7.80	<del>2.62</del> 1131093	
86082D	Āķītis	112	1.60
<del>10.78</del> 7131008			
30	6.50		
86084	Glāze ar sienas stiprinājumu		
<del>14.70</del> 7131009			
222	8.80		



**"GRAVENA" KERAMIKA (ITĀLIJA)**

	<i>Izlietne keramiskā un puskāja "SMART"</i>			
	Ker.izlietne(piekaramā)60x49 balta-mat.	1	<b>71.00</b> <del>102.00</del>	00.95.12 8075001
	Puskāja 41x28 balta-matēta 00.95.22	1	<b>47.00</b> <del>68.15</del>	00.95.22 8075002
<i>Bidē pods "SMART"</i>				
	Bidē pods(piekaramais)53x35 balts-matēts	3	<b>15.00</b> <del>107.89</del>	00.95.32 8077012
	Bidē (piekaramais), balts	2	<b>15.00</b> <del>85.57</del>	00.95.32 8077038
Attālums starp centriem 230 mm				
<i>WC komplekts "CONIO"</i>				
	Keramiskā izlietne 66x63 dzeltens	2	<b>90.00</b> <del>151.18</del>	00.60.10 8075011
	Postamants ker.izl.70x30 dzeltens	2	<b>57.00</b> <del>96.76</del>	00.60.20 8075012
	Bidē pods 53,5x49x40 dzeltens	2	<b>78.00</b> <del>130.62</del>	00.60.30 8077006
Tirgojam kompleksus, pēc tam atsevišķi				
<i>WC pie sienas "SMART"</i>				
	WC sienas, 00.95.42, SMART, balts	1	<b>52.00</b> <del>85.57</del>	00.95.42 8077026
Tirgojam kompleksus				
<i>Keramiskā izlietne un postaments "GAYA"</i>				
	Postaments ker.izl. 69.5x18.5 pasteļtoni	1	<b>29.00</b> <del>73.17</del>	00.50.20 8075033
	Keramiskā izlietne, 70x50, pasteļtonis	1	<b>56.00</b> <del>145.10</del>	00.50.10 8075034
Tirgojam kompleksus, pēc tam atsevišķi				
<i>WC skalojamā tvertne "CONIO"</i>				
	Skalojamā tvertne, pasteļtonis CONIO	1	<b>10.00</b> <del>92.07</del>	00.60.61 8071012

## TRAPS GRĪDAI AR HIDROIZOLĀCIJU.

1. Viegla montāža
  2. Mazs augstums
  3. Caurplūde no 40-56 l/min
  4. Plāna PVC plēve
  5. Derīgs visām dušām
- Pieejamie izmēri 150 x 180 cm

Cenas (150x180) - ~~116.70~~ EUR **70.00** EUR

Artikuls: 1250036



ATLAIDE 40%

