













































































# SATURS













lpp			lpp			lpp		
1		Lokanie pievadi	101		Lodējamie bronzas veidgabali	154		Pansa radiatori
7		Magma dušas	102		Kompresijas + presējamie veidgabali (Itālija)	156		Podi, Izlietnes keramiskās
10		Jaucējkrāni	104		Kompresijas + presējamie (Ķīna)	159		Isover čaulas
31		Jaucējkrāni	105		Čuguna veidgabali	163		Instrumenti
39		Jaucējkrāni	109		Metināmie veidgabali	164		IBO sūkņi
45		Jaucējkrāni	110		PPR veidgabali	165		Sūkņi Delfin
50		Jaucējkrāni	112		<b>KARBONS</b>	166		Sūkņi "Pedrollo"
54		Jaucējkrāni	113		PE veidgabali	167		Boileri "Atlantic"
56		Dozatori	114		KAS ventīļi	169		Rezerves daļas boileriem
59		Sensorkrāni	115		Bonomi ventīļi	172		GEBO veidgabali
61		Ventīļi, kārtidži	117		Noslēgarmatūra	173		Fenix siltās grīdas
65		Dušu pievadi	118		WTM ventīļi Hromēti ventīļi	175		Virax instrumenti (Francija)
66		Dušu galvas	119		HERZ	177		Gāzes baloni un degļi
68		Dušu stieņi	125		Kanplast iekšdarbu kanalizācija	179		WEKEM ķīmija
70		Nicoll sifoni	127		Alphacan ārdarbu kanalizācija	180		Dušas kabīnes un paliktņi
77		Trapi, noteces	128		Vannas istabas aksesuāri			
81		WC Gofras un veidgabali	133		Batcho izlietnes			
83		WC mehānismi, WC rāmji	138		Aquaphor filtri			
85		Manžetes, skaitītāji	139		Filtri, korpusi			
86		Skrūves, stiprinājumi	141		Dvieļu žāvētāji			
87		Savilcēji, rozetes	146		Elektriskie dvieļu žāvēt.			
88		Blīves	147		Spoguļi			
89		Blīvējumu materiāli	148		Claber virszemes laistīšanas iekārtas			
90		Ķīmija	151		Capricorn Siltās grīdas			
94		Misiņa veidgabali	152		Roku tīrāmie līdzekļi			
99		Kapara veidgabali	153		Feniks iekuri			







701		<i>Lokanais alumīnija pievads ø9x14(1/2"x1/2")</i>					
	FF					FM	
	20	<b>1.98</b>	<b>1061001</b>			20	<b>2.05</b> <b>1061002</b>
	30	<b>2.13</b>	<b>1061003</b>			30	<b>2.20</b> <b>1061004</b>
	40	<b>2.28</b>	<b>1061005</b>			40	<b>2.35</b> <b>1061006</b>
	50	<b>2.40</b>	<b>1061007</b>			50	<b>2.47</b> <b>1061008</b>
	60	<b>2.55</b>	<b>1061009</b>			60	<b>2.62</b> <b>1061010</b>
	70	<b>2.75</b>	<b>1061011</b>			70	<b>2.81</b> <b>1061012</b>
	80	<b>2.93</b>	<b>1061013</b>			80	<b>2.99</b> <b>1061014</b>
	90	<b>3.06</b>	<b>1061015</b>			90	<b>3.13</b> <b>1061016</b>
	100	<b>3.24</b>	<b>1061017</b>			100	<b>3.31</b> <b>1061018</b>
	120	<b>3.69</b>	<b>1061019</b>			120	<b>3.76</b> <b>1061020</b>
	150	<b>4.32</b>	<b>1061021</b>			150	<b>4.40</b> <b>1061022</b>
	180	<b>4.83</b>	<b>1061023</b>			180	<b>4.90</b> <b>1061024</b>
	200	<b>5.34</b>	<b>1061025</b>			200	<b>5.42</b> <b>1061026</b>
	250	<b>6.53</b>	<b>1061027</b>			250	<b>6.61</b> <b>1061028</b>
	300	<b>7.59</b>	<b>1061029</b>			300	<b>7.67</b> <b>1061030</b>
350	<b>8.55</b>	<b>1061031</b>			350	<b>8.63</b> <b>1061032</b>	
702		<i>Lokanais nerūsējošā tērauda pievads ø9x14(1/2"x1/2")</i>					
	FF					FM	
	20	<b>1.97</b>	<b>1061033</b>			20	<b>2.05</b> <b>1061034</b>
	30	<b>2.20</b>	<b>1061035</b>			30	<b>2.27</b> <b>1061036</b>
	40	<b>2.36</b>	<b>1061037</b>			40	<b>2.43</b> <b>1061038</b>
	50	<b>2.54</b>	<b>1061039</b>			50	<b>2.61</b> <b>1061040</b>
	60	<b>2.72</b>	<b>1061041</b>			60	<b>2.79</b> <b>1061042</b>
	70	<b>2.91</b>	<b>1061043</b>			70	<b>2.98</b> <b>1061044</b>
	80	<b>3.09</b>	<b>1061045</b>			80	<b>3.16</b> <b>1061046</b>
	90	<b>3.30</b>	<b>1061047</b>			90	<b>3.37</b> <b>1061048</b>
	100	<b>3.54</b>	<b>1061049</b>			100	<b>3.61</b> <b>1061050</b>
	120	<b>4.01</b>	<b>1061051</b>			120	<b>4.08</b> <b>1061052</b>
	150	<b>4.75</b>	<b>1061053</b>			150	<b>4.82</b> <b>1061054</b>
	180	<b>5.31</b>	<b>1061055</b>			180	<b>5.38</b> <b>1061056</b>
	200	<b>5.77</b>	<b>1061057</b>			200	<b>5.85</b> <b>1061058</b>
	250	<b>7.36</b>	<b>1061059</b>			250	<b>7.44</b> <b>1061060</b>
	300	<b>8.87</b>	<b>1061061</b>			300	<b>8.95</b> <b>1061062</b>
350	<b>10.27</b>	<b>1061063</b>			350	<b>10.36</b> <b>1061064</b>	
702/A		<i>Lokanais nerūsējošā tērauda pievads ar blīvēm ø9x14(1/2"x1/2")</i>					
	FF					FM	
	20	<b>2.03</b>	<b>1061246</b>			20	<b>2.17</b> <b>1061247</b>
	30	<b>2.25</b>	<b>1061248</b>			30	<b>2.38</b> <b>1061249</b>
	40	<b>2.45</b>	<b>1061250</b>			40	<b>2.58</b> <b>1061251</b>
	50	<b>2.67</b>	<b>1061252</b>			50	<b>2.79</b> <b>1061253</b>
	60	<b>2.83</b>	<b>1061254</b>			60	<b>2.96</b> <b>1061255</b>
	70	<b>3.03</b>	<b>1061256</b>			70	<b>3.15</b> <b>1061257</b>
	80	<b>3.22</b>	<b>1061258</b>			80	<b>3.34</b> <b>1061259</b>
	90	<b>3.41</b>	<b>1061260</b>			90	<b>3.53</b> <b>1061261</b>
	100	<b>3.60</b>	<b>1061262</b>			100	<b>3.73</b> <b>1061263</b>
	120	<b>4.07</b>	<b>1061264</b>			120	<b>4.19</b> <b>1061265</b>
	150	<b>4.88</b>	<b>1061266</b>			150	<b>5.00</b> <b>1061267</b>
	180	<b>5.42</b>	<b>1061268</b>			180	<b>5.54</b> <b>1061269</b>
	200	<b>5.88</b>	<b>1061270</b>			200	<b>6.00</b> <b>1061271</b>
	250	<b>7.46</b>	<b>1061272</b>			250	<b>7.59</b> <b>1061273</b>
	300	<b>8.95</b>	<b>1061274</b>			300	<b>9.09</b> <b>1061275</b>
350	<b>10.41</b>	<b>1061276</b>			350	<b>10.55</b> <b>1061277</b>	
712		<i>Lokanais pievads ø8x12(1/2"x1/2")</i>					
	FF	<b>BEZ BLĪVĒM</b>			FM	<b>BEZ BLĪVĒM</b>	
	20	<b>1.72</b>	<b>1061691</b>			20	<b>1.76</b> <b>1061692</b>
	30	<b>1.89</b>	<b>1061693</b>			30	<b>1.92</b> <b>1061694</b>
	40	<b>2.03</b>	<b>1061695</b>			40	<b>2.06</b> <b>1061696</b>
	50	<b>2.15</b>	<b>1061697</b>			50	<b>2.19</b> <b>1061698</b>
	60	<b>2.29</b>	<b>1061699</b>			60	<b>2.33</b> <b>1061700</b>
	70	<b>2.46</b>	<b>1061701</b>			70	<b>2.49</b> <b>1061702</b>
	80	<b>2.66</b>	<b>1061703</b>			80	<b>2.70</b> <b>1061704</b>
	90	<b>2.89</b>	<b>1061705</b>			90	<b>2.93</b> <b>1061706</b>
	100	<b>3.06</b>	<b>1061707</b>			100	<b>3.09</b> <b>1061708</b>
	120	<b>3.53</b>	<b>1061709</b>			120	<b>3.55</b> <b>1061710</b>
	150	<b>4.22</b>	<b>1061711</b>			150	<b>4.24</b> <b>1061712</b>
	180	<b>4.85</b>	<b>1061713</b>			180	<b>4.89</b> <b>1061714</b>
	200	<b>5.06</b>	<b>1061715</b>			200	<b>5.08</b> <b>1061716</b>
	250	<b>6.20</b>	<b>1061717</b>			250	<b>6.22</b> <b>1061718</b>
	300	<b>7.41</b>	<b>1061719</b>			300	<b>7.43</b> <b>1061720</b>
350	<b>8.78</b>	<b>1061721</b>			350	<b>8.80</b> <b>1061722</b>	











		712/A		<i>Lokanais pievads</i> $\varnothing 8 \times 12(1/2" \times 1/2")$			
		FF	AR BLĪVĒM	FM	AR BLĪVĒM		
		20	<b>1.78</b>	1061550	20	<b>1.80</b>	1061551
		30	<b>1.90</b>	1061552	30	<b>1.94</b>	1061553
		40	<b>2.04</b>	1061554	40	<b>2.06</b>	1061555
		50	<b>2.15</b>	1061556	50	<b>2.17</b>	1061557
		60	<b>2.27</b>	1061558	60	<b>2.32</b>	1061559
		70	<b>2.42</b>	1061560	70	<b>2.45</b>	1061561
		80	<b>2.55</b>	1061562	80	<b>2.60</b>	1061563
		90	<b>2.72</b>	1061564	90	<b>2.74</b>	1061565
		100	<b>2.86</b>	1061566	100	<b>2.88</b>	1061567
		120	<b>3.14</b>	1061568	120	<b>3.17</b>	1061569
		150	<b>3.56</b>	1061570	150	<b>3.58</b>	1061571
		180	<b>3.98</b>	1061572	180	<b>4.03</b>	1061573
		200	<b>4.28</b>	1061574	200	<b>4.31</b>	1061575
		250	<b>5.01</b>	1061576	250	<b>5.04</b>	1061577
		300	<b>5.76</b>	1061578	300	<b>5.79</b>	1061579
350	<b>6.55</b>	1061580	350	<b>6.58</b>	1061581		
<b>708</b>		<i>Lokanais nerūsējošā tērauda pievads</i> $\varnothing 8 \times 12(3/8" \times 3/8")$					
		FF			FM		
		20	<b>2.24</b>	1061214	20	<b>2.22</b>	1061194
		30	<b>2.40</b>	1061215	30	<b>2.42</b>	1061208
		40	<b>2.62</b>	1061216	40	<b>2.61</b>	1061217
		50	<b>2.95</b>	1061193	50	<b>2.96</b>	1061218
		60	<b>3.45</b>	1061219	60	<b>3.39</b>	1061220
		70	<b>3.82</b>	1061221	70	<b>3.82</b>	1061222
		80	<b>4.21</b>	1061223	80	<b>4.22</b>	1061224
		90	<b>4.61</b>	1061225	90	<b>4.57</b>	1061226
		100	<b>4.96</b>	1061227	100	<b>4.96</b>	1061228
<b>707</b>		<i>Lokanais nerūsējošā tērauda pievads</i> $\varnothing 8 \times 12(F1/2" \times M3/8")$					
		FF			FM		
		30	<b>2.70</b>	1061131	30	<b>2.69</b>	1061183
		40	<b>2.93</b>	1061133	40	<b>2.93</b>	1061134
		50	<b>3.15</b>	1061135	50	<b>3.14</b>	1061136
		60	<b>3.36</b>	1061137	60	<b>3.36</b>	1061138
		70	<b>3.63</b>	1061139	70	<b>3.61</b>	1061140
		80	<b>3.85</b>	1061141	80	<b>3.85</b>	1061142
		90	<b>4.12</b>	1061143	90	<b>4.11</b>	1061144
		100	<b>4.34</b>	1061184	100	<b>4.33</b>	1061182
150	<b>5.44</b>	1061282	150	<b>5.44</b>	1061281		
<b>710</b>		<i>Lokanais nerūsējošā tērauda pievads</i>					
		<b>3/8"Fx<math>\varnothing 8</math></b>		<b>703</b>		<b>1/2"Fx<math>\varnothing 10</math></b>	
		20	<b>2.64</b>	1061229	20	<b>2.39</b>	1061086
		30	<b>2.85</b>	1061230	30	<b>2.67</b>	1061087
		40	<b>3.09</b>	1061210	40	<b>2.88</b>	1061088
		50	<b>3.34</b>	1061231	50	<b>3.12</b>	1061089
		60	<b>3.53</b>	1061232	60	<b>3.34</b>	1061090
		70	<b>3.78</b>	1061233	70	<b>3.62</b>	1061091
		80	<b>4.06</b>	1061234	80	<b>3.83</b>	1061092
		90	<b>4.28</b>	1061235	90	<b>4.09</b>	1061093
		100	<b>4.47</b>	1061236	100	<b>4.33</b>	1061094
<b>709</b>		<i>Lokanais nerūsējošā tērauda pievads ar līkumu</i> $\varnothing 9 \times 14 \times 1/2"$					
					30	<b>3.37</b>	1061195
					40	<b>3.58</b>	1061196
					50	<b>3.89</b>	1061197
					60	<b>4.07</b>	1061198
					70	<b>4.32</b>	1061201
					80	<b>4.51</b>	1061199
					90	<b>4.79</b>	1061211
					100	<b>5.01</b>	1061200
<b>719</b>		<i>Lokanais nerūsējošā tērauda pievads ar līkumu</i>					
		<b>713</b>		<b>713</b>		<b>713</b>	
		<b><math>\varnothing 9 \times 14(3/8" \times 3/8")</math></b>		<b><math>\varnothing 9 \times 14(1/2" \times 3/8")</math></b>		<b><math>\varnothing 9 \times 14(1/2" \times 3/8")</math></b>	
		30	<b>3.74</b>	1061510	30	<b>4.05</b>	1061287
		40	<b>3.91</b>	1061511	40	<b>4.20</b>	1061288
		50	<b>4.09</b>	1061512	50	<b>4.36</b>	1061285
		60	<b>4.29</b>	1061513	60	<b>4.55</b>	1061289
		70	<b>4.46</b>	1061514	70	<b>4.70</b>	1061286
		80	<b>4.65</b>	1061515	80	<b>4.89</b>	1061290
90	<b>4.83</b>	1061516	90	<b>5.05</b>	1061291		
100	<b>5.04</b>	1061517	100	<b>5.25</b>	1061292		

<b>704</b>	<i>Lokanie pievadi jaucējkrāniem, nerūsējošā tērauda Ø8x12(10Mx1/2")</i>				
		<b>LONG</b>		<b>SHORT</b>	
		Ø10x35 <b>2.37</b> 1061595		Ø10x35 <b>2.05</b> 1061065	
		Ø10x40 <b>2.55</b> 1061596		Ø10x40 <b>2.23</b> 1061179	
		Ø10x45 <b>2.67</b> 1061597		Ø10x45 <b>2.35</b> 1061180	
		Ø10x50 <b>2.75</b> 1061598		Ø10x50 <b>2.41</b> 1061066	
		Ø10x60 <b>3.04</b> 1061599		Ø10x60 <b>2.73</b> 1061181	
		Ø10x70 <b>3.31</b> 1061600		Ø10x70 <b>2.99</b> 1061067	
		Ø10x80 <b>3.49</b> 1061601		Ø10x80 <b>3.17</b> 1061068	
		Ø10x90 <b>3.81</b> 1061602		Ø10x90 <b>3.50</b> 1061069	
		Ø10x100 <b>4.01</b> 1061603		Ø10x100 <b>3.69</b> 1061070	
		Ø10x120 <b>4.56</b> 1061604		Ø10x120 <b>4.24</b> 1061073	
		Ø10x150 <b>5.44</b> 1061605		Ø10x150 <b>5.12</b> 1061074	
	<i>Lokanie pievadi jaucējkrāniem, nerūsējošā tērauda Ø8x12(12Mx1/2")</i>				
				Ø12x35 <b>2.26</b> 1061121	
				Ø12x50 <b>2.64</b> 1061122	
				Ø12x70 <b>3.12</b> 1061123	
				Ø12x80 <b>3.39</b> 1061124	
				Ø12x90 <b>3.59</b> 1061125	
				Ø12x100 <b>3.86</b> 1061126	
				Ø12x120 <b>4.18</b> 1061127	
				Ø12x150 <b>4.88</b> 1061128	
<b>704/G</b>	<i>Lokanie pievadi jaucējkrāniem, nerūsējošā tērauda Ø8x12(10Mx1/2") (90 mm)</i>				
				Ø10x35 <b>4.77</b> 1061172	
				Ø10x50 <b>5.65</b> 1061363	
<b>704/1</b>	<i>Lokanais pievadi jaucējkrāniem, nerūsējošā tērauda Ø8x12(10Mx3/8")</i>				
		Ø10x35 <b>2.62</b> 1061606		Ø10x35 <b>2.34</b> 1061185	
		Ø10x45 <b>3.26</b> 1061607		Ø10x45 <b>3.00</b> 1061360	
		Ø10x50 <b>3.20</b> 1061608		Ø10x50 <b>2.92</b> 1061171	
		Ø10x70 <b>3.95</b> 1061609		Ø10x70 <b>3.68</b> 1061293	
		Ø10x80 <b>4.05</b> 1061610		Ø10x80 <b>3.77</b> 1061209	
		Ø10x100 <b>4.43</b> 1061611		Ø10x100 <b>4.14</b> 1061280	
<b>724</b>	<i>Lokanie pievadi jaucējkrāniem, nerūsējošā tērauda Ø8x12(10Mx1/2")</i> <i>iekšējās caurules materiāls PEX-B</i>	<b>LONG</b>		<b>SHORT</b>	
		Ø10x35 <b>2.47</b> 1061653		Ø10x35 <b>2.13</b> 1061641	
		Ø10x40 <b>2.62</b> 1061654		Ø10x40 <b>2.30</b> 1061642	
		Ø10x45 <b>2.75</b> 1061655		Ø10x45 <b>2.43</b> 1061643	
		Ø10x50 <b>2.80</b> 1061656		Ø10x50 <b>2.51</b> 1061644	
		Ø10x60 <b>3.11</b> 1061657		Ø10x60 <b>2.80</b> 1061645	
		Ø10x70 <b>3.35</b> 1061658		Ø10x70 <b>3.04</b> 1061646	
		Ø10x80 <b>3.51</b> 1061659		Ø10x80 <b>3.21</b> 1061647	
		Ø10x90 <b>3.83</b> 1061660		Ø10x90 <b>3.52</b> 1064648	
		Ø10x100 <b>4.03</b> 1061661		Ø10x100 <b>3.72</b> 1061649	
		Ø10x120 <b>4.56</b> 1061662		Ø10x120 <b>4.24</b> 1061650	
		Ø10x150 <b>5.38</b> 1061663		Ø10x150 <b>5.08</b> 1061651	
<b>724/1</b>	<i>Lokanais pievadi jaucējkrāniem, nerūsējošā tērauda Ø8x12(10Mx3/8")</i> <i>iekšējās caurules materiāls PEX-B</i>	<b>LONG</b>		<b>SHORT</b>	
		Ø10x35 <b>3.07</b> 1061670		Ø10x35 <b>2.71</b> 1061664	
		Ø10x45 <b>3.23</b> 1061671		Ø10x45 <b>3.06</b> 1061665	
		Ø10x50 <b>3.52</b> 1061672		Ø10x50 <b>3.30</b> 1061666	
		Ø10x70 <b>4.26</b> 1061673		Ø10x70 <b>4.01</b> 1061667	
		Ø10x80 <b>4.32</b> 1061674		Ø10x80 <b>4.09</b> 1061668	
		Ø10x100		Ø10x100 <b>4.41</b> 1061669	
<b>724/G</b>	<i>Lokanie pievadi jaucējkrāniem, nerūsējošā tērauda Ø8x12(10Mx1/2") (90 mm)</i> <i>iekšējās caurules materiāls PEX-B</i>				
				Ø10x35 <b>4.80</b> 1061675	
				Ø10x50 <b>5.64</b> 1061676	

## VEIKALS

706		Lokanie nerūsējošā tērauda pievadi gāzei (1/2"x1/2")							
FF			FM						
	50	4.86	1061109				50	4.86	1061110
	80	5.48	1061111				80	5.48	1061112
	100	6.01	1061113				100	6.01	1061114
	120	6.68	1061115				120	6.68	1061116
	150	7.62	1061117				150	7.62	1061118
	200	9.18	1061119				200	9.18	1061120
714		Lokanais nerūsējošā tērauda pievads Ø13x18							
FF			FM						
	1/2"x200	3.89	1061400				1/2"x200	3.55	1061401
	1/2"x300	4.31	1061402				1/2"x300	3.96	1061403
	1/2"x400	4.72	1061404				1/2"x400	4.38	1061405
	1/2"x500	5.13	1061406				1/2"x500	4.79	1061407
	1/2"x600	5.54	1061408				1/2"x600	5.21	1061409
	1/2"x700	5.95	1061410				1/2"x700	5.62	1061411
	1/2"x800	6.37	1061412				1/2"x800	6.04	1061413
	1/2"x900	6.78	1061414				1/2"x900	6.46	1061415
	1/2"x1000	7.21	1061416				1/2"x1000	6.88	1061417
715		Lokanais nerūsējošā tērauda pievads Ø13x18							
FF			FM						
	3/4"x200	6.35	1061430				3/4"x200	5.96	1061431
	3/4"x300	6.77	1061432				3/4"x300	6.38	1061433
	3/4"x400	7.18	1061434				3/4"x400	6.80	1061435
	3/4"x500	7.61	1061436				3/4"x500	7.21	1061437
	3/4"x600	8.02	1061438				3/4"x600	7.63	1061439
	3/4"x700	8.44	1061440				3/4"x700	8.04	1061441
	3/4"x800	8.85	1061442				3/4"x800	8.46	1061443
	3/4"x900	9.27	1061444				3/4"x900	8.87	1061445
	3/4"x1000	9.68	1061446				3/4"x1000	9.29	1061447
716		Lokanais nerūsējošā tērauda pievads ar līkumu Ø13x18							
FF									
	1/2"x300	7.53	1061460						
	1/2"x400	7.94	1061461						
	1/2"x500	8.37	1061462						
	1/2"x600	8.78	1061463						
	1/2"x700	9.19	1061464						
	1/2"x800	9.61	1061465						
	1/2"x900	10.02	1061466						
	1/2"x1000	10.43	1061467						
	1/2"x1200	11.27	1061468						
	1/2"x1500	12.51	1061469						
717		Lokanais nerūsējošā tērauda pievads ar līkumu Ø13x18							
FF									
	3/4"x300	9.77	1061471						
	3/4"x400	10.20	1061472						
	3/4"x500	10.61	1061473						
	3/4"x600	11.03	1061474						
	3/4"x700	11.44	1061475						
	3/4"x800	11.86	1061476						
	3/4"x900	12.27	1061477						
	3/4"x1000	12.69	1061478						
	3/4"x1200	13.53	1061479						
	3/4"x1500	14.77	1061480						
718		Lokanais nerūsējošā tērauda pievads ar līkumu Ø13x18							
FF			FM						
	1/2" F x 3/4" F	1061492	9.48	1/2" M x 3/4" F	300	8.27	1061483		
	1/2" F x 3/4" F	1061493	9.94	1/2" M x 3/4" F	400	8.68	1061484		
	1/2" F x 3/4" F	1061494	10.41	1/2" M x 3/4" F	500	9.11	1061485		
	1/2" F x 3/4" F			1/2" M x 3/4" F	600	9.55	1061617		
	1/2" F x 3/4" F	1061731	11.37	1/2" M x 3/4" F	700	11.66	1061745		
	1/2" F x 3/4" F			1/2" M x 3/4" F	800	10.36	1061488		
	1/2" F x 3/4" F			1/2" M x 3/4" F	900				
	1/2" F x 3/4" F			1/2" M x 3/4" F	1000	11.17	1061688		

	<b>TF</b>					<i>Antivibrācijas lokanie pievadi</i>			
	3/4"x200	<b>4.68</b>	<b>1061095</b>	1"x300	<b>7.96</b>	<b>1061154</b>			
	3/4"x300	<b>5.22</b>	<b>1061096</b>	1"x400	<b>8.21</b>	<b>1061155</b>			
	3/4"x400	<b>5.77</b>	<b>1061097</b>	1"x500	<b>8.55</b>	<b>1061156</b>			
	3/4"x500	<b>6.32</b>	<b>1061098</b>	1"x600	<b>9.14</b>	<b>1061157</b>			
	3/4"x600	<b>6.88</b>	<b>1061099</b>	1"x700	<b>9.77</b>	<b>1061158</b>			
	3/4"x700	<b>7.44</b>	<b>1061100</b>	1"x800	<b>10.60</b>	<b>1061190</b>			
	3/4"x800	<b>8.00</b>	<b>1061101</b>	1"x900	<b>10.91</b>	<b>1061159</b>			
	3/4"x900	<b>8.56</b>	<b>1061102</b>	1"x1000	<b>11.77</b>	<b>1061160</b>			
	3/4"x1000	<b>9.19</b>	<b>1061103</b>	1"x1200	<b>15.70</b>	<b>1061245</b>			
	3/4"x1200	<b>13.24</b>	<b>1061243</b>	1"x1500	<b>18.04</b>	<b>1061240</b>			
	3/4"x1500	<b>15.31</b>	<b>1061241</b>						
	<b>TFF</b>					<i>Antivibrācijas lokanie pievadi</i>			
	3/4"x300	<b>6.20</b>	<b>1061542</b>	1"x300	<b>8.90</b>	<b>1061279</b>			
	3/4"x400	<b>6.52</b>	<b>1061212</b>	1"x400	<b>9.52</b>	<b>1061207</b>			
	3/4"x500	<b>7.07</b>	<b>1061173</b>	1"x500	<b>10.14</b>	<b>1061178</b>			
	3/4"x600	<b>7.63</b>	<b>1061206</b>	1"x600	<b>10.76</b>	<b>1061191</b>			
	3/4"x700	<b>8.20</b>	<b>1061174</b>	1"x700	<b>11.39</b>	<b>1061177</b>			
	3/4"x800	<b>8.76</b>	<b>1061205</b>	1"x800	<b>12.03</b>	<b>1061192</b>			
	3/4"x900	<b>9.34</b>	<b>1061634</b>	1"x900	<b>12.67</b>	<b>1061189</b>			
	3/4"x1000	<b>9.92</b>	<b>1061175</b>	1"x1000	<b>13.32</b>	<b>1061170</b>			
	3/4"x1200	<b>11.66</b>	<b>1061635</b>	1"x1200	<b>16.39</b>	<b>1061296</b>			
		<b>TFG</b>					<i>Antivibrācijas lokanie pievadi ar līkumu</i>		
3/4"x300		<b>6.77</b>	<b>1061147</b>	1"x300	<b>8.55</b>	<b>1061161</b>			
3/4"x400		<b>7.19</b>	<b>1061148</b>	1"x400	<b>9.03</b>	<b>1061162</b>			
3/4"x500		<b>7.58</b>	<b>1061149</b>	1"x500	<b>9.52</b>	<b>1061163</b>			
3/4"x600		<b>8.06</b>	<b>1061150</b>	1"x600	<b>9.89</b>	<b>1061164</b>			
3/4"x700		<b>8.55</b>	<b>1061151</b>	1"x700	<b>10.32</b>	<b>1061165</b>			
3/4"x800		<b>9.09</b>	<b>1061213</b>	1"x800	<b>10.83</b>	<b>1061202</b>			
3/4"x900		<b>9.60</b>	<b>1061152</b>	1"x900	<b>11.21</b>	<b>1061166</b>			
3/4"x1000		<b>9.92</b>	<b>1061153</b>	1"x1000	<b>11.58</b>	<b>1061167</b>			
				1"x1200	<b>17.21</b>	<b>1061297</b>			
		<b>TFFG</b>					<i>Antivibrācijas lokanie pievadi ar līkumu</i>		
	3/4"x500	<b>9.44</b>	<b>1061347</b>	1"x500	<b>13.36</b>	<b>1061238</b>			
	3/4"x600	<b>9.92</b>	<b>1061244</b>	1"x600	<b>13.89</b>	<b>1061298</b>			
	3/4"x700	<b>10.30</b>	<b>1061545</b>	1"x700	<b>14.42</b>	<b>1061239</b>			
	3/4"x800	<b>10.90</b>	<b>1061283</b>	1"x800	<b>16.58</b>	<b>1061547</b>			
	3/4"x900			1"x900	<b>17.40</b>	<b>1061734</b>			
	3/4"x1000	<b>11.90</b>	<b>1061294</b>	1"x1000	<b>18.12</b>	<b>1061540</b>			
		<b>TFN</b>					<i>Antivibrācijas lokanie pievadi, nerūsējošais tērauds</i>		
3/4"x200		<b>4.96</b>	<b>1061312</b>	1"x300	<b>8.03</b>	<b>1061145</b>			
3/4"x300		<b>5.67</b>	<b>1061313</b>	1"x400	<b>8.64</b>	<b>1061146</b>			
3/4"x400		<b>6.39</b>	<b>1061314</b>	1"x500	<b>9.26</b>	<b>1061176</b>			
3/4"x500		<b>7.12</b>	<b>1061315</b>	1"x600	<b>9.90</b>	<b>1061299</b>			
3/4"x600		<b>7.86</b>	<b>1061316</b>	1"x700	<b>10.53</b>	<b>1061300</b>			
3/4"x700		<b>8.61</b>	<b>1061317</b>	1"x800	<b>11.17</b>	<b>1061301</b>			
3/4"x800		<b>9.35</b>	<b>1061318</b>	1"x900	<b>11.81</b>	<b>1061302</b>			
3/4"x900		<b>10.12</b>	<b>1061319</b>	1"x1000	<b>12.47</b>	<b>1061129</b>			
3/4"x1000		<b>10.87</b>	<b>1061320</b>	1"x1200	<b>15.17</b>	<b>1061130</b>			
				1"x1500	<b>17.95</b>	<b>1061132</b>			
	<b>TFFN</b>					<i>Antivibrācijas lokanie pievadi, nerūsējošais tērauds</i>			
	3/4"x300	<b>6.42</b>	<b>1061331</b>	1"x300	<b>8.85</b>	<b>1061330</b>			
	3/4"x400	<b>7.14</b>	<b>1061333</b>	1"x400	<b>9.44</b>	<b>1061332</b>			
	3/4"x500	<b>7.87</b>	<b>1061335</b>	1"x500	<b>10.05</b>	<b>1061334</b>			
	3/4"x600	<b>8.62</b>	<b>1061337</b>	1"x600	<b>10.67</b>	<b>1061336</b>			
	3/4"x700	<b>9.37</b>	<b>1061339</b>	1"x700	<b>11.30</b>	<b>1061338</b>			
	3/4"x800	<b>10.13</b>	<b>1061341</b>	1"x800	<b>11.93</b>	<b>1061340</b>			
	3/4"x900	<b>10.89</b>	<b>1061343</b>	1"x900	<b>12.57</b>	<b>1061342</b>			
	3/4"x1000	<b>11.66</b>	<b>1061345</b>	1"x1000	<b>13.23</b>	<b>1061344</b>			
		<b>TFGN</b>					<i>Antivibrācijas lokanie pievadi ar līkumu (nerūsējošā tērauda)</i>		
3/4"x300		<b>11.10</b>	<b>1061321</b>	1"x300	<b>14.41</b>	<b>1061303</b>			
3/4"x400		<b>11.92</b>	<b>1061322</b>	1"x400	<b>15.12</b>	<b>1061304</b>			
3/4"x500		<b>12.75</b>	<b>1061323</b>	1"x500	<b>15.85</b>	<b>1061305</b>			
3/4"x600		<b>13.59</b>	<b>1061324</b>	1"x600	<b>16.56</b>	<b>1061306</b>			
3/4"x700		<b>14.43</b>	<b>1061325</b>	1"x700	<b>17.31</b>	<b>1061307</b>			
3/4"x800		<b>15.29</b>	<b>1061326</b>	1"x800	<b>18.04</b>	<b>1061308</b>			
3/4"x900		<b>16.15</b>	<b>1061327</b>	1"x900	<b>18.80</b>	<b>1061309</b>			
3/4"x1000		<b>17.01</b>	<b>1061328</b>	1"x1000	<b>19.54</b>	<b>1061310</b>			
3/4"x1200		<b>20.66</b>	<b>1061329</b>	1"x1200	<b>23.18</b>	<b>1061311</b>			

<p><b>TFFGN</b></p> 	<p><i>Antivibrācijas lokanie pievadi ar līkumu (nerūsējošā tērauda)</i></p> <table border="1"> <tr><td>3/4"x300</td><td><b>11.85</b></td><td><b>1061365</b></td><td>1"x300</td><td><b>15.08</b></td><td><b>1061374</b></td></tr> <tr><td>3/4"x400</td><td><b>12.70</b></td><td><b>1061366</b></td><td>1"x400</td><td><b>15.81</b></td><td><b>1061375</b></td></tr> <tr><td>3/4"x500</td><td><b>13.54</b></td><td><b>1061367</b></td><td>1"x500</td><td><b>16.53</b></td><td><b>1061376</b></td></tr> <tr><td>3/4"x600</td><td><b>14.38</b></td><td><b>1061368</b></td><td>1"x600</td><td><b>17.26</b></td><td><b>1061377</b></td></tr> <tr><td>3/4"x700</td><td><b>15.24</b></td><td><b>1061369</b></td><td>1"x700</td><td><b>18.00</b></td><td><b>1061378</b></td></tr> <tr><td>3/4"x800</td><td><b>16.10</b></td><td><b>1061370</b></td><td>1"x800</td><td><b>18.74</b></td><td><b>1061379</b></td></tr> <tr><td>3/4"x900</td><td><b>16.97</b></td><td><b>1061371</b></td><td>1"x900</td><td><b>19.49</b></td><td><b>1061380</b></td></tr> <tr><td>3/4"x1000</td><td><b>17.85</b></td><td><b>1061372</b></td><td>1"x1000</td><td><b>20.25</b></td><td><b>1061381</b></td></tr> <tr><td>3/4"x1200</td><td><b>21.60</b></td><td><b>1061373</b></td><td>1"x1200</td><td><b>23.97</b></td><td><b>1061382</b></td></tr> </table>	3/4"x300	<b>11.85</b>	<b>1061365</b>	1"x300	<b>15.08</b>	<b>1061374</b>	3/4"x400	<b>12.70</b>	<b>1061366</b>	1"x400	<b>15.81</b>	<b>1061375</b>	3/4"x500	<b>13.54</b>	<b>1061367</b>	1"x500	<b>16.53</b>	<b>1061376</b>	3/4"x600	<b>14.38</b>	<b>1061368</b>	1"x600	<b>17.26</b>	<b>1061377</b>	3/4"x700	<b>15.24</b>	<b>1061369</b>	1"x700	<b>18.00</b>	<b>1061378</b>	3/4"x800	<b>16.10</b>	<b>1061370</b>	1"x800	<b>18.74</b>	<b>1061379</b>	3/4"x900	<b>16.97</b>	<b>1061371</b>	1"x900	<b>19.49</b>	<b>1061380</b>	3/4"x1000	<b>17.85</b>	<b>1061372</b>	1"x1000	<b>20.25</b>	<b>1061381</b>	3/4"x1200	<b>21.60</b>	<b>1061373</b>	1"x1200	<b>23.97</b>	<b>1061382</b>
3/4"x300	<b>11.85</b>	<b>1061365</b>	1"x300	<b>15.08</b>	<b>1061374</b>																																																		
3/4"x400	<b>12.70</b>	<b>1061366</b>	1"x400	<b>15.81</b>	<b>1061375</b>																																																		
3/4"x500	<b>13.54</b>	<b>1061367</b>	1"x500	<b>16.53</b>	<b>1061376</b>																																																		
3/4"x600	<b>14.38</b>	<b>1061368</b>	1"x600	<b>17.26</b>	<b>1061377</b>																																																		
3/4"x700	<b>15.24</b>	<b>1061369</b>	1"x700	<b>18.00</b>	<b>1061378</b>																																																		
3/4"x800	<b>16.10</b>	<b>1061370</b>	1"x800	<b>18.74</b>	<b>1061379</b>																																																		
3/4"x900	<b>16.97</b>	<b>1061371</b>	1"x900	<b>19.49</b>	<b>1061380</b>																																																		
3/4"x1000	<b>17.85</b>	<b>1061372</b>	1"x1000	<b>20.25</b>	<b>1061381</b>																																																		
3/4"x1200	<b>21.60</b>	<b>1061373</b>	1"x1200	<b>23.97</b>	<b>1061382</b>																																																		
<p><b>341/A</b></p> 	<p><i>Ieplūdes pievadi veļas mašīnām (PVC)</i></p> <table border="1"> <tr><td>3/4"x150</td><td><b>3.06</b></td><td><b>1061104</b></td></tr> <tr><td>3/4"x200</td><td><b>3.76</b></td><td><b>1061105</b></td></tr> <tr><td>3/4"x250</td><td><b>4.31</b></td><td><b>1061106</b></td></tr> <tr><td>3/4"x300</td><td><b>4.99</b></td><td><b>1061107</b></td></tr> <tr><td>3/4"x400</td><td><b>6.35</b></td><td><b>1061108</b></td></tr> </table>	3/4"x150	<b>3.06</b>	<b>1061104</b>	3/4"x200	<b>3.76</b>	<b>1061105</b>	3/4"x250	<b>4.31</b>	<b>1061106</b>	3/4"x300	<b>4.99</b>	<b>1061107</b>	3/4"x400	<b>6.35</b>	<b>1061108</b>																																							
3/4"x150	<b>3.06</b>	<b>1061104</b>																																																					
3/4"x200	<b>3.76</b>	<b>1061105</b>																																																					
3/4"x250	<b>4.31</b>	<b>1061106</b>																																																					
3/4"x300	<b>4.99</b>	<b>1061107</b>																																																					
3/4"x400	<b>6.35</b>	<b>1061108</b>																																																					
<p><b>341</b></p> 	<p><i>Ieplūdes pievadi veļas mašīnām ar līkumu (PVC)</i></p> <table border="1"> <tr><td>3/4"x100</td><td><b>2.87</b></td><td><b>1061295</b></td></tr> <tr><td>3/4"x150</td><td><b>3.12</b></td><td><b>1061080</b></td></tr> <tr><td>3/4"x200</td><td><b>3.78</b></td><td><b>1061081</b></td></tr> <tr><td>3/4"x250</td><td><b>4.35</b></td><td><b>1061082</b></td></tr> <tr><td>3/4"x300</td><td><b>5.04</b></td><td><b>1061083</b></td></tr> <tr><td>3/4"x400</td><td><b>6.43</b></td><td><b>1061084</b></td></tr> <tr><td>3/4"x500</td><td><b>8.47</b></td><td><b>1061186</b></td></tr> </table>	3/4"x100	<b>2.87</b>	<b>1061295</b>	3/4"x150	<b>3.12</b>	<b>1061080</b>	3/4"x200	<b>3.78</b>	<b>1061081</b>	3/4"x250	<b>4.35</b>	<b>1061082</b>	3/4"x300	<b>5.04</b>	<b>1061083</b>	3/4"x400	<b>6.43</b>	<b>1061084</b>	3/4"x500	<b>8.47</b>	<b>1061186</b>																																	
3/4"x100	<b>2.87</b>	<b>1061295</b>																																																					
3/4"x150	<b>3.12</b>	<b>1061080</b>																																																					
3/4"x200	<b>3.78</b>	<b>1061081</b>																																																					
3/4"x250	<b>4.35</b>	<b>1061082</b>																																																					
3/4"x300	<b>5.04</b>	<b>1061083</b>																																																					
3/4"x400	<b>6.43</b>	<b>1061084</b>																																																					
3/4"x500	<b>8.47</b>	<b>1061186</b>																																																					
<p><b>342</b></p> 	<p><i>Noplūdes pievadi veļas mašīnām</i></p> <table border="1"> <tr><td>150</td><td><b>1.83</b></td><td><b>1061075</b></td></tr> <tr><td>200</td><td><b>2.17</b></td><td><b>1061076</b></td></tr> <tr><td>250</td><td><b>2.53</b></td><td><b>1061077</b></td></tr> <tr><td>300</td><td><b>2.92</b></td><td><b>1061078</b></td></tr> <tr><td>400</td><td><b>3.85</b></td><td><b>1061187</b></td></tr> <tr><td>500</td><td><b>4.50</b></td><td><b>1061188</b></td></tr> </table>	150	<b>1.83</b>	<b>1061075</b>	200	<b>2.17</b>	<b>1061076</b>	250	<b>2.53</b>	<b>1061077</b>	300	<b>2.92</b>	<b>1061078</b>	400	<b>3.85</b>	<b>1061187</b>	500	<b>4.50</b>	<b>1061188</b>																																				
150	<b>1.83</b>	<b>1061075</b>																																																					
200	<b>2.17</b>	<b>1061076</b>																																																					
250	<b>2.53</b>	<b>1061077</b>																																																					
300	<b>2.92</b>	<b>1061078</b>																																																					
400	<b>3.85</b>	<b>1061187</b>																																																					
500	<b>4.50</b>	<b>1061188</b>																																																					
<p><b>704/SM</b></p> 	<p><i>Lokanais pievads virtuves krānam ar izvelkamu dušu 10x3/8" (smalkā vītne)</i></p> <table border="1"> <tr><td>15</td><td><b>3.90</b></td><td><b>1061362</b></td></tr> </table>	15	<b>3.90</b>	<b>1061362</b>																																																			
15	<b>3.90</b>	<b>1061362</b>																																																					
<p><b>339</b></p> 	<p><i>Štucēris, divpusējs</i></p> <table border="1"> <tr><td>20x20</td><td><b>0.37</b></td><td><b>3936322</b></td></tr> <tr><td>24x24</td><td><b>0.37</b></td><td><b>3936321</b></td></tr> </table>	20x20	<b>0.37</b>	<b>3936322</b>	24x24	<b>0.37</b>	<b>3936321</b>																																																
20x20	<b>0.37</b>	<b>3936322</b>																																																					
24x24	<b>0.37</b>	<b>3936321</b>																																																					
<p><b>700/K</b></p> 	<p><i>Pagarinātāju komplekts jaucējkrānu pievadiem Ø10</i></p> <table border="1"> <tr><td>88mm</td><td><b>3.82</b></td><td><b>7125001</b></td></tr> </table>	88mm	<b>3.82</b>	<b>7125001</b>																																																			
88mm	<b>3.82</b>	<b>7125001</b>																																																					
<p><b>705</b></p> 	<p><i>Lokanie pievadi, hromēti D13x1/2</i></p> <table border="1"> <tr><td>30 FF</td><td><b>2.00</b></td><td><b>0161005</b></td></tr> <tr><td>30 FM</td><td><b>2.59</b></td><td><b>0161001</b></td></tr> <tr><td>40 FM</td><td><b>2.98</b></td><td><b>0161002</b></td></tr> <tr><td>50 FM</td><td><b>3.36</b></td><td><b>0161003</b></td></tr> <tr><td>60 FM</td><td><b>3.83</b></td><td><b>0161004</b></td></tr> </table>	30 FF	<b>2.00</b>	<b>0161005</b>	30 FM	<b>2.59</b>	<b>0161001</b>	40 FM	<b>2.98</b>	<b>0161002</b>	50 FM	<b>3.36</b>	<b>0161003</b>	60 FM	<b>3.83</b>	<b>0161004</b>																																							
30 FF	<b>2.00</b>	<b>0161005</b>																																																					
30 FM	<b>2.59</b>	<b>0161001</b>																																																					
40 FM	<b>2.98</b>	<b>0161002</b>																																																					
50 FM	<b>3.36</b>	<b>0161003</b>																																																					
60 FM	<b>3.83</b>	<b>0161004</b>																																																					
<p><b>700/A</b></p> 	<p><i>Pievads izlietnes krānam</i></p> <table border="1"> <tr><td>35 cm</td><td><b>4.75</b></td><td><b>2010001</b></td></tr> <tr><td>50 cm</td><td><b>7.15</b></td><td><b>2010002</b></td></tr> </table>	35 cm	<b>4.75</b>	<b>2010001</b>	50 cm	<b>7.15</b>	<b>2010002</b>																																																
35 cm	<b>4.75</b>	<b>2010001</b>																																																					
50 cm	<b>7.15</b>	<b>2010002</b>																																																					
<p><b>706/DZ</b></p> 	<p><i>Pievads gāzei EN14800</i></p> <table border="1"> <thead> <tr> <th></th> <th>FF</th> <th></th> <th>FM</th> <th></th> <th></th> </tr> </thead> <tbody> <tr><td>500</td><td><b>11.13</b></td><td><b>1061520</b></td><td>500</td><td><b>11.13</b></td><td><b>1061526</b></td></tr> <tr><td>750</td><td><b>13.53</b></td><td><b>1061521</b></td><td>750</td><td><b>13.52</b></td><td><b>1061527</b></td></tr> <tr><td>1000</td><td><b>15.69</b></td><td><b>1061522</b></td><td>1000</td><td><b>15.69</b></td><td><b>1061528</b></td></tr> <tr><td>1250</td><td><b>17.20</b></td><td><b>1061523</b></td><td>1250</td><td><b>17.20</b></td><td><b>1061529</b></td></tr> <tr><td>1500</td><td><b>19.33</b></td><td><b>1061524</b></td><td>1500</td><td><b>19.44</b></td><td><b>1061530</b></td></tr> <tr><td>2000</td><td><b>26.34</b></td><td><b>1061525</b></td><td>2000</td><td><b>26.34</b></td><td><b>1061531</b></td></tr> </tbody> </table>		FF		FM			500	<b>11.13</b>	<b>1061520</b>	500	<b>11.13</b>	<b>1061526</b>	750	<b>13.53</b>	<b>1061521</b>	750	<b>13.52</b>	<b>1061527</b>	1000	<b>15.69</b>	<b>1061522</b>	1000	<b>15.69</b>	<b>1061528</b>	1250	<b>17.20</b>	<b>1061523</b>	1250	<b>17.20</b>	<b>1061529</b>	1500	<b>19.33</b>	<b>1061524</b>	1500	<b>19.44</b>	<b>1061530</b>	2000	<b>26.34</b>	<b>1061525</b>	2000	<b>26.34</b>	<b>1061531</b>												
	FF		FM																																																				
500	<b>11.13</b>	<b>1061520</b>	500	<b>11.13</b>	<b>1061526</b>																																																		
750	<b>13.53</b>	<b>1061521</b>	750	<b>13.52</b>	<b>1061527</b>																																																		
1000	<b>15.69</b>	<b>1061522</b>	1000	<b>15.69</b>	<b>1061528</b>																																																		
1250	<b>17.20</b>	<b>1061523</b>	1250	<b>17.20</b>	<b>1061529</b>																																																		
1500	<b>19.33</b>	<b>1061524</b>	1500	<b>19.44</b>	<b>1061530</b>																																																		
2000	<b>26.34</b>	<b>1061525</b>	2000	<b>26.34</b>	<b>1061531</b>																																																		
<p><b>706/DZ 90</b></p> 	<p><i>Pievads gāzei EN 14800</i></p> <table border="1"> <tr><td>500</td><td><b>15.34</b></td><td><b>1061532</b></td></tr> <tr><td>750</td><td><b>16.44</b></td><td><b>1061533</b></td></tr> <tr><td>1000</td><td><b>20.81</b></td><td><b>1061534</b></td></tr> <tr><td>1250</td><td><b>23.82</b></td><td><b>1061535</b></td></tr> <tr><td>1500</td><td><b>27.98</b></td><td><b>1061536</b></td></tr> <tr><td>2000</td><td><b>27.11</b></td><td><b>1061537</b></td></tr> </table>	500	<b>15.34</b>	<b>1061532</b>	750	<b>16.44</b>	<b>1061533</b>	1000	<b>20.81</b>	<b>1061534</b>	1250	<b>23.82</b>	<b>1061535</b>	1500	<b>27.98</b>	<b>1061536</b>	2000	<b>27.11</b>	<b>1061537</b>																																				
500	<b>15.34</b>	<b>1061532</b>																																																					
750	<b>16.44</b>	<b>1061533</b>																																																					
1000	<b>20.81</b>	<b>1061534</b>																																																					
1250	<b>23.82</b>	<b>1061535</b>																																																					
1500	<b>27.98</b>	<b>1061536</b>																																																					
2000	<b>27.11</b>	<b>1061537</b>																																																					

## VEIKALS







## VEIKALS

 <p><b>FX11102</b> Dušas klausule 1 režīmi (8*10 cm) HROMĒTA <b>9.70</b> 4839035</p> <p><i>Fiksēts ūdens plūsmas režīms</i></p>	<p>Klausule krānam uz vannas malas <b>FX11113</b> (12.5*7 cm) BALTS/HROMS <b>9.72</b> 4839002</p> <p><b>Iepakojums: maisiņš</b></p>
 <p><b>FX11104</b> Dušas klausule 1 režīmi (3.6*8.5 cm) HROMĒTA <b>8.50</b> 4839036</p> <p><i>Fiksēts ūdens plūsmas režīms</i></p>	
 <p><b>FX11105</b> Dušas klausule 1 režīmi Ø10.5 cm BALTS/HROMS <b>9.99</b> 4839037</p> <p><i>Fiksēts ūdens plūsmas režīms</i></p>	<p><b>FX12202</b> Dušas klausule Ø6.5 cm HROMĒTA <b>2.39</b> 4839011</p> <p><b>FX2033</b> Ø6.5 cm (bez blistera) HROMĒTA <b>3.96</b> 1139002</p> <p>Vecais kods: FX12033</p>
 <p><b>FX11106</b> Dušas klausule 1 režīmi Ø10 cm HROMĒTA <b>11.62</b> 4839040</p> <p><i>Šīs dušas izbūve nodrošina ūdens sajaukšanu ar gaisu, kā rezultātā patērētais ūdens daudzums tiek ietaupīts līdz 30%.</i></p>	<p><b>FX12204</b> Dušas klausule Ø8 cm HROMĒTA <b>4.35</b> 4839017</p>
 <p><b>FX31103</b> Dušas klausule 3 režīmi (12*12 cm) BALTS/HROMS <b>17.90</b> 4839038</p> <p><i>Tai skaitā kaskādes režīms. Režīmi tiek pārslēgti ar ergonomisku pogu.</i></p>	<p><b>FX51154</b> Dušas klausule 3 režīmi Ø9.5 cm HROMĒTA <b>7.26</b> 4839025</p>
 <p><b>FX31104</b> Dušas klausule 3 režīmi Ø10 cm HROMĒTA <b>12.39</b> 4839039</p> <p><i>Šīs dušas izbūve nodrošina ūdens sajaukšanu ar gaisu, kā rezultātā patērētais ūdens daudzums tiek ietaupīts līdz 30%.</i></p>	<p><b>FX32132</b> Dušas klausule 2 režīmi Ø8 cm HROMĒTA <b>4.50</b> 4839010</p>
 <p><b>FX31102</b> Dušas klausule 3 režīmi Ø12 cm HROMĒTA <b>12.08</b> 4839034</p>	<p><b>FX32233</b> Dušas klausule 3 režīmi Ø9.5 cm HROMĒTA <b>5.69</b> 4839021</p>









VEIKALS



VEIKALS

	<b>FX51153</b>	<i>Dušas klausule 5 režīmi</i> Ø7.5 cm HROMĒTA	<b>6.31</b>	<b>4839001</b>
Vecais kods: 51573				
	<b>FX11205</b>	<i>Klausule virtuves izlietnes krānam</i> Ø4.8 cm HROMĒTA	<b>6.89</b>	<b>4839007</b>
Vecais kods: FX1127				
	<b>FX11101</b>	<i>Klausule bidē krānam</i> Ø3 cm HROMĒTA	<b>4.45</b>	<b>4839015</b>
Vecais kods: FX18107				
	<b>FX11108</b>	<i>Dušas klausule</i> Ø10 cm BALTS/HROMS	<b>7.99</b>	<b>4839028</b>
	<b>FX11309</b>	<i>Dušas klausule</i> (6.5*4.0 cm) HROMĒTA	<b>6.25</b>	<b>4839029</b>
	<b>FX11114</b>	<i>Dušas galva</i> Diametrs 200 mm HROMĒTA	<b>20.88</b>	<b>4839024</b>
	<b>FX1546</b>	<i>Dušas galva</i> Diametrs 80 mm HROMĒTA	<b>6.02</b>	<b>4839018</b>
Vecais kods: FX1695				
	<b>FX11200</b>	<i>Dušas galva</i> Diametrs 100 mm HROMĒTA	<b>6.32</b>	<b>4839045</b>

	<b>FX11201</b>	<i>Dušas galva</i> Diametrs 100 mm HROMĒTA	<b>6.90</b>	<b>4839046</b>
	<b>FX12202+108</b>	<i>Dušas kalusule ar pievadu</i> Iepakojums blisteris	<b>6.23</b>	<b>4830009</b>
Rokas duša D6.5 cm Dušas pievads 150 cm				
	<b>FX2033+10815</b>	<i>Dušas kalusule ar pievadu un turētāju</i> Iepakojums, kartona blisteris	<b>3.60</b>	<b>4830011</b>
Rokas duša D6.5 cm Dušas pievads 150 cm Stiprinājums FL15 (plastmasa)				
	<b>FX94000</b>	<i>Kronšteins dušas galvai</i> Misiņa	<b>17.02</b>	<b>4839042</b>
15 cm				
	<b>FX2580</b>	<i>Dušas kronšteins</i> Plastmasa HROMĒTA	<b>4.05</b>	<b>4839003</b>
	<b>FL15</b>	<i>Dušas kronšteins</i> bez iepakojuma Plastmasa HROMĒTA	<b>1.56</b>	<b>7139000</b>
	<b>FX2582</b>	<i>Dušas kronšteins (plastmasa)</i>	<b>2.95</b>	<b>4839005</b>
	<b>FX2583</b>	<i>Dušas kronšteins (metāla)</i>	<b>17.02</b>	<b>4839023</b>
	<b>FX2584</b>	<i>Dušas kronšteins</i> Plastmasa HROMĒTA	<b>2.39</b>	<b>4839022</b>



## VEIKALS

	<i>Dušas pievads, sudrabots PVC</i> <b>105-MG</b> 170 cm <b>11.25</b> <b>4810009</b> <i>HROMĒTS</i>
	<i>Dubultā pinuma dušas pievads</i> <b>106-MG</b> 80 cm <b>5.60</b> <b>4810017</b> 150 cm <b>6.55</b> <b>4810001</b> 200 cm <b>7.79</b> <b>4810002</b> <i>HROMĒTS</i>
	<i>Dušas pievads</i> <b>108-MG</b> 150 cm <b>3.60</b> <b>4810011</b> 200 cm <b>4.47</b> <b>4810012</b> <i>HROMĒTS</i>
	<i>Dušas pievads, elastīgais</i> <b>109-MG</b> 150 cm <b>9.10</b> <b>4810010</b> <i>170-220 cm</i> <i>HROMĒTS</i>
	<i>Dušas pievads Anti-Twist</i> <b>111-MG</b> 150 cm <b>7.32</b> <b>4810006</b> <i>HROMĒTS</i>
	<i>Dušas pievads jaucējkrānam MG2059</i> <b>RMG2059</b> 50 cm <b>9.18</b> <b>7110042</b> <i>Neilona pinums</i>
	<i>Dušas stienis komplektā</i> <b>FX31104+255</b> <b>36.45</b> <b>4830015</b> <i>3 režīmi</i> <i>HROMĒTS</i> Rokas duša Ø10 cm Dušas pievads 150 cm Stienis pa centriem 52 cm

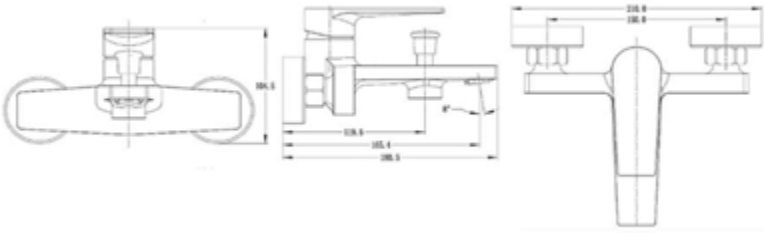

	<i>Dušas stienis komplektā</i> <b>FX31105+259</b> <b>49.44</b> <b>4830020</b> <i>melns</i> Rokas duša Ø11.5 cm Dušas pievads 150 cm Stienis pa centriem 55 cm
	<i>Dušas stienis komplektā</i> <b>FX32233+252</b> <b>24.04</b> <b>4830003</b> <i>HROMĒTS</i> Rokas duša Ø9.5 cm Dušas pievads 150 cm Stienis pa centriem 52 cm Vecais kods: 2017+252
	<i>Dušas stienis komplektā</i> <b>FX12202+253</b> <b>18.81</b> <b>4830004</b> <i>HROMĒTS</i> Rokas duša Ø6.5 cm Dušas pievads 150 cm Stienis pa centriem 54 cm Vana kods: 2033+253
	<i>Dušas stienis 18 mm</i> <b>FX253</b> <b>11.02</b> <b>4830006</b> <i>HROMĒTS</i> Stienis pa centriem 54 cm
	<i>Dušas stienis 22 mm</i> <b>FX254</b> <b>17.99</b> <b>4830013</b> <i>HROMĒTS</i> Stienis pa centriem 60 cm

**VEIKALS**



**FS1126-2** *Vannas krāns bez komplekta*  
**89.96** **1102004**

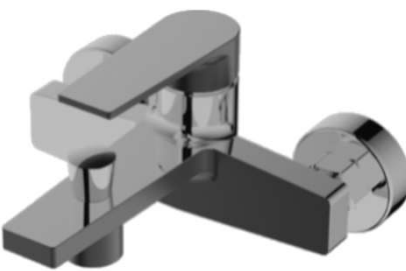
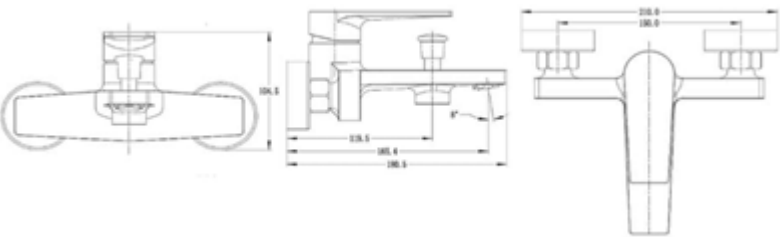





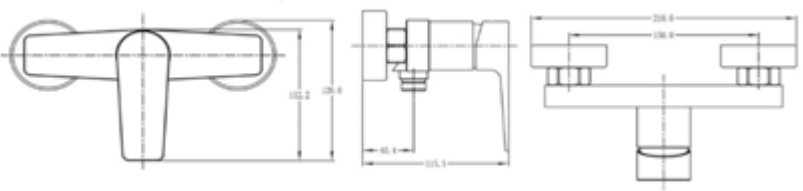



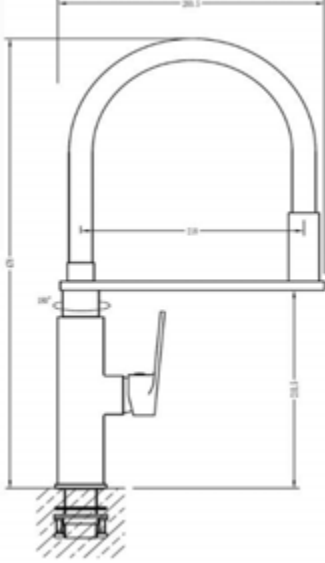

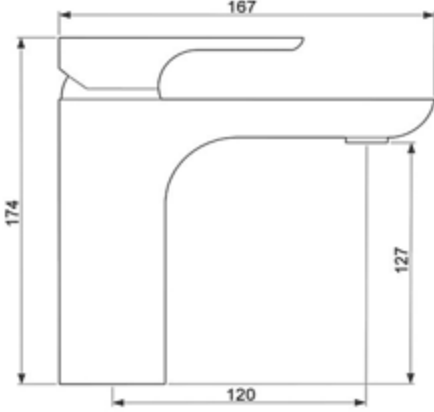

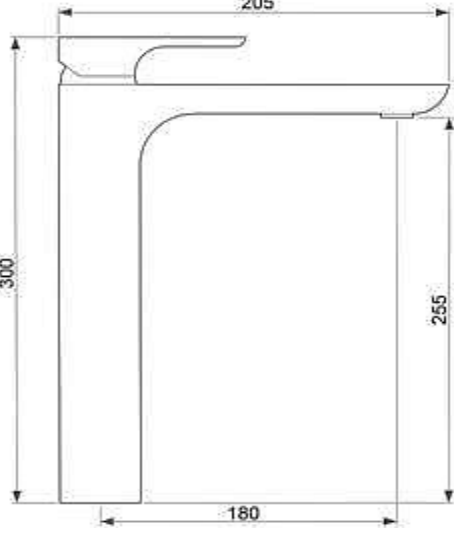

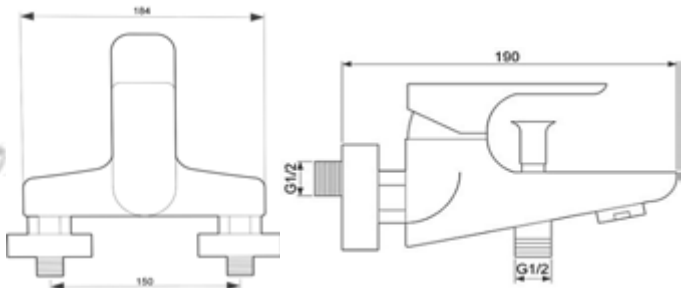

**FS1127-2** *Vannas krāns bez komplekta*  
**89.96** **1102075**

**FS1127-4** *Dušas krāns bez komplekta*  
**63.11** **1102076**

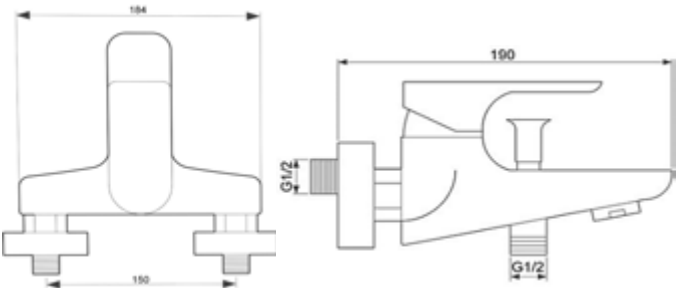
	<p><b>MG-2359</b></p> 	<p><i>Virtuves izlietnes krāns ar lokanu izteku</i></p> <p><b>137.71</b></p> <p><b>7102188</b></p> <p>35 mm</p> 
	<p><b>MG - 2360</b></p> 	<p><i>Keramiskās izlietnes krāns</i></p> <p><b>77.10</b></p> <p><b>7102102</b></p> <p>35 mm</p> 
	<p><b>MG - 2362</b></p> 	<p><i>Keramiskās izlietnes krāns, augstais</i></p> <p><b>121.12</b></p> <p><b>7102103</b></p> <p>35 mm</p> 

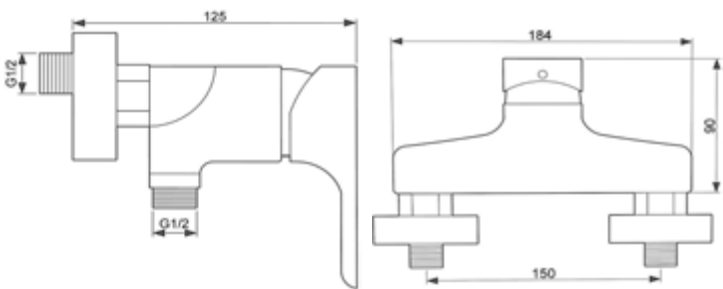
<p style="text-align: center;"><b>MG - 2320</b></p> 	<p style="text-align: right;"><i>Vannas krāns, bez komplekta</i></p> <p style="text-align: center;"><b>106.22</b></p> <p style="text-align: right;"><b>7102104</b></p> 	<p style="text-align: right;">35 mm</p> 
	<p style="text-align: center;"><b>MG - 2321</b></p> <p style="text-align: right;"><i>Vannas krāns ar komplektu</i></p> <p style="text-align: center;"><b>122.20</b></p> <p style="text-align: right;"><b>7102105</b></p> 	<p style="text-align: right;">35 mm</p> 
	<p style="text-align: center;"><b>MG - 2340</b></p> <p style="text-align: right;"><i>Dušas krāns bez komplekta</i></p> <p style="text-align: center;"><b>76.64</b></p> <p style="text-align: right;"><b>7102106</b></p> 	<p style="text-align: right;">35 mm</p> 
	<p style="text-align: center;"><b>MG - 2341</b></p> <p style="text-align: right;"><i>Dušas krāns ar komplektu</i></p> <p style="text-align: center;"><b>83.31</b></p> <p style="text-align: right;"><b>7102107</b></p> 	<p style="text-align: right;">35 mm</p> 

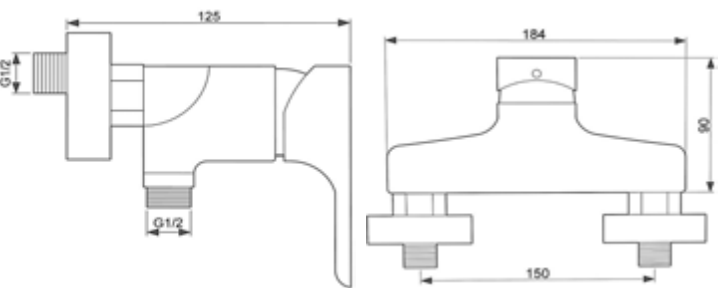

VEIKALS

MG - 2220

EUR

Vannas krāns ar termostatu



103.02

7105001

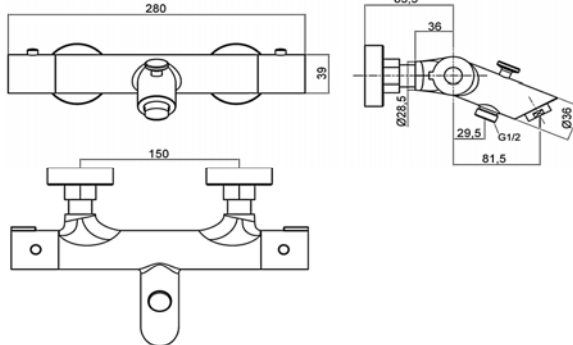

MG - 2240

Dušas krāns ar termostatu



92.31

7105002

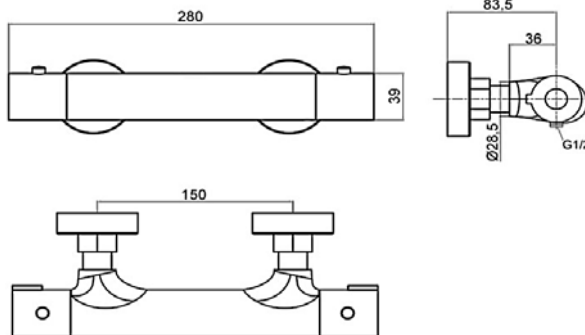

MG-2290

Dušas krāns ar dušas stieni

201.91

7105003

MG-2292

Dušas krāns ar dušas stieni (neuzkarstošs korpuss)

256.40

7105006

MG-2295









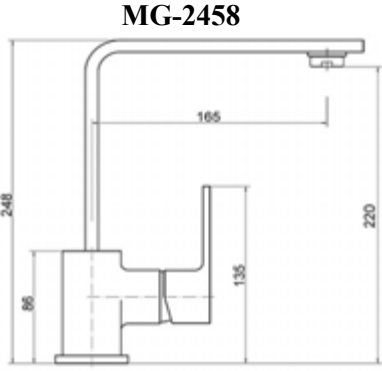

Dušas krāns (ar izteku), ar dušas stieni

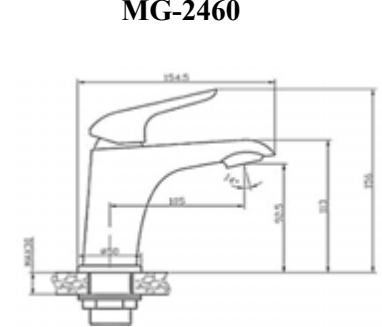
244.77

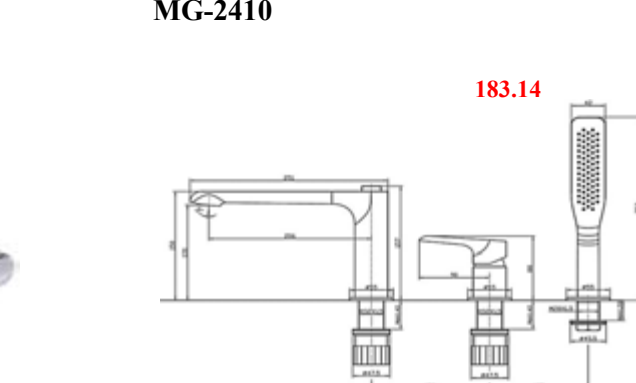
7105004

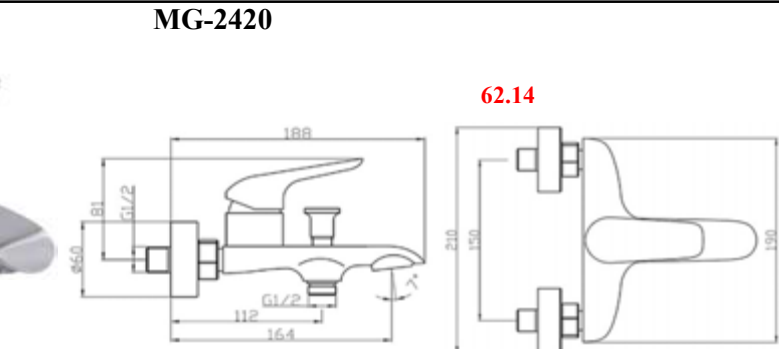

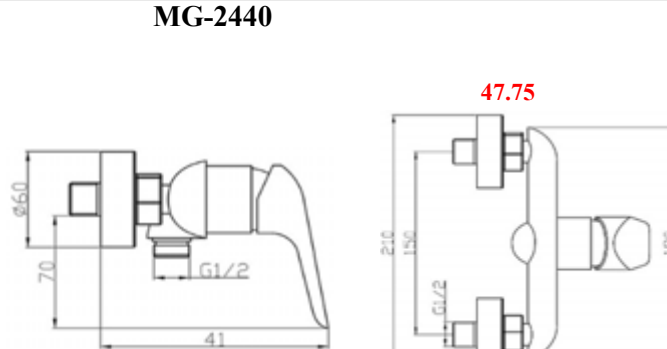





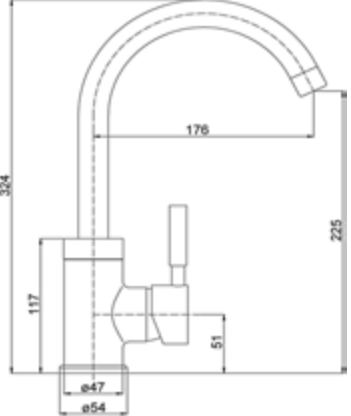

VEIKALS

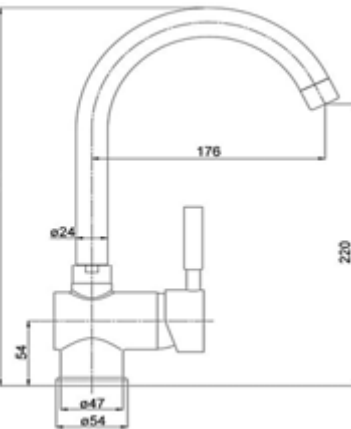
	<p><b>MG-2458</b></p> 	<p><b>EUR</b> <b>70.74</b></p>	<p><i>Keramiskās izlietnes krāns</i> <b>7102157</b></p>	<p>35 mm</p> 
	<p><b>MG-2460</b></p> 	<p><b>58.32</b> <b>58.32</b></p>	<p><i>Keramiskās izlietnes krāns</i> COLD START <b>7102061</b> <b>7102201</b></p>	<p>35 mm</p> 
	<p><b>MG-2410</b></p> 	<p><b>183.14</b></p>	<p><i>Krāns uz vannas malas</i> <b>7102062</b></p>	<p>35 mm</p> 
	<p><b>MG-2420</b></p> 	<p><b>62.14</b></p>	<p><i>Vannas krāns</i> <b>7102172</b></p>	<p>35 mm</p> 
	<p><b>MG-2440</b></p> 	<p><b>47.75</b></p>	<p><i>Dušas kabīnes krāns</i> <b>7102171</b></p>	<p>35 mm</p> 

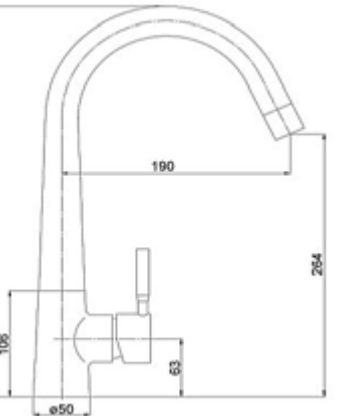

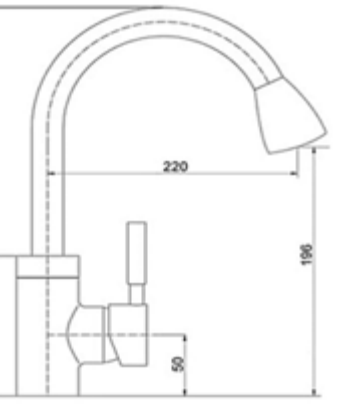





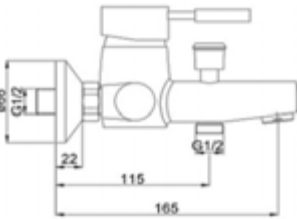
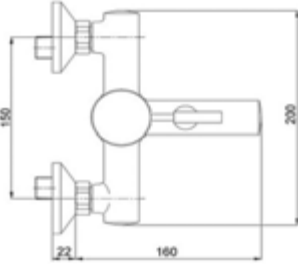

## VEIKALS

	<p><b>MG - 2055</b></p> 	<p><b>EUR</b></p> <p><b>52.78</b></p>	<p><i>Virtuves izlietnes krāns</i></p> <p><b>7103190</b></p> <p>40 mm</p> 
	<p><b>MG - 2054</b></p> 	<p><b>53.50</b></p>	<p><i>Virtuves izlietnes krāns</i></p> <p><b>7103189</b></p> <p>40 mm</p> 
	<p><b>MG - 2053</b></p> 	<p><b>70.86</b></p>	<p><i>Virtuves izlietnes krāns</i></p> <p><b>7102161</b></p> <p>35 mm</p> 
	<p><b>MG-2056</b></p> 	<p><b>89.61</b></p>	<p><i>Virtuves izlietnes krāns ar izvelkamu dušu</i></p> <p><b>7103203</b></p> <p>35 mm</p> 

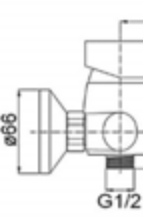
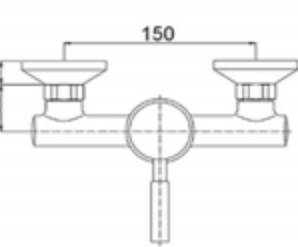
VEIKALS

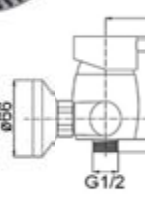
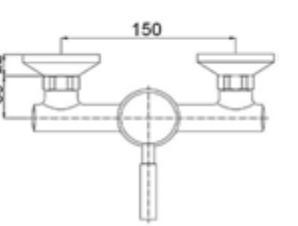
	<p><b>MG-2057</b></p>	<p><i>Virtuves izlietnes krāns ar izvelkamu izteku</i></p>	<p><b>76.53</b></p>	<p><b>7103204</b></p>
	<p>35 mm</p>			
	<p><b>MG - 2058</b></p>	<p><i>Virtuves izlietnes krāns ar izvadu filtrētām ūdenim</i></p>	<p><b>77.00</b></p>	<p><b>7102193</b></p>
	<p>35 mm</p>			
	<p><b>MG - 2060</b></p>	<p><i>Keramiskās izlietnes krāns</i></p>	<p><b>65.51</b></p>	<p><b>7103191</b></p>
	<p>40 mm</p>			

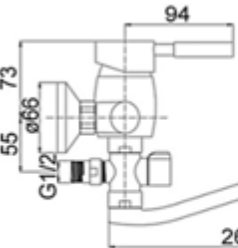
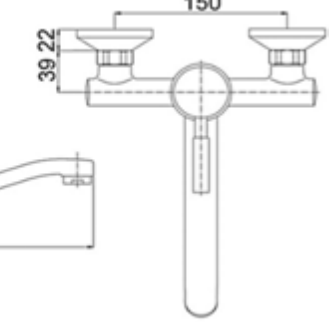
VEIKALS

	<p>MG-2020</p>	<p>Vannas krāns</p>
	<p>51.72</p>	<p>7103201 40 mm</p>
		
		
	<p>MG - 2040</p>	<p>Dušas kabīnes krāns</p>
	<p>39.04</p>	<p>7103192 40 mm</p>
		
		
	<p>MG - 2041</p>	<p>Dušas kabīnes krāns komplektā</p>
	<p>45.67</p>	<p>7103093 40 mm</p>
		
		
	<p>MG - 2036</p>	<p>Vannas krāns</p>
	<p>62.18</p>	<p>7103193 40 mm</p>
		
		

VEIKALS

EUR

Virtuves izlietnes krāns

53.63

7102073

35 mm

**JAUNUMS**

MG - 1954

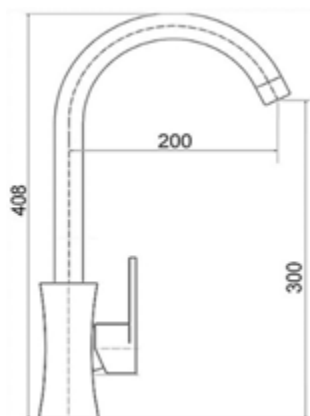

Virtuves izlietnes krāns

MG-1955

70.74

7102156

35 mm

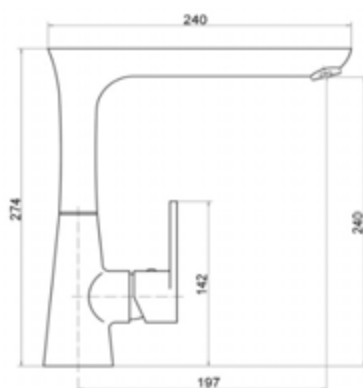

Keramiskās izlietnes krāns

MG - 1960

45.69

7102158

35 mm

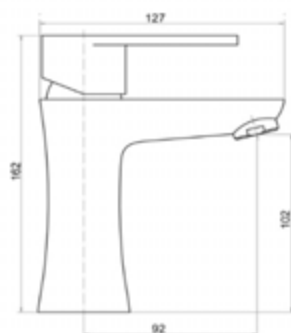

Keramiskās izlietnes krāns







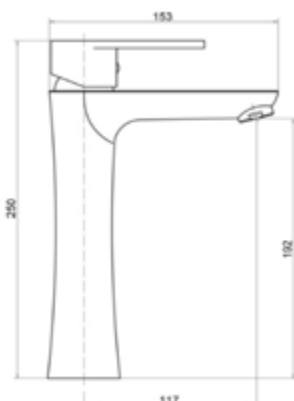

MG - 1962

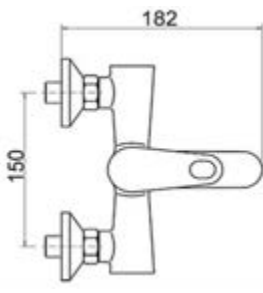
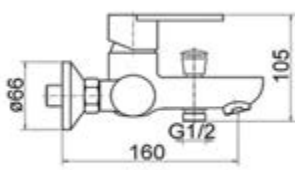
59.30

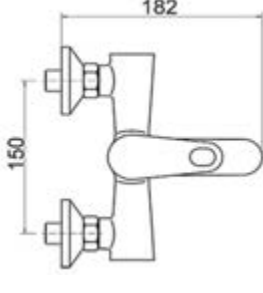
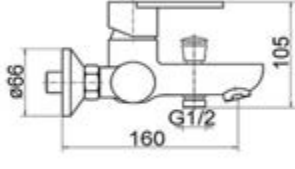
7102159

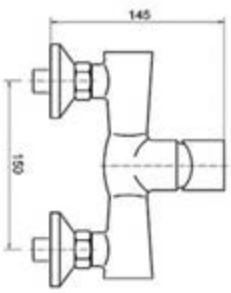
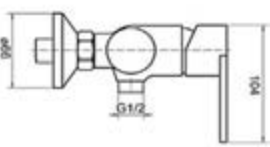
35 mm

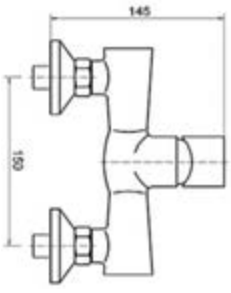
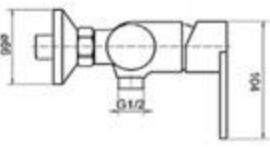

	<p><b>MG - 1920</b></p> 	<p><b>57.66</b></p> 	<p><i>Vannas krāns</i></p> <p><b>7102153</b> 35 mm</p> 
	<p><b>MG - 1921</b></p> 	<p><b>66.86</b></p> 	<p><i>Vannas krāns</i></p> <p><b>7102164</b> 35 mm</p> 
	<p><b>MG - 1940</b></p> 	<p><b>43.06</b></p> 	<p><i>Duļas kabīnes krāns</i></p> <p><b>7102155</b> 35 mm</p> 
	<p><b>MG - 1941</b></p> 	<p><b>51.76</b></p> 	<p><i>Duļas kabīnes krāns</i></p> <p><b>7102165</b> 35 mm</p> 

**MG - 1934** *Vannas krāns, izteka 300 mm*

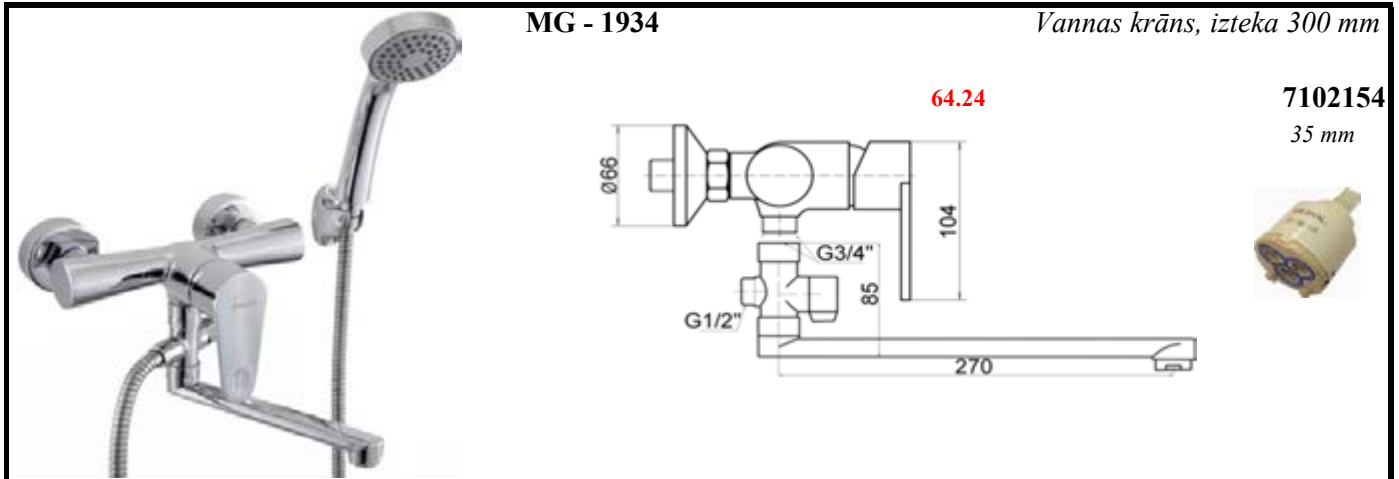

**7102154**  
35 mm

**MG - 1990** *Dušas krāns ar dušas stieni*

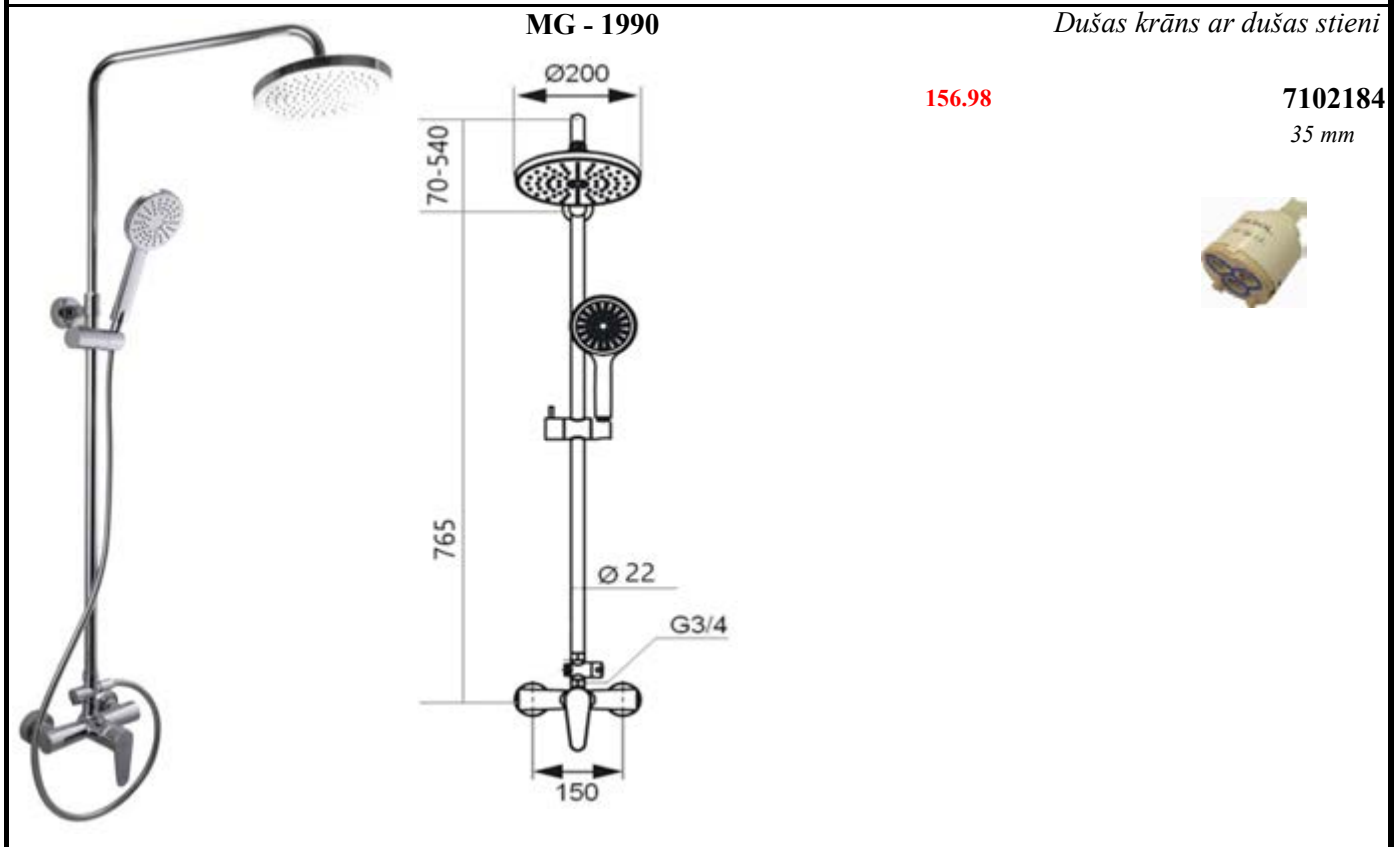





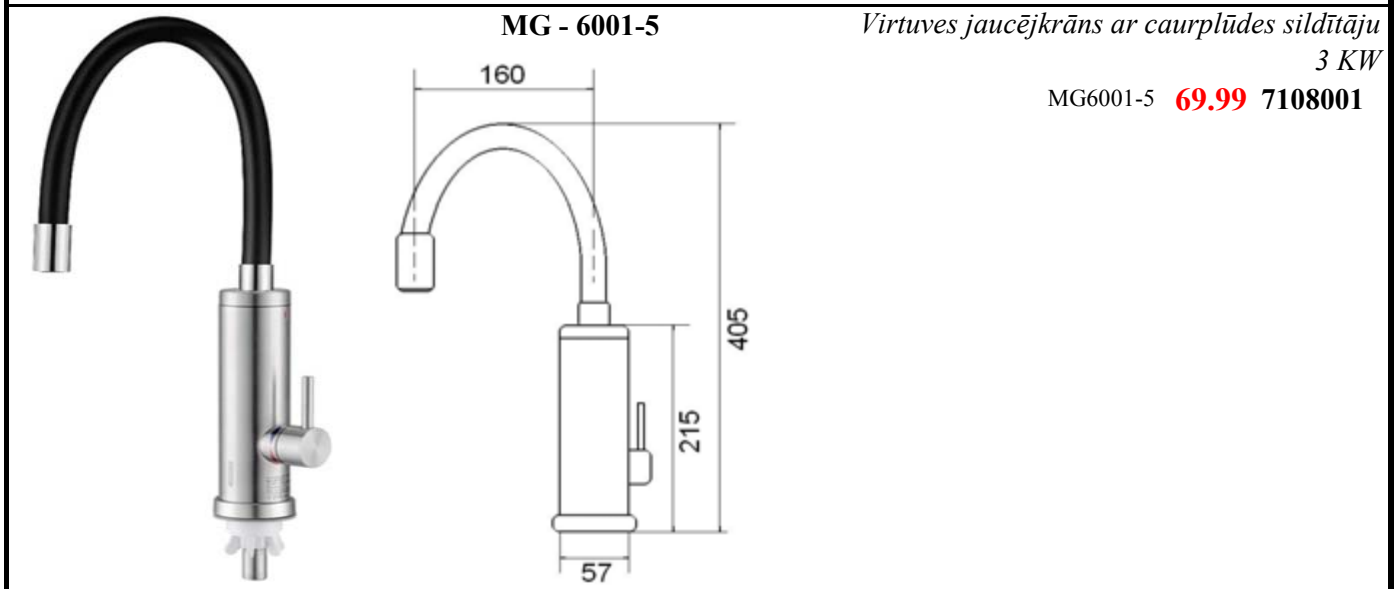

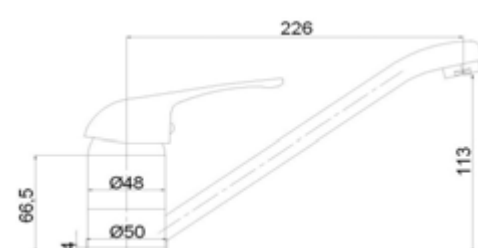

**156.98** **7102184**  
35 mm

**MG - 6001-5** *Virtuves jaucējkrāns ar caurplūdes sildītāju*

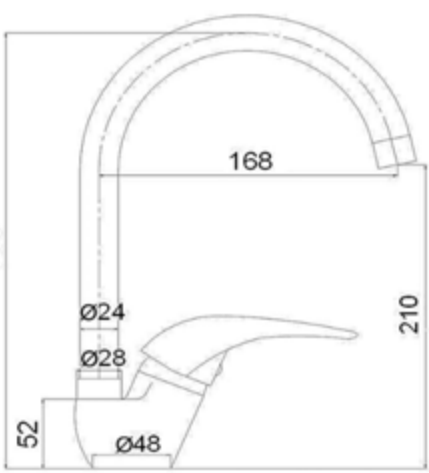

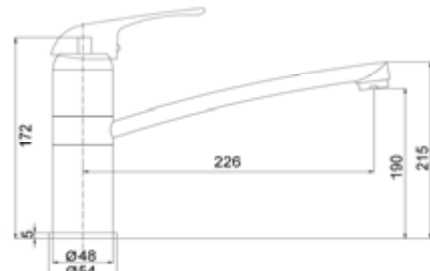

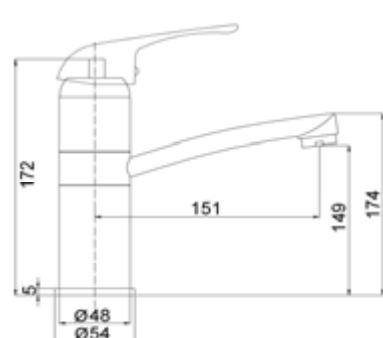





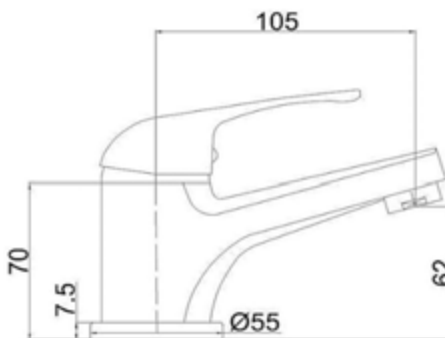

**3 KW**  
MG6001-5 **69.99** **7108001**

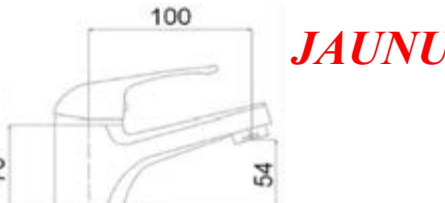
VEIKALS

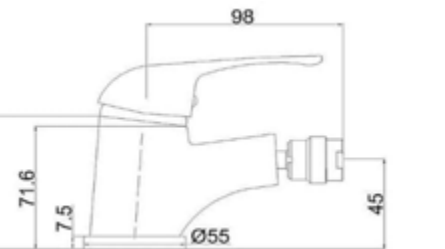
	<p><b>MG - 6250</b></p> 	<p><b>EUR</b></p> <p>31.07 31.07 36.21</p>	<p><i>Virtuves izlietnes krāns</i></p> <table border="0"> <tr> <td>JUPITS</td> <td><b>7103003</b></td> </tr> <tr> <td>URANS</td> <td><b>7103010</b></td> </tr> <tr> <td>LG</td> <td><b>7104005</b></td> </tr> </table> <p>JUPITS URANS 40 mm</p> 	JUPITS	<b>7103003</b>	URANS	<b>7103010</b>	LG	<b>7104005</b>
JUPITS	<b>7103003</b>								
URANS	<b>7103010</b>								
LG	<b>7104005</b>								
	<p><b>MG - 6255</b></p> 	<p>42.48 42.48 47.60</p>	<p><i>Virtuves izlietnes krāns</i></p> <table border="0"> <tr> <td>JUPITS</td> <td><b>7103009</b></td> </tr> <tr> <td>URANS</td> <td><b>7103012</b></td> </tr> <tr> <td>LG</td> <td><b>7103200</b></td> </tr> </table> <p>JUPITS URANS 40 mm</p> 	JUPITS	<b>7103009</b>	URANS	<b>7103012</b>	LG	<b>7103200</b>
JUPITS	<b>7103009</b>								
URANS	<b>7103012</b>								
LG	<b>7103200</b>								
	<p><b>MG - 6252</b></p> 	<p>41.43 41.43 46.56</p>	<p><i>Virtuves izlietnes krāns</i></p> <table border="0"> <tr> <td>JUPITS</td> <td><b>7103185</b></td> </tr> <tr> <td>URANS</td> <td><b>7103187</b></td> </tr> <tr> <td>LG</td> <td><b>7104012</b></td> </tr> </table> <p>JUPITS URANS 40 mm</p> 	JUPITS	<b>7103185</b>	URANS	<b>7103187</b>	LG	<b>7104012</b>
JUPITS	<b>7103185</b>								
URANS	<b>7103187</b>								
LG	<b>7104012</b>								
	<p><b>MG - 6253</b></p> 	<p>43.69 43.69</p>	<p><i>Virtuves izlietnes krāns</i></p> <table border="0"> <tr> <td>JUPITS</td> <td><b>7103205</b></td> </tr> <tr> <td>URANS</td> <td><b>7103206</b></td> </tr> </table> <p>JUPITS URANS 40 mm</p> 	JUPITS	<b>7103205</b>	URANS	<b>7103206</b>		
JUPITS	<b>7103205</b>								
URANS	<b>7103206</b>								

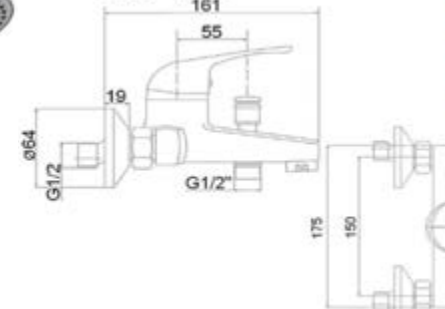

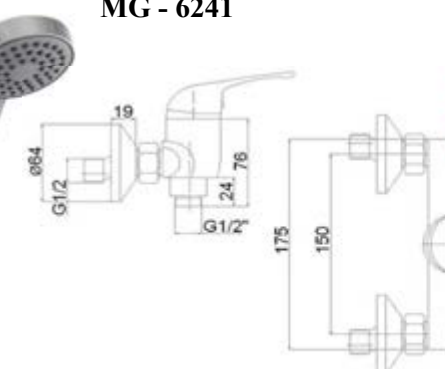







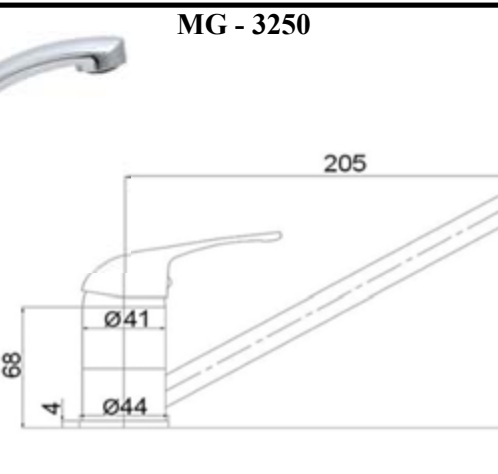

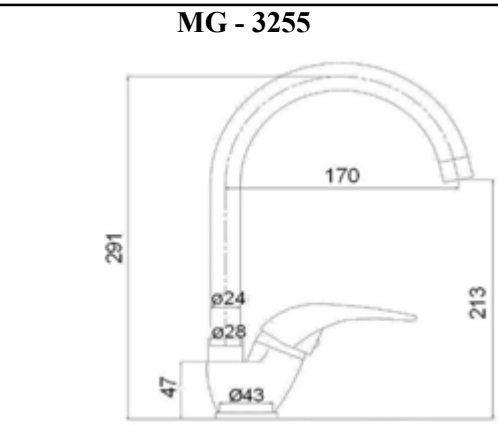
	<p><b>MG - 6260</b></p> 	<p>34.13 34.13 39.26</p>	<p><i>Keramiskās izlietnes krāns</i></p> <p>JUPITS 7103015 URANS 7103016 LG 7104004</p> <p>JUPITS URANS 40 mm</p> 
	<p><b>MG - 6270</b></p> 	<p>49.06 49.06</p> <p><b>JAUNUMS</b></p>	<p><i>Izlietnes krāns ar bidetu</i></p> <p>JUPITS 7103077 URANS 7103078</p> <p>JUPITS URANS 40 mm</p> 
	<p><b>MG - 6280</b></p> 	<p>32.40 32.40</p>	<p><i>Bidē krāns ar noteci</i></p> <p>JUPITS 7103019 URANS 7103020</p> <p>JUPITS URANS 40 mm</p> 
	<p><b>MG - 6221</b></p> 	<p>EUR</p> <p>45.79 45.79</p>	<p><i>Vannas krāns ar dušu</i></p> <p>JUPITS 7103051 URANS 7103052</p> <p>JUPITS URANS 40 mm</p> 
	<p><b>MG - 6241</b></p> 	<p>40.12 40.12 45.25</p>	<p><i>Krāns dušas kabīnei</i></p> <p>JUPITS 7103035 URANS 7103036 LG 7104009</p> <p>JUPITS URANS 40 mm</p> 

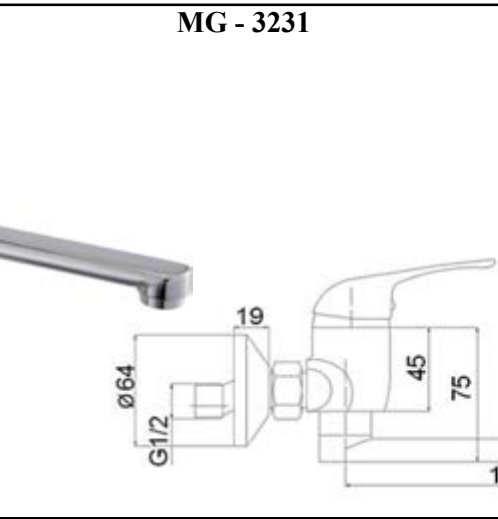

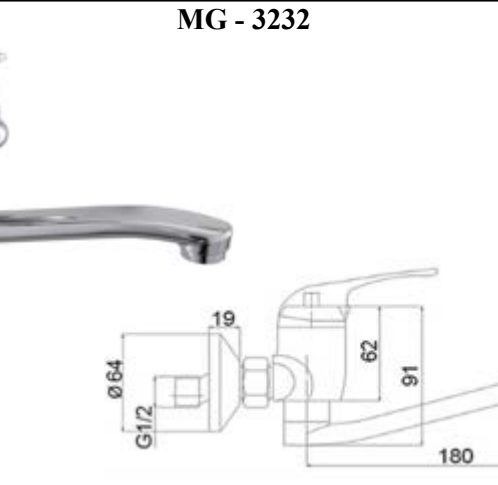





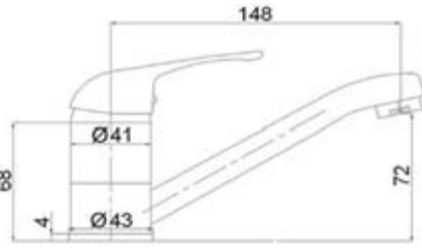

	<p><b>MG - 6233</b></p> <p>Pārslēdzējs</p>	<p><i>Vannas krāns, izteka 200 mm</i></p> <p><b>53.52</b> JUPITS <b>7103071</b> <b>53.52</b> URANS <b>7103072</b></p> <p>JUPITS URANS 40 mm</p>
	<p><b>MG - 6234</b></p> <p>Pārslēdzējs</p>	<p><i>Vannas krāns, izteka 300 mm</i></p> <p><b>55.13</b> JUPITS <b>7103031</b> <b>55.13</b> URANS <b>7103032</b></p> <p>JUPITS URANS 40 mm</p>
	<p><b>MG - 6235</b></p> <p>Pārslēdzējs</p>	<p><i>Vannas krāns, izteka 200 mm</i></p> <p><b>53.52</b> JUPITS <b>7103067</b> <b>53.52</b> URANS <b>7103068</b></p> <p>JUPITS URANS 40 mm</p>
	<p><b>MG - 6236</b></p> <p>Pārslēdzējs</p>	<p><i>Vannas krāns, izteka 300 mm</i></p> <p><b>55.13</b> JUPITS <b>7103027</b> <b>55.13</b> URANS <b>7103028</b></p> <p>JUPITS URANS 40 mm</p>

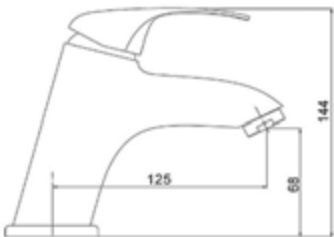
VEIKALS

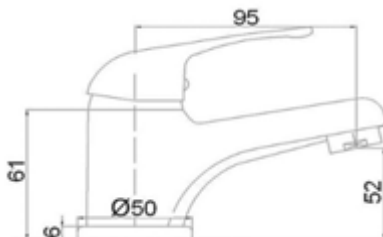

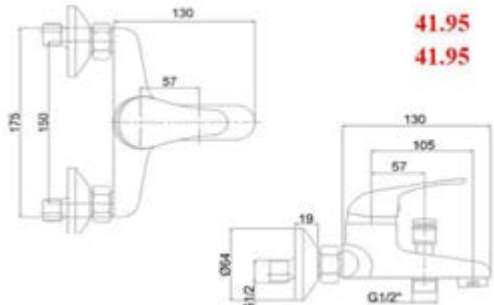

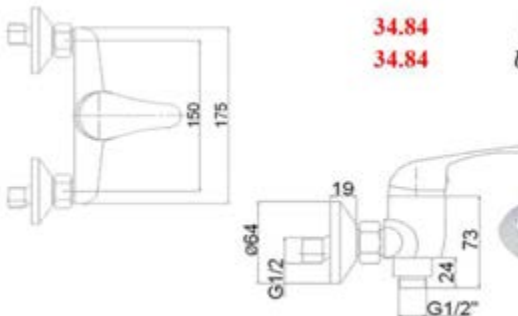



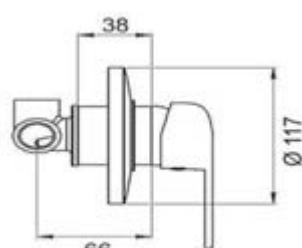

	<p><b>MG - 3250</b></p> 	<p><b>EUR</b></p> <p>26.39 26.39</p>	<p><i>Virtuves izlietnes krāns</i></p> <p>SATO <b>7102002</b> URANS <b>7102003</b></p> <p>SATO URANS 35 mm</p> 
	<p><b>MG - 3255</b></p> 	<p>37.54 37.54</p>	<p><i>Virtuves izlietnes krāns</i></p> <p>SATO <b>7102008</b> URANS <b>7102009</b></p> <p>SATO URANS 35 mm</p> 
	<p><b>MG - 3231</b></p> 	<p>35.52 35.52</p>	<p><i>Virtuves izlietnes krāns</i></p> <p>SATO <b>7102029</b> URANS <b>7102030</b></p> <p>SATO URANS 35 mm</p> 
	<p><b>MG - 3232</b></p> 	<p>35.52 35.52</p>	<p><i>Virtuves izlietnes krāns</i></p> <p>SATO <b>7102032</b> URANS <b>7102033</b></p> <p>SATO URANS 35 mm</p> 

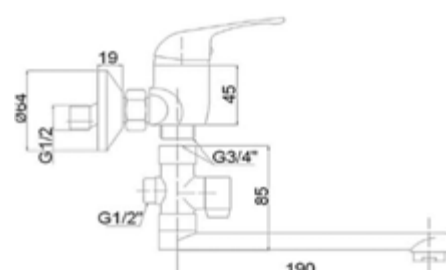
Sērija ECO

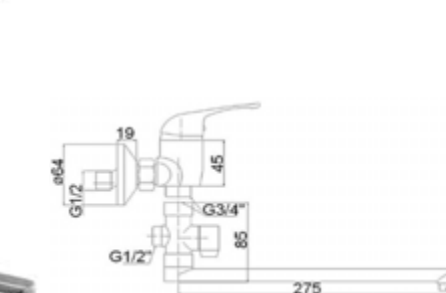

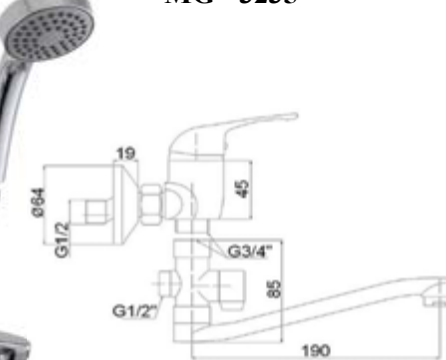

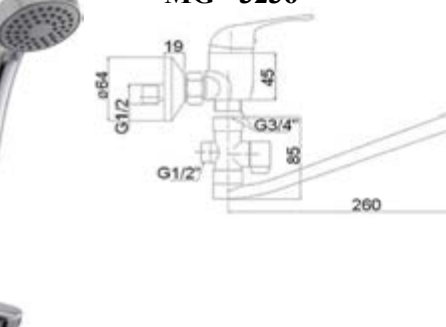



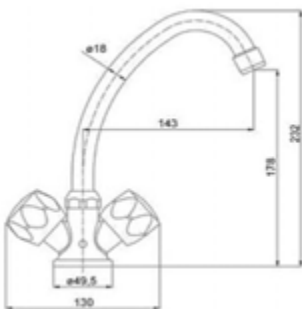

VEIKALS

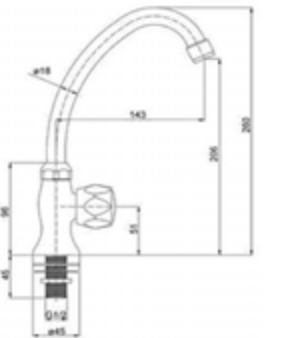
<b>MG - 3251</b>		<i>Izlietnes krāns, izteka 150 mm</i>	
		<b>25.97</b> <b>25.97</b>	<i>SATO</i> <b>7102005</b> <i>URANS</i> <b>7102006</b>
			<i>SATO</i> <i>URANS</i> <b>35 mm</b> 
<b>MG-3263</b>		<i>Keramiskās izlietnes krāns</i>	
		<b>32.55</b> <b>31.84</b>	<i>SATO</i> <b>7102166</b> <i>URANS</i> <b>7102167</b>
			<i>SATO</i> <i>URANS</i> <b>35 mm</b> 
<b>MG - 3260</b>		<i>Keramiskās izlietnes krāns</i>	
		<b>26.88</b> <b>26.88</b>	<i>SATO</i> <b>7102011</b> <i>URANS</i> <b>7102012</b>
			<i>SATO</i> <i>URANS</i> <b>35 mm</b> 
<b>MG - 3221</b>		<i>Vannas krāns ar dušu</i>	
		<b>41.95</b> <b>41.95</b>	<i>SATO</i> <b>7102038</b> <i>URANS</i> <b>7102039</b>
			<i>SATO</i> <i>URANS</i> <b>35 mm</b> 
<b>MG - 3241</b>		<i>Krāns dušas kabīnei</i>	
		<b>34.84</b> <b>34.84</b>	<i>SATO</i> <b>7102026</b> <i>URANS</i> <b>7102027</b>
			<i>SATO</i> <i>URANS</i> <b>35 mm</b> 

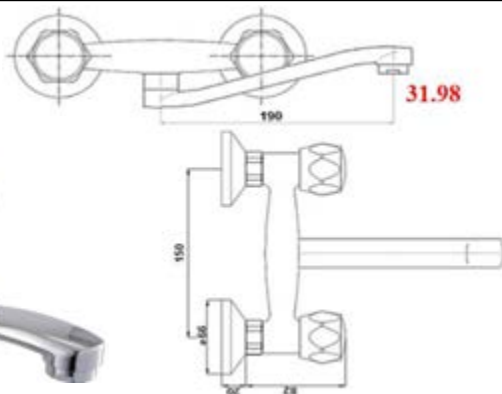

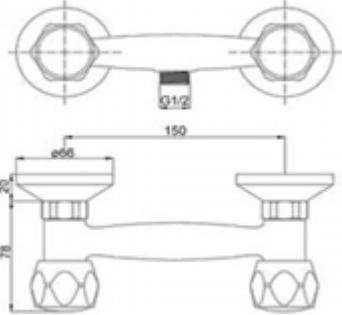

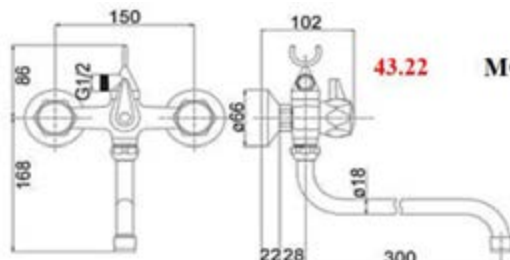





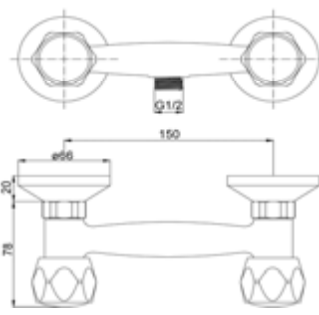

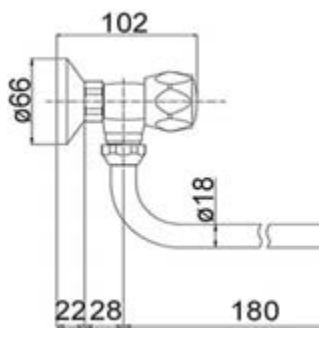

VEIKALS

	<p><b>MG - 3248</b></p> 	<p><b>EUR</b> 59.77 59.65</p>	<p>Zemapmetuma dušas krāns</p> <p>SATO <b>7102185</b> URANS <b>7102186</b></p> <p>SATO URANS 35 mm</p> 
	<p><b>MG - 3233</b></p> 	<p>43.50 43.50</p>	<p>Vannas krāns, izteka 200 mm</p> <p>SATO <b>7102053</b> URANS <b>7102054</b></p> <p>Pārslēdzējs SATO URANS 35 mm</p> 
	<p><b>MG - 3234</b></p> 	<p>45.99 45.99</p>	<p>Vannas krāns, izteka 300 mm</p> <p>SATO <b>7102023</b> URANS <b>7102024</b></p> <p>Pārslēdzējs SATO URANS 35 mm</p> 
	<p><b>MG - 3235</b></p> 	<p>43.50 43.50</p>	<p>Vannas krāns, izteka 200 mm</p> <p>SATO <b>7102050</b> URANS <b>7102051</b></p> <p>Pārslēdzējs SATO URANS 35 mm</p> 
	<p><b>MG - 3236</b></p> 	<p>45.99 45.99</p>	<p>Vannas krāns, izteka 300 mm</p> <p>SATO <b>7102020</b> URANS <b>7102021</b></p> <p>Pārslēdzējs SATO URANS 35 mm</p> 

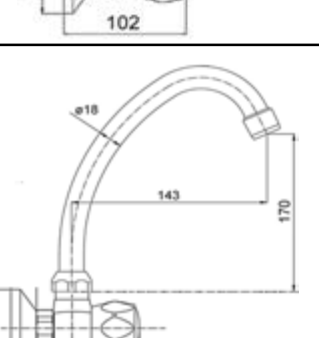
VEIKALS

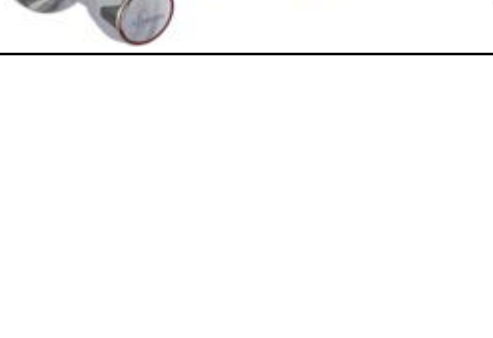
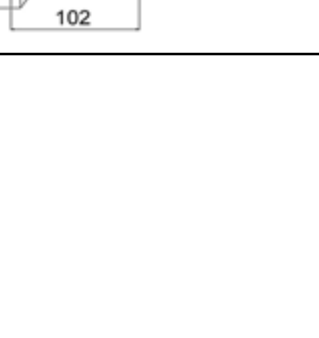





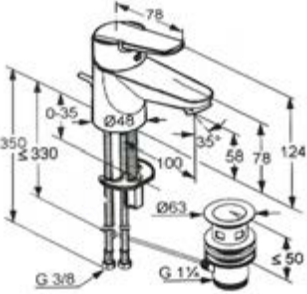

		EUR	<i>Virtuves izlietnes krāns</i>		
		29.20	MG-2150	RING	7101001
		30.58	MG-2150/R	RETRO	7101002
					
		18.90	MG-2151	RING	7101003
		19.60	MG-2151	RETRO	7101010
		31.98	MG-2132	RING	7101008
					
		25.72	MG-2140	RING	7101004
		27.12	MG-2140/R	RETRO	7101005
		41.81	MG-2134	RING	7101006
		43.22	MG-2134/R	RETRO	7101007
					

VEIKALS

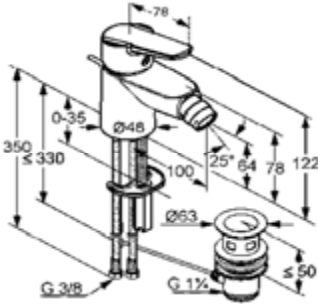
				<p>Jaucējkrāns no sienas (izeja 3/4")</p> <p>EUR 27.55</p>	<p>MG-2130 RING 7101011</p>	
				<p>30.22</p>	<p>MG-2130/R RETRO 7101012</p>	
				<p>30.75</p>	<p>MG-2145 RING 7101013</p>	
				<p>33.42</p>	<p>MG-2145/R RETRO 7101014</p>	
				<p>30.75</p>	<p>MG-2146 RING 7101015</p>	
				<p>33.42</p>	<p>MG-2146/R RETRO 7101016</p>	
				<p>30.75</p>	<p>MG-2147 RING 7101017</p>	
				<p>33.42</p>	<p>MG-2147/R RETRO 7101018</p>	

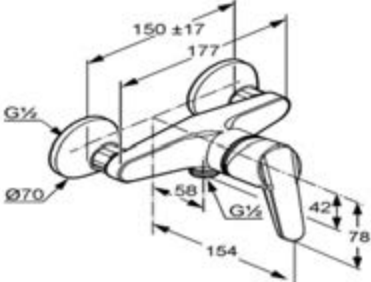
# JAUCĒJKRĀNI AR SVIRAS ROKTURI

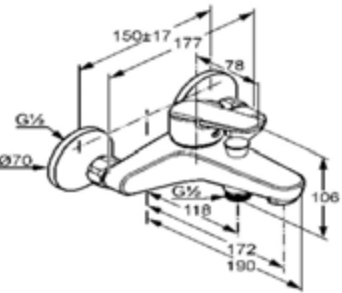
VEIKALS  
EUR

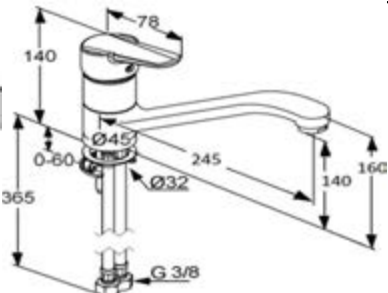
	<p>D-VISE</p> 	<p>371810590</p>	<p><i>Keramiskās izlietnes krāns</i></p> <p>100.73 0802017</p>
	<p>D-VISE</p> 	<p>375320590</p>	<p><i>Bidē krāns</i></p> <p>103.06 0802018</p>
	<p>D-VISE</p> 	<p>378420590</p>	<p><i>Dušas krāns</i></p> <p>101.61 0802045</p>
	<p>D-VISE</p> 	<p>376820590</p>	<p><i>Vannas krāns</i></p> <p>130.17 0802030</p>
	<p>D-VISE</p> 	<p>379550590</p>	<p><i>Virtuves izlietnes krāns</i></p> <p>104.37 0802003</p>





JAUCĒJKRĀNI AR SVIRAS ROKTURI











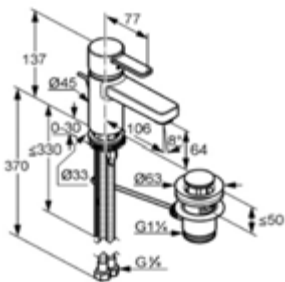

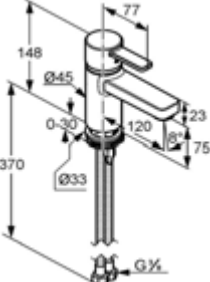

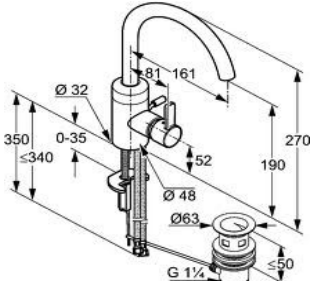

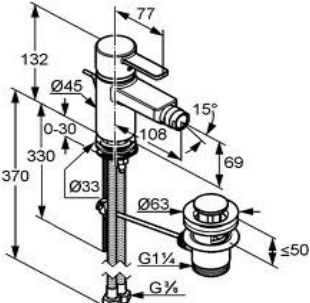

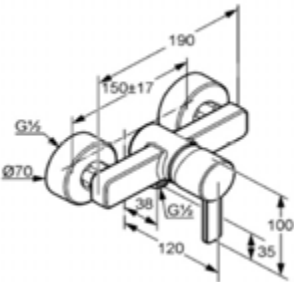

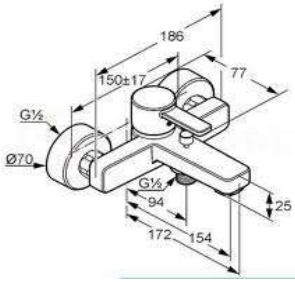

VEIKALS  
EUR

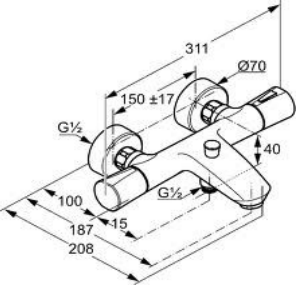
		<p>LOGO NEO</p>	<p>Keramiskās izlietnes krāns</p>
<p>372800575</p>	<p>80.74</p>	<p>0802034</p>	
		<p>LOGO NEO</p>	<p>Bidē krāns</p>
<p>375310575</p>	<p>124.12</p>	<p>0802101</p>	
		<p>LOGO NEO</p>	<p>Vannas krāns</p>
<p>376810575</p>	<p>125.38</p>	<p>0802001</p>	
		<p>LOGO NEO</p>	<p>Dušas krāns</p>
<p>378410575</p>	<p>111.31</p>	<p>0802006</p>	
		<p>LOGO NEO</p>	<p>Virtuves izlietnes krāns</p>
<p>379130575</p>	<p>120.34</p>	<p>0802008</p>	

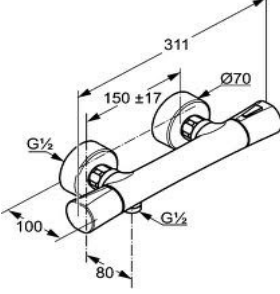
## JAUCĒJKRĀNI AR SVIRAS ROKTURI

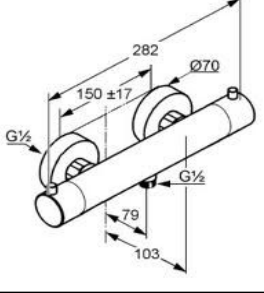

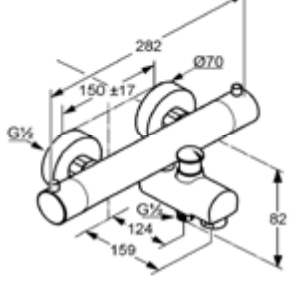

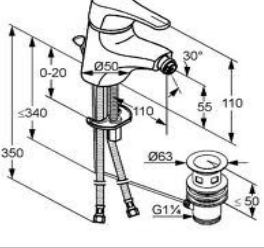

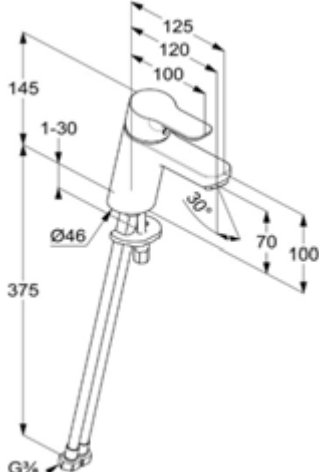

VEIKALS  
EUR

		ZENTA	Keramiskās izlietnes krāns	<b>382500575</b> hroms <b>184.75</b> <b>0802086</b> <b>382509175</b> balts/hroms <b>212.80</b> <b>0802016</b>
		ZENTA XL	Keramiskās izlietnes krāns (bez noteces)	<b>382620575</b> <b>191.23</b> <b>0802033</b>
		ZENTA	Keramiskās izlietnes krāns (augstais)	<b>382550575</b> <b>314.67</b> <b>0802087</b>
		ZENTA	Bidē krāns	<b>385300575</b> hroms <b>239.78</b> <b>0802088</b> <b>385309175</b> balts/hroms
		ZENTA	Dušas krāns	<b>388700575</b> hroms <b>211.34</b> <b>0802090</b> <b>388709175</b> balts/hroms
		ZENTA	Vannas krāns	<b>386700575</b> hroms <b>262.01</b> <b>0802089</b> <b>386709175</b> balts/hroms

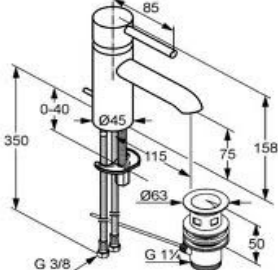
 	<p><b>ZENTA</b> <i>Vannas krāns ar termostatu</i></p> <p><b>351010538</b> hroms <b>265.74</b> <b>0805015</b>  <b>351018638</b> melns/hroms  <b>351019138</b> balts/hroms</p>
 	<p><b>ZENTA</b> <i>Dušas krāns ar termostatu</i></p> <p><b>351000538</b> hroms <b>195.29</b> <b>0805014</b>  <b>351009138</b> balts/hroms</p>
 	<p><b>OBJEKTA</b> <i>Dušas krāns ar termostatu</i></p> <p><b>352000538</b> <b>341.24</b> <b>0805004</b></p>
 	<p><b>OBJEKTA</b> <i>Vannas krāns ar termostatu</i></p> <p><b>352600538</b> <b>314.29</b> <b>0805005</b></p>
 	<p><b>385320575</b> <b>TERCIO</b> <i>Bidē krāns</i></p> <p><b>127.95</b> <b>0802055</b></p> <p><b>Izpārdošana</b> <b>50.00</b></p>

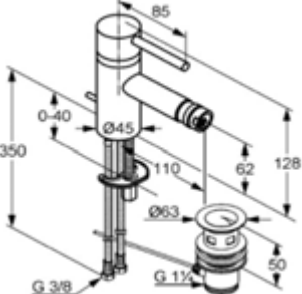
**JAUCĒJKRĀNI AR SVIRAS ROKTURI**

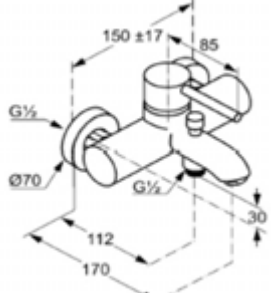

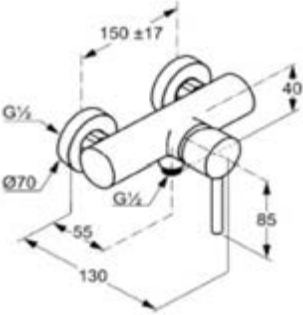



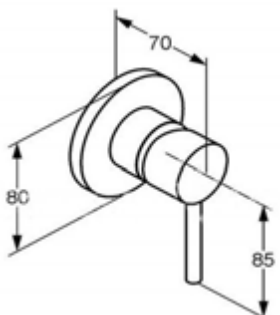

**VEIKALS  
EUR**

		<p style="text-align: right;"><i>Keramiskās izlietnes krāns</i></p> <p><b>37280565</b>      <b>93.92</b>      <b>0802125</b></p> <p><b>PURE&amp;EASY</b></p>
		<p><b>BOZZ</b>      <i>Keramiskās izlietnes krāns</i></p> <p><b>382910576</b>      <b>164.42</b>      <b>0802092</b></p>
		<p><b>BOZZ</b>      <i>Bidē krāns</i></p> <p><b>385330576</b>      <b>267.73</b>      <b>0802093</b></p>
		<p><b>BOZZ</b>      <i>Vannas krāns</i></p> <p><b>386910576</b>      <b>292.31</b>      <b>0802094</b></p>
		<p><b>BOZZ</b>      <i>Dušas krāns</i></p> <p><b>388310576</b>      <b>224.76</b>      <b>0802095</b></p>

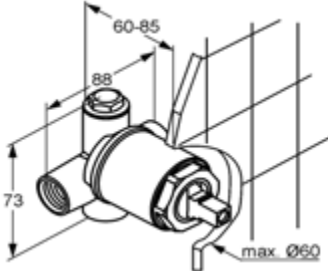

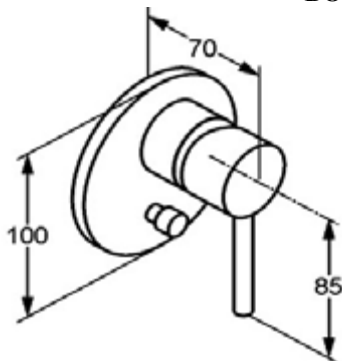
## JAUCĒJKRĀNI AR SVIRAS ROKTURI

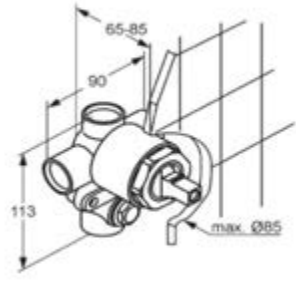
**VEIKALS  
EUR**

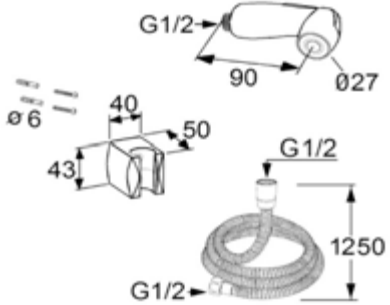
		<b>BOZZ</b>	<i>Dekoratīvā daļa iebūv.maisītājam</i>	<b>389250576</b>	<b>74.28</b>	<b>0810023</b>
		<b>BOZZ</b>	<i>Iebūvējamā daļa</i>	<b>38826 N</b>	<b>71.58</b>	<b>0802041</b>
		<b>BOZZ</b>	<i>Dekoratīvā iebūv.daļa v/d maisītājam</i>	<b>387160576</b>	<b>141.20</b>	<b>0810022</b>
		<b>BOZZ</b>	<i>Iebūvējamā daļa v/d</i>	<b>38624 N</b>	<b>149.51</b>	<b>0802068</b>
		<b>BOZZ</b>	<i>Bidetta komplekts</i>	<b>730420500</b>	<b>42.00</b>	<b>0839048</b>









# JAUCĒJKRĀNI AR SVIRAS ROKTURI

VEIKALS  
EUR

		<b>ZENTA</b>	<i>Virtuves izlietnes krāns</i>		
		<b>389730575</b>	hroms	<b>265.71</b>	<b>0802098</b>
		<b>389738675</b>	melns/hroms	<b>326.73</b>	<b>0802106</b>
		<b>389739175</b>	balts/hroms		
		<b>BINGOSTAR</b>	<i>Virtuves izlietnes krāns</i>		
		<b>428030578</b>		<b>305.80</b>	<b>0802076</b>
		<b>BINGOSTAR</b>	<i>Virtuves izlietnes krāns ar izvelkamu dušu</i>		
		<b>428510575</b>		<b>333.33</b>	<b>0802081</b>
		<b>SCOPE XL</b>	<i>Virtuves izlietnes krāns</i>		
		<b>339300575</b>		<b>124.17</b>	<b>0802100</b>
		<b>L-INE</b>	<i>Virtuves izlietnes krāns</i>		
		<b>428140577</b>		<b>175.20</b>	<b>0802097</b>
		<b>BINGO STAR S</b>	<i>Virtuves izlietnes krāns</i>		
		<b>468030578</b>		<b>251.70</b>	<b>0802120</b>

## JAUCĒJKRĀNI AR DIVIEM ROKTURIEM

VEIKALS

		598	14.54	ORCHIDEA	<i>Izlietnes krāns</i> 0101056
		612 ( izteka 18x150 )	14.02	ABS	0101091
			15.30	ORCHIDEA	0101092
			35.45	LIBERTY	0101095
		612/K ( izteka 18x150 )	32.86	ORCHIDEA	0101096
			40.84	LIBERTY	0101099
		624 ( izteka 18x200 )	14.70	ABS	0101118
			16.41	ORCHIDEA	0101119
			36.51	LIBERTY	0101122
		624/K(izteka 18x200)	33.97	ORCHIDEA	0101123
			41.93	LIBERTY	0101126
		652	18.36	ABS	<i>Izlietnes krāns no sienas ar "S" izteku vienam ūdenim</i> 0101188
		653 ( izteka 16X150 )	18.36	ABS	<i>Izlietnes krāns ar "J" izteku vienam ūdenim</i> 0101192
		653.2 ( izteka 16X200 )	19.93	ABS	0101294
		654	18.36	ABS	<i>Izlietnes krāns ar "U" izteku vienam ūdenim</i> 0101196
		658	11.11	ORCHIDEA	<i>Izlietnes krāns vienam ūdenim</i> 0101204
		656	11.80	ORCHIDEA	0101200



## JAUCĒJKRĀNI AR DIVIEM ROKTURIEM

VEIKALS

*Keramiskas izlietnes krāns ar dušu*



1050

EUR

89.34

89.34

PANTHER

RING

0102093

0102094

*Keramiskas izlietnes krāns ar dušu ( bez komplekta )*

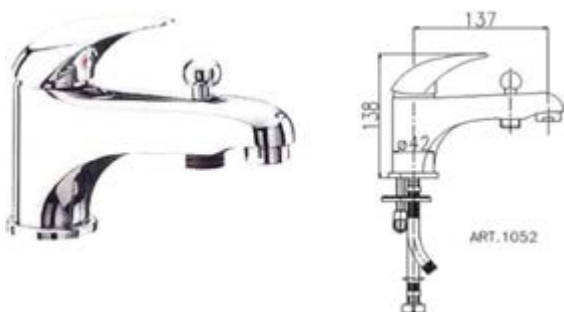

1052

79.15

79.15

PANTHER

RING

0102095

0102096

*Vannas krāns ar grozāmo izteku,  
pārslēdzējs art. 0396*

1065.1-150

76.18

76.18

PANTHER

RING

0102284

0102205

1065.1-200

76.18

76.18

PANTHER

RING

0102140

0102141

1065.1-300

88.70

88.70

PANTHER







RING

0102143

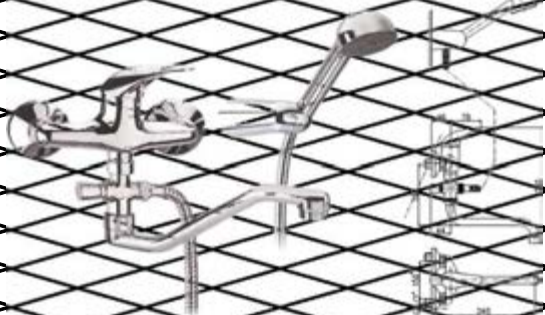
0102144

## JAUCĒJKRĀNI AR SVIRAS ROKTURI

### VEIKALS

	1065.1-075	76.18	PANTHER	0102221
		76.18	RING	0102247
	1066	90.21	PANTHER	0102015
		90.21	RING	0102086
	1069	35.66	PANTHER	0102033
		35.66	RING	0102066
	1069-130	47.88	PANTHER	0102224
		47.88	RING	0102225
	1070	17.00	PANTHER	0102036
		17.00	RING	0102077
	1076	11.51	PANTHER	0102099
		11.51	RING	0102098

**JAUCĒJKRĀNI AR SVIRAS ROKTURI**

**VEIKALS**

*Izlietnes krāns ar izvelkamu izteku*

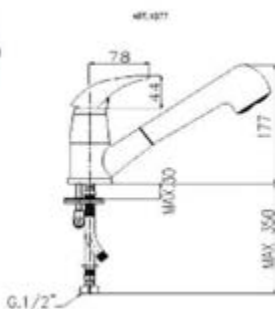

1077

**EUR**

73.67

73.67

PANTHER

RING

0102102

0102101

*Izlietnes krāns, 130 mm*



1079

51.40

51.40

PANTHER

RING

0102063

0102083

*Virtuves izlietnes krāns*

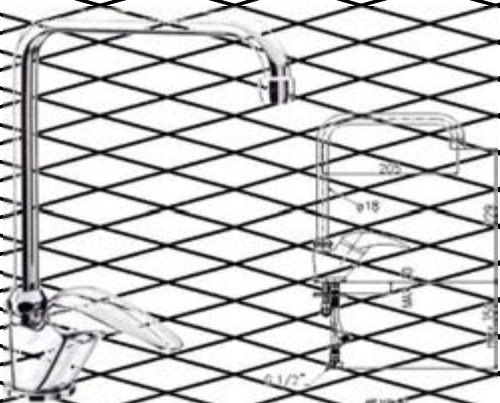

1079-67

43.52

43.52

PANTHER

RING

0102212

0102214

*Virtuves izlietnes krāns*

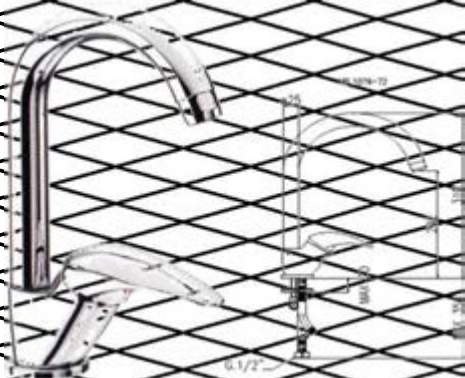

1079-72

52.86

52.86

PANTHER

RING

0102213

0102215

# JAUCĒJKRĀNI AR SVIRAS ROKTURI

VEIKALS

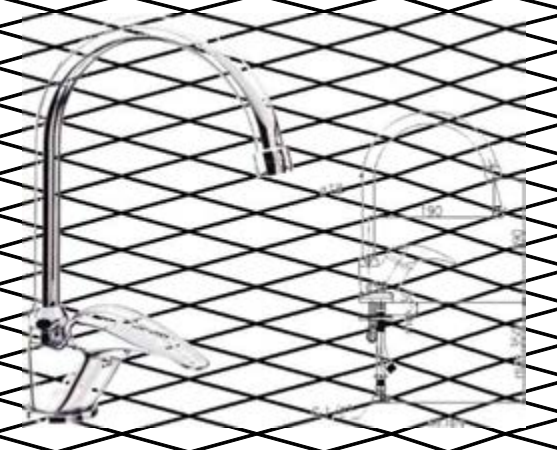
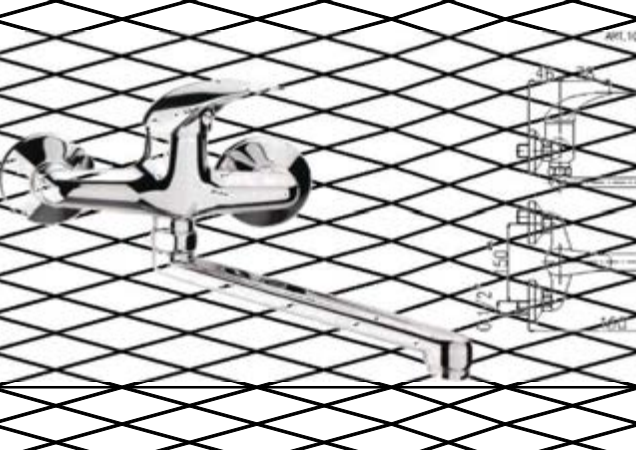
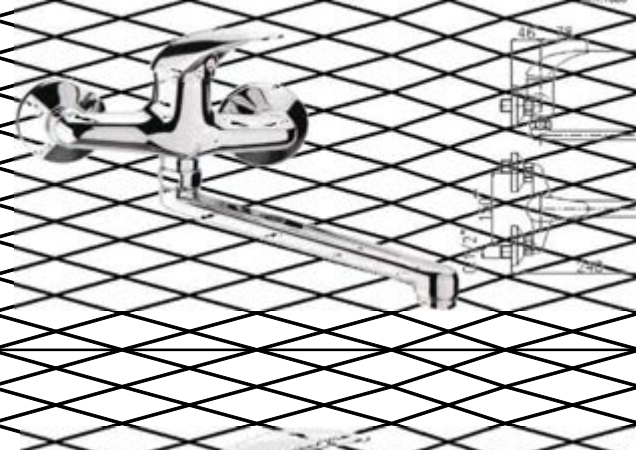
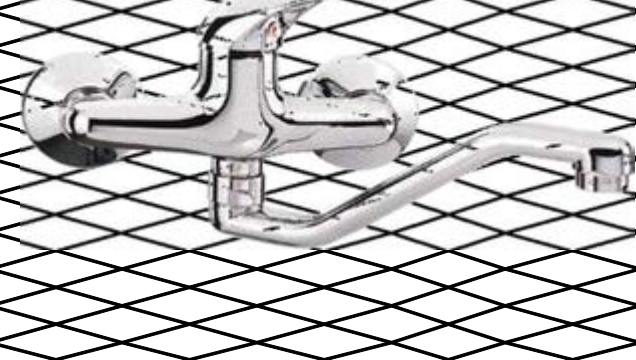
		<i>KĪTUVES IZLIETNES KRĀNS</i>	
	1079-G	41.86	PANTHER 0102706
		41.86	RING 0102708
		<i>IZLIETNES KRĀNS, 150 mm</i>	
	1080-150	51.24	PANTHER 0102152
		51.24	RING 0102153
		<i>IZLIETNES KRĀNS, 200 mm</i>	
	1080-200	51.24	PANTHER 0102051
		51.24	RING 0102065
		<i>IZLIETNES KRĀNS, 200 mm, LIEKTA</i>	
	1081	53.57	PANTHER 0102127
		53.57	RING 0102128

**JAUCĒJKRĀNI AR SVIRAS ROKTURI**

VEIKALS

*Izlietnes krāna korpusi*

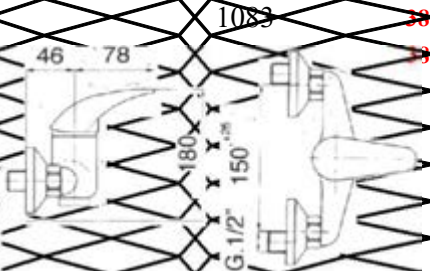
		1083	38.68	PANTHER	0102060
			13.68	RING	0102068

*Divdaļīgs krāns, frizieru*

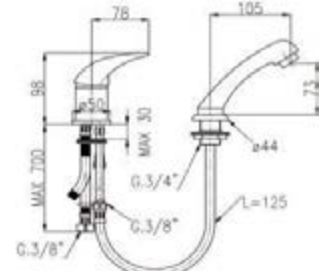
	MP480-10	81.24	PANTHER	0102288
				

*Izlietnes krāns vienam ūdenim*

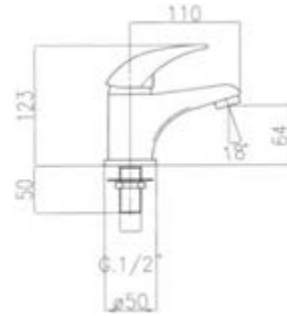
		1092	57.79	PANTHER	0102110
			65.08	RING	0102111

*Virtuves izlietnes krāns, vienam ūdenim*

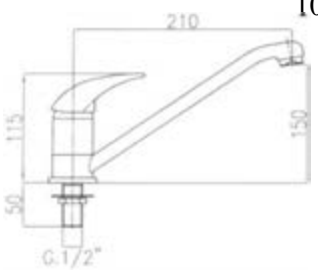
		1094	64.33	PANTHER	0102107
			64.33	RING	0102108

*Virtuves izlietnes krāns ar dušu*

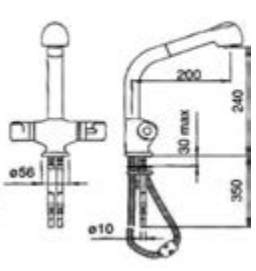
		211.93	<b>93.50</b>		0105005
			<b>230.51</b>		

VEIKALS

Keramiskās izlietnes krāns

EUR



**ZEPHYR 8001**

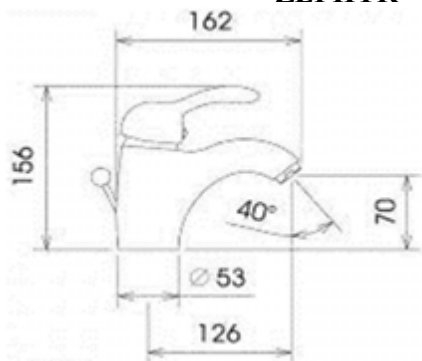

HR/MATĒTS **49.50** 0503016

**IZPĀRDOŠANA**

**40.91**

Vairumcena bez PVN

Bidē krāns



**ZEPHYR 8011**

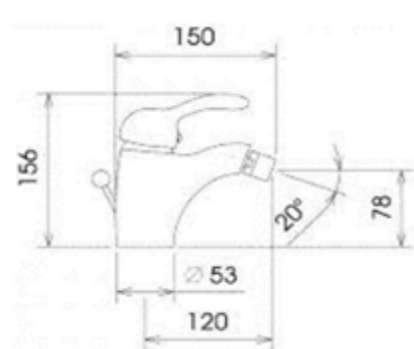

HR/MATĒTS **41.00** 0503029

**IZPĀRDOŠANA**

**33.88**

Vairumcena bez PVN

HR/MATĒTS **49.00** 0503017

**IZPĀRDOŠANA**

**40.49**

Vairumcena bez PVN

Vannas krāns ar dušas komplektu



**ZEPHYR 8020**

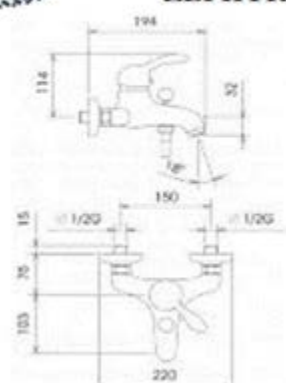

HR/KOKS **69.00** 0503018

HR/MATĒTS **80.00** 0503019

**IZPĀRDOŠANA**

**57.02**

**66.12**

Vairumcena bez PVN

Keramiskās izlietnes krāns



**SPLIT 5000**

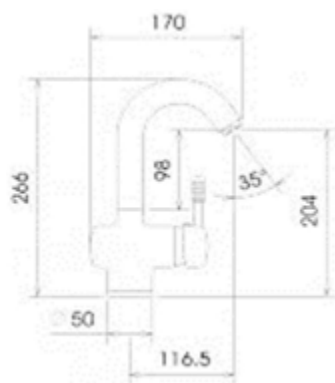

HR/MATĒTS **51.00** 0503013

**IZPĀRDOŠANA**

**42.15**

Vairumcena bez PVN

**VEIKALS**

*Keramiskās izlietnes krāns*

**EUR**

**MAXIMA 7000 HR/MATĒTS 70.00 0503025**

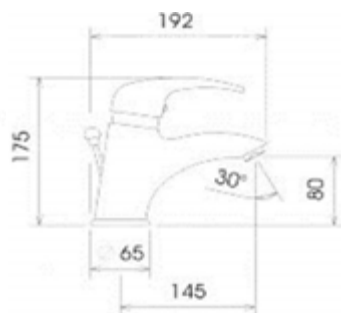

**IZPĀRDOŠANA**

**57.85**

**Vairumcena bez PVN**

*Bidē krāns*

**MAXIMA 7010 HROMS 57.00 0503021**

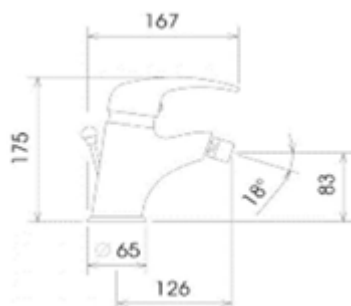

**IZPĀRDOŠANA**

**47.11**

**Vairumcena bez PVN**

*Vannas krāns ar dušas komplektu*

**MAXIMA 7020 HROMS 83.00 0503022**

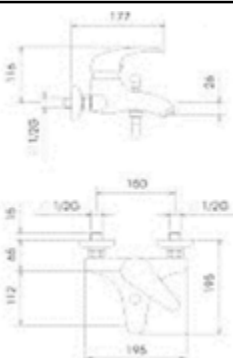

**IZPĀRDOŠANA**

**68.59**

**Vairumcena bez PVN**

*Izlietnes krāns*

**MAXIMA 7100 HR/MATĒTS 201.51 0503015**

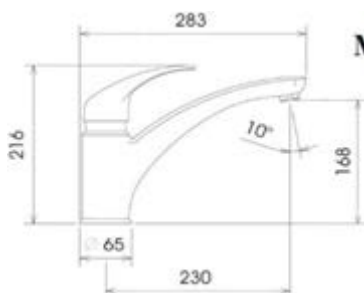

*Izlietnes krāns (nolocāms)*

**SPLIT 5114 HR/MATĒTS 84.00 0503014**

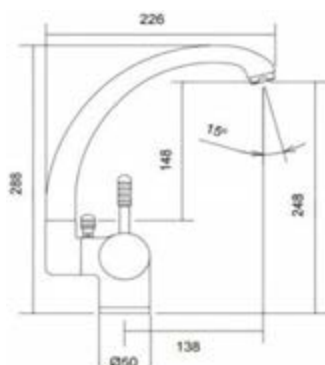

**IZPĀRDOŠANA**

**69.42**

**Vairumcena bez PVN**

**VEIKALS**

		<p><b>NEW PRO 42001 CSHROMS</b></p>	<p><i>Keramiskās izlietnes krāns</i>  <b>EUR 93.14 0502203</b></p>
		<p><b>NEW PRO 42011 CSHROMS</b></p>	<p><i>Bidē krāns</i>  <b>95.22 0502204</b></p>
		<p><b>NEW PRO 42020 S HROMS</b></p>	<p><i>Vannas krāns</i>  <b>129.37 0502205</b></p>
		<p><b>NEW PRO 42030 HROMS</b></p>	<p><i>Dušas krāns</i>  <b>108.68 0502208</b></p>
		<p><b>NEW PRO 42050 HROMS</b></p>	<p><i>Zemapmetuma dušas krāns</i>  <b>113.85 0502206</b></p>
		<p><b>NEW PRO 42050 R HROMS</b></p>	<p><i>Zemapmetuma vannas krāns</i>  <b>168.01 0502207</b></p>



**VEIKALS**

*Vannas krāns ar dušas komplektu*

**SPLIT** 5020 HR/MATĒTS **EUR 65.00** **0503012**

**IZPĀRDOŠANA**

**53.72**

Vairumcena bez PVN



**TOWER TECH** *Keramiskās izlietnes krāns*

12001 HROMS **136.61** **0502039**

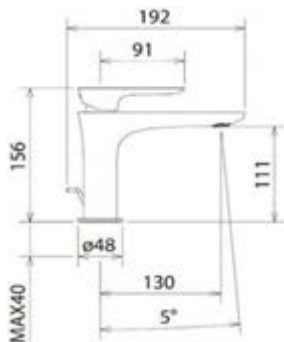

**LAGHI** *Keramiskās izlietnes krāns (augstais)*

44001 TC HROMS **202.66** **0502086**

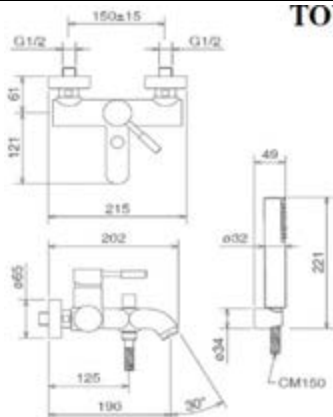

**TOWER TECH** *Vannas krāns ar dušas komplektu*

12019 HROMS **252.79** **0502013**

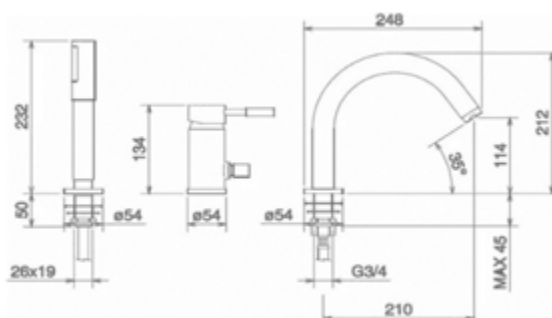

**TOWER TECH** *Krāns uz vannas malas 3-daļīgs*

12045EX HROMS **326.92** **0502053**

VEIKALS

*Bidē krāns*

**EUR**  
**138.62 0502033**

**TOWER TECH 12011 HROMS**

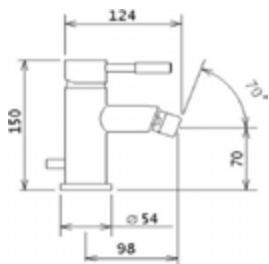

*Izlietnes krāns*

**136.32 0502113**

**TOWER TECH 12600/28 HROMS**

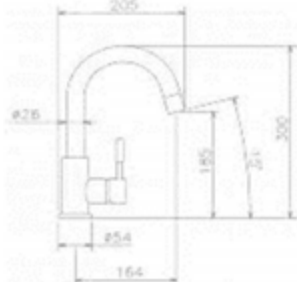

*Izlietnes krāns no sienas (divdaļīgs)*

**159.08 0502012**

**TOWER TECH 12200 HROMS**

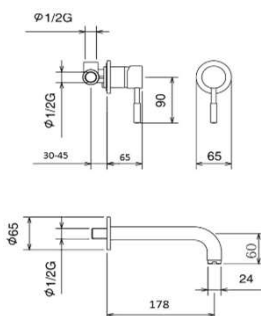

*Izlietnes krāns*

**206.93 0502044**

**TOWER TECH 12191 HROMS**

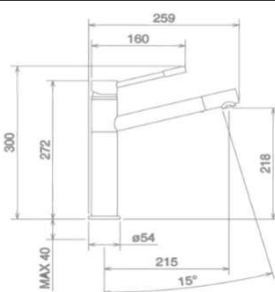

*Zemapmetuma dušas krāns ar pārslēdzēju*

**135.61 0502102**

**TOWER TECH 12050/R HROMS**

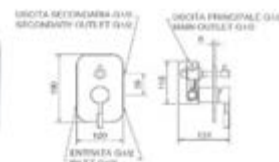
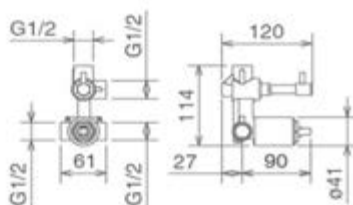

*Dušas kabīnes krāns*

**146.67 0502042**

**TOWER TECH 12030 HROMS**

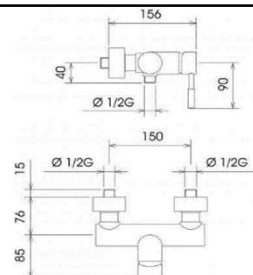

## JAUCĒJKRĀNI AR SVIRAS ROKTURI

VEIKALS

*Keramiskās izlietnes krāns ar noteci*

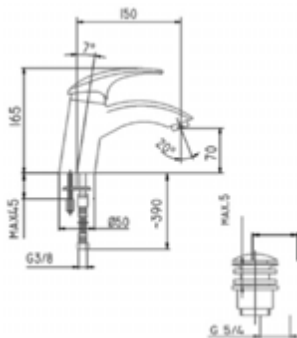

AMETYST 402-815-00 **91.92** 0703004

*Dušas krāns*

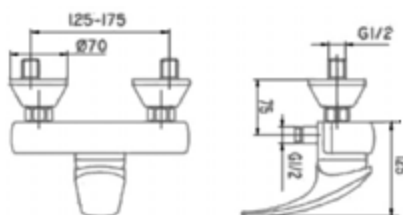

AMETYST 406-010-00 **43.00** 0703003

**IZPĀRDOŠANA**

*Virtuves izlietnes krāns ar izvelkamu dušu*

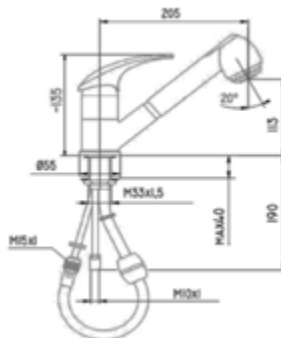

AMETYST 403-110-00 **48.00** 0703041

**IZPĀRDOŠANA**

*Virtuves izlietnes krāns*

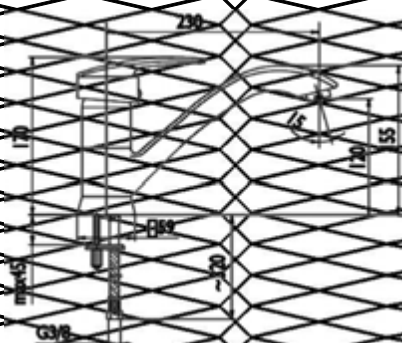

RUBIN 565-915-00 **75.68** 0703045

*Dušas krāns*



RUBIN 566-010-00 **34.00** 0703050

**IZPĀRDOŠANA**

# JAUCĒJKRĀNI AR SVIRAS ROKTURI

VEIKALS



*Virtuves izlieņes krāns*

**CYRKON** 582-712-00 **126.81** 0703020



*Dušas krāns*

**GRANIT** 486-020-00 **39.00** 0703016

**IZPĀRDOŠANA**

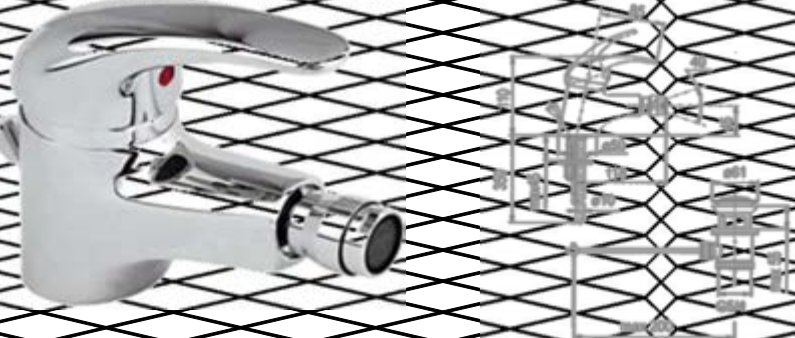

*Bidē krāns ar noteci*

**NEFRYT** 507-915-00 **41.87** 0703038



*Virtuves izlieņes krāns ar grozāmu izteku*

**NEFRYT** 507-915-00 **48.61** 0703035

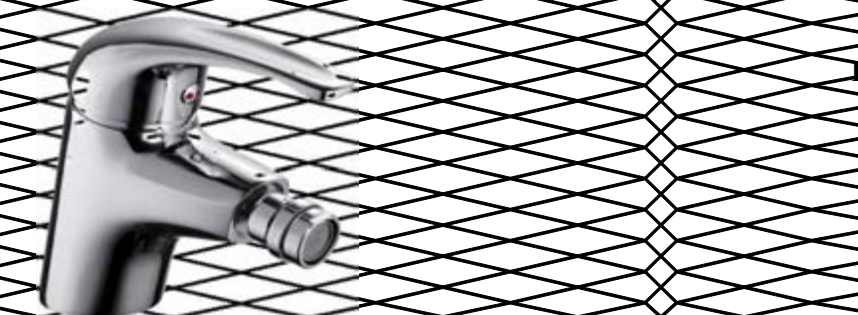

*Bidē krāns ar noteci*

**PIRYT** 447-945-00 **48.15** 0703053

# JAUCĒJKRĀNI AR SVIRAS ROKTURI

VEIKALS

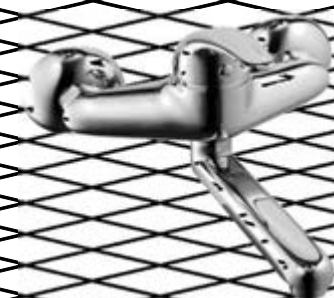
*Dušas krāns*PIRYT 446-040-00 **54.85** 0703054*Vannas krāns ar grozāmu izteku, 350 mm*PIRYT 448-740-00 **88.75** 0703019*Virtuves izliešnes krāns no sienas*PIRYT 440-840-00 **63.01** 0703066*Virtuves izlietnes krāns no sienas*PIRYT 440-940-00 **34.00** 0703056**IZPĀRDOŠANA***Virtuves izlietnes krāns*PIRYT 443-140-00 **46.00** 0703058**IZPĀRDOŠANA**

## JAUCĒJKRĀNI AR SVIRAS ROKTURI

VEIKALS

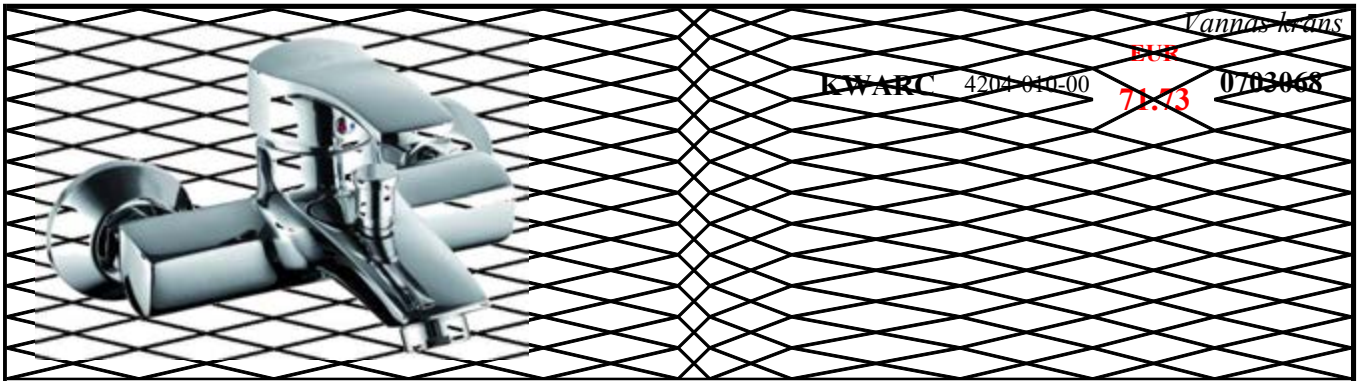
*Vannas krāns*

KWARC 4204-010-00

EUR

71.73

0703068

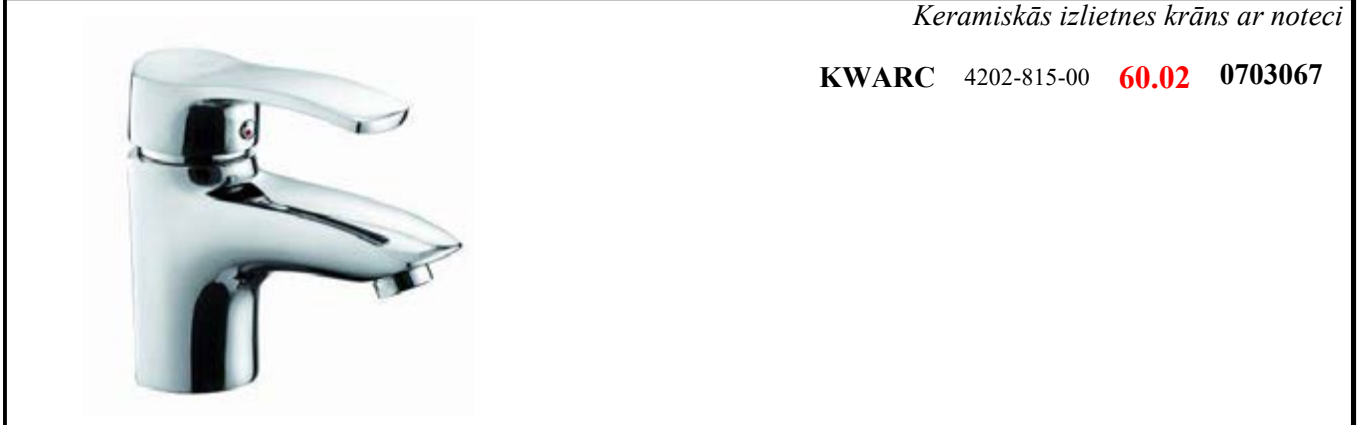
*Keramiskās izlietnes krāns ar noteci*

KWARC 4202-815-00

60.02

0703067

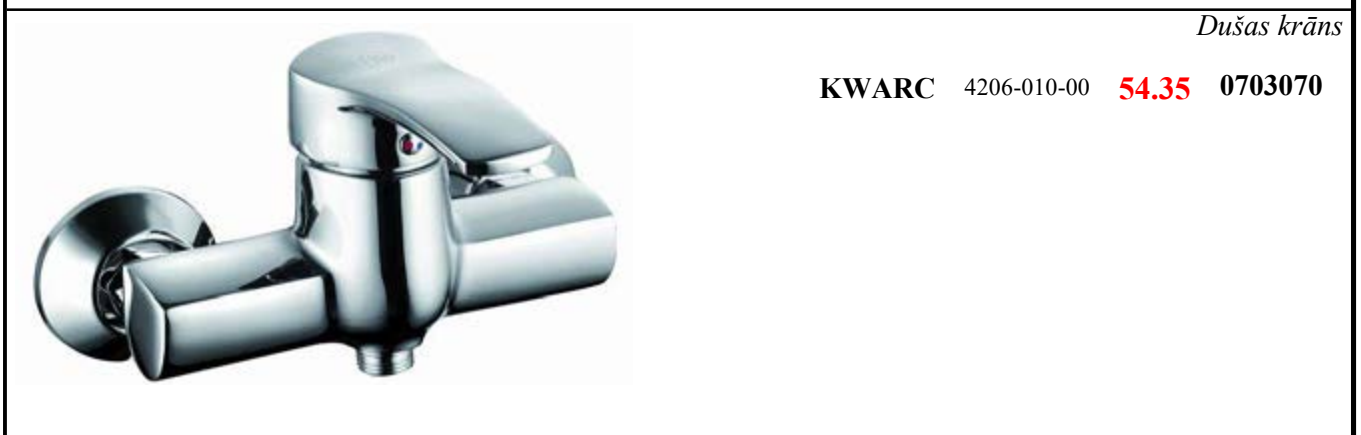
*Dušas krāns*

KWARC 4206-010-00

54.35

0703070

## JAUCĒJKRĀNI AR SVIRAS ROKTURI

**VEIKALS**

	<p style="text-align: right;"><i>Vannas krāns ar dušas komplektu</i></p> <p><b>FS 1135-21</b>                      <b>33.42</b>                      <b>1102031</b></p>
	<p style="text-align: right;"><i>Vannas krāns ar dušas komplektu</i></p> <p><b>FS 1135-300</b>                      <b>40.81</b>                      <b>1102033</b></p>
	<p style="text-align: right;"><i>Virtuves izlietnes krāns</i></p> <p><b>FS 1135-5</b>                      <b>21.39</b>                      <b>1102038</b></p>
	<p style="text-align: right;"><i>Izlietnes krāns (izteka 150 mm)</i></p> <p><b>FS 1135-51</b>                      <b>21.39</b>                      <b>1102039</b></p>
	<p style="text-align: right;"><i>Keramiskās izlietnes krāns</i></p> <p><b>FS 1135-6</b>                      <b>20.69</b>                      <b>1102040</b></p>
	<p style="text-align: right;"><i>Bidē krāns</i></p> <p><b>FS 1135-8</b>                      <b>20.32</b>                      <b>1102042</b></p>
	<p style="text-align: right;"><i>Bidē krāns</i></p> <p><b>FS 1435-8</b>                      <b>10.50</b>                      <b>1102062</b></p> <p style="text-align: center;"><b>IZPĀRDOŠANA</b></p>

## JAUCĒJKRĀNI AR SVIRAS ROKTURI

**VEIKALS**
*Vannas krāns ar dušas komplektu*

**FS 9002-300**    300 mm    **45.52**    **1103031**
*Virtuves izlietnes krāns*

**FS 9002-5**    **22.77**    **1103005**
*Izlietnes krāns (izteka 150 mm)*

**FS 9002-51**    **25.94**    **1103006**
*Izlietnes krāns*

**FS9002-54**    **34.09**    **1103057**
*Bidē krāns*





**FS 9002-8**    **11.00**    **1103008**
**IZPĀRDOŠANA**









## VEIKALS

		<i>Dozators izlietnei, vienam ūdenim</i>		
	<b>215/N</b>	9-15 sec.	<b>EUR 92.22</b>	<b>0508001</b>
		<i>Virsapmetuma caurteces dozators</i>		
	<b>415/SH</b>	9-15 sec.	<b>74.98</b>	<b>0508021</b>
		<i>Dozators pisuāram</i>		
	<b>420/UR</b>	4-6 sec.	<b>62.86</b>	<b>0508004</b>
	<b>420/SH</b>	9-15 sec.	<b>59.01</b>	<b>0508005</b>
		<i>WC dozators</i>		
	<b>310/B 3/4"</b>	4-5 sec.	<b>76.92</b>	<b>0508019</b>
	<b>310/D 1"</b>	4-5 sec.	<b>81.28</b>	<b>0508020</b>
		<i>WC dozators</i>		
	<b>315 1"</b>	9-10 sec.	<b>143.92</b>	<b>0508015</b>

## VEIKALS











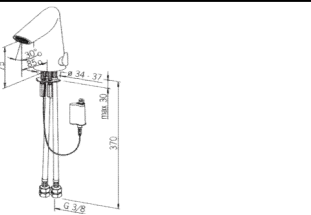

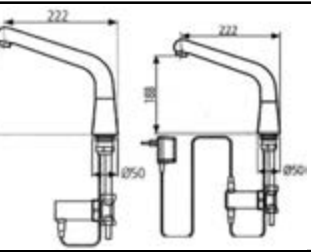
<i>Zemapmetuma dozators pisuāram</i>				
	<b>410/UR</b>	4-6 sec.	<b>80.53</b>	<b>0508016</b>
	<b>410/SH</b>	9-15 sec.	<b>71.93</b>	<b>0508018</b>
<i>Zemapmetuma dozators WC</i>				
	<b>317 1"</b>	4-6 sec.	<b>141.21</b>	<b>0508012</b>
<i>Pisuāra dozators ar trubiņu komplektā</i>				
	<b>TE855</b>	4-6 sec.	<b>57.11</b>	<b>1008001</b>
<i>Zemapmetuma dozators dušai</i>				
	<b>TE30</b>	9-15 sec.	<b>69.09</b>	<b>1008002</b>
<i>Virsapmetuma caurteces dozators dušai</i>				
	<b>TE31</b>	9-15 sec.	<b>60.77</b>	<b>1008003</b>

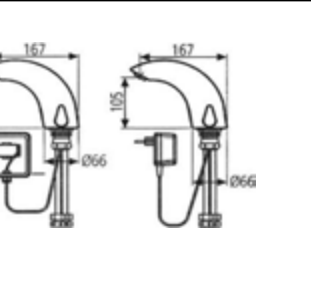
## VEIKALS

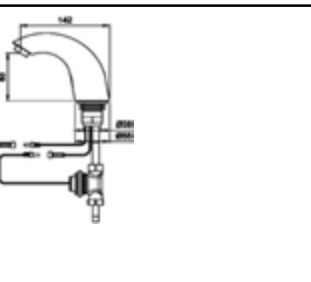
	<b>TB1C</b>				<i>Pievads pīsuāra dozatoram</i> <b>EUR</b> <b>10.48</b>	<b>0510004</b>
	<b>TB2</b>	14x38		<b>4.73</b>		<b>0566001</b>
	<b>330C-B</b> <b>330C-D</b>	3/4"x25 1"x30		<b>33.33</b> <b>36.68</b>		<b>0510008</b> <b>0510007</b>
	<b>332C-B</b> <b>332C-D</b>	3/4"x25 1"x30		<b>25.56</b> <b>26.66</b>		<b>0510012</b> <b>0510011</b>
	<b>215V</b>	4/6 sec.		<b>34.71</b>		<b>0510013</b>
	<b>410 V 4/6</b> <b>410 V 10/15</b>	4/6 sec. 10/15 sec.		<b>40.27</b> <b>40.27</b>		<b>0510002</b> <b>0510014</b>
	<b>310V</b>	4/5 sec		<b>30.02</b>		<b>0510017</b>
	<b>R11</b>			<b>1.83</b>		<b>0510018</b>
	<b>TE VI</b>	4/6 sec.		<b>34.42</b>		<b>1010001</b>
					<i>Paredzēts art: TE15; TE16; TE53; TE255; TE855</i>	
	<b>TE VI30</b>	10/15 sec.		<b>36.09</b>		<b>1010002</b>
					<i>Paredzēts art: TE30 - TE31</i>	

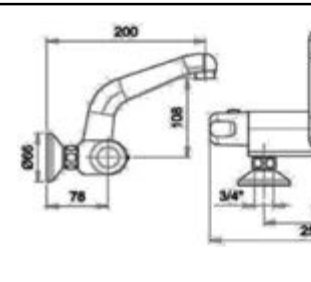

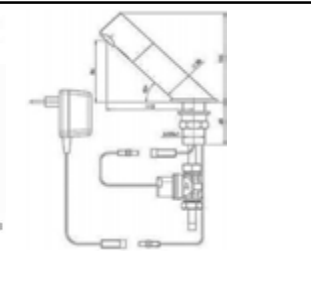

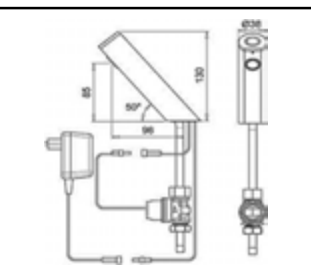

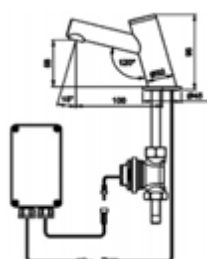

## KRĀNI AR SENSORU

**VEIKALS**  
**EUR**

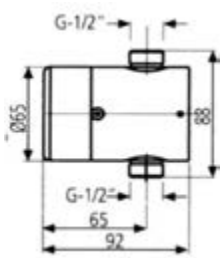

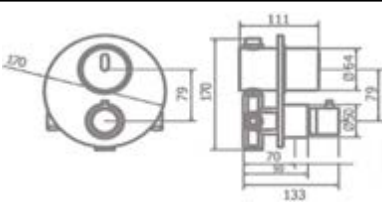

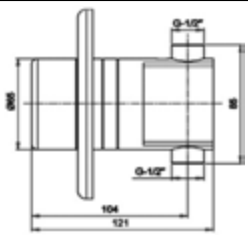

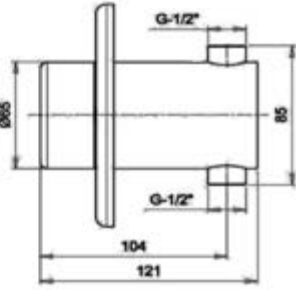









		<p><i>Izlietnes jaucejkrāns ar sensoru</i> (6V baterija montējama pie sienas)</p> <p>ORAS OPTIMA      130103019    <b>218.03</b></p>
		<p><i>Izlietnes krāns ar grozāmu izteku</i> (9V baterija montējama pie sienas)</p> <p>DOLPHIN LB 1040 T      270160    <b>174.85</b>    <b>1508001</b></p>
		<p><i>Izlietnes jaucejkrāns</i> (9V baterija krāna korpusā)</p> <p>SWAN 1000 B      252300    <b>179.99</b>    <b>1508003</b></p>
		<p><i>Izlietnes krāns sagatavotam ūdenim</i> (9V baterija montējama pie sienas)</p> <p>EASY B      246010    <b>146.05</b>    <b>1508011</b></p>
		<p><i>Izlietnes jaucejkrāns ar termostatu</i> (9V baterija krāna korpusā)</p> <p>APOLLO 1000 T      314200    <b>241.70</b>    <b>1508015</b></p>
		<p><i>Izlietnes krāns vienam ūdenim</i></p> <p>TUBULAR      350700    <b>146.05</b>    <b>1508020</b></p>
		<p><i>Izlietnes krāns vienam ūdenim</i></p> <p>TOUCH      225500    <b>120.34</b>    <b>1508021</b></p>















## KRĀNI AR SENSORU

**VEIKALS  
 EUR**

		<p>PERFECT TIME B</p>	<p>220100</p>	<p><b>87.42</b></p>	<p><b>1508014</b></p>
		<p><i>Izlietnes krāns sajauktam ūdenim ar dozātoru</i>                  (9V baterija montējama pie sienas)</p>			
		<p>NEPTUNE 1011 B</p>	<p>610261</p>	<p><b>113.14</b></p>	<p><b>1508005</b></p>
		<p><i>Caurplūdes krāns dušai, sajauktam ūdenim</i>                  (9V baterija krāna korpusā)</p>			
		<p>NEPTUNE 1041 T</p>	<p>612241</p>	<p><b>262.27</b></p>	<p><b>1508019</b></p>
		<p><i>Iebūvējams dušas krāns ar termostatu</i>                  (9V baterija krāna korpusā)</p>			
		<p>PERFECT TIME SH 1031</p>	<p>613700</p>	<p><b>133.71</b></p>	<p><b>1508017</b></p>
		<p><i>Iebūvējams dušas krāns ar dozātoru</i>                  (9V baterija krāna korpusā)</p>			
		<p>NEPTUNE 1031</p>	<p>613200</p>	<p><b>149.14</b></p>	<p><b>1508013</b></p>
		<p><i>Iebūvējams dušas krāns</i>                  (9V baterija krāna korpusā)</p>			
		<p>JUPITER 1031</p>	<p>134510</p>	<p><b>159.42</b></p>	<p><b>1508012</b></p>
		<p><i>Pisuāra krāns</i>                  (9V baterija krāna korpusā)</p>			



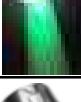









## REZERVES DAĻAS JAUCĒJKRĀNIEM

VEIKALS			
	EUR	Kasetne 35 mm (KLUDI)	
19.61	75 605 00-00	0810040	
	11.19	1130	0110103
Kasetne 35 mm			
	11.19	1140	0110104
7.07	1140 SEDAL	7110085	
Kasetne 35 mm (SEDAL)			
	7.14	1130 SEDAL	7110056
Kasetne 40 mm (SEDAL)			
	9.79	0200 SEDAL	7110057
	14.69	0201	0110107
Kasetne 40 mm			
	14.69	0200	0110121
Kasetne (Kīna)			
	4.40	FC1101/35	1110031
4.40	FC1101/40	1110037	
Kasetne (Kīna)			
	4.40	FC1002/35	1110030
4.40	FC1002/40	1110034	
Kasetne 25 mm			
	12.96	SQ200/15	0110203
Kasetne 35 mm			
	23.94	FC1962/35	7110068
Kasetne 40 mm STSR			
	9.76	ST115	7110081
Krāna ventilis ar divām vītņēm (Itālija)			
	3.57	671 1/2"	0110010
Krāna ventilis (Itālija)			
	3.37	671-E 1/2"	0110086
Krāna ventilis ar keramiskiem diskem			
	8.16	058 1/2"	0110012
3.92	RMG058 1/2"	7110005	
Krāna ventilis			
	2.43	672 3/8"	0110011
0.68	FC2102 3/8"	1110025	

VEIKALS			
	5.74	RMG2053	7110092
Sietiņš krānam ar ārējo vītņi			
	3.97	508 SLC 24x1	2010008
Sietiņš krānam ar iekšējo vītņi			
	3.97	512 SLC 22x1	2010007
Sietiņš krānam ar ārējo vītņi "Coin Slot"			
	2.23	508 NP 24x1	2010006
Sietiņš krānam ar iekšējo vītņi			
	1.07	512 PL 22x1	7110069
512 ECO Sietiņš krānam ar iekšējo vītņi			
	4.32	4.5 l/min 22x1	2110017
4.32	6 l/min 22x1	2110016	
1.23	8 l/min 22x1	2110015	
2.36	10 l/min 22x1	2110014	
Sietiņš krānam ar ārējo vītņi			
	1.07	508 PL 24x1	7110055
508 ECO Sietiņš krānam ar ārējo vītņi			
	4.13	4.5 l/min 24x1	2110011
4.13	6 l/min 24x1	2110010	
4.13	8 l/min 24x1	2110009	
1.23	10 l/min 24x1	2110008	
Sietiņš ar ārējo vītņi			
	2.31	506 (hroms) 28x1	0110141
1.81	508 (hroms) 24x1	0110100	
6.93	506 (zelts) 28x1	0110201	
6.50	508 (zelts) 24x1	0110199	
5.89	508 (13100) 18x1	0110185	
Sietiņš ar iekšējo vītņi			
	1.77	512 (hroms) 22x1	0110101
5.97	512 (zelts) 22x1	0110200	
5.38	512 (13600) 20x1	0110186	
7.34	512 (13700) 16x1	0110190	
Sietiņš bidē krānam			
	7.51	510 (hroms)	0110131
16.23	510 (zelts)	0110136	
12.52	510 (futurist) 18x1	0110187	
Sietiņš krānam ar LED apgaismojumu			
	6.05	FX508 LED	4810016
IZPĀRDOŠANA			
	505	Pretvārsts krānam	
3.44	7110015		
507 ECO Ūdens plūsmas reduktors			
	6.54	6 l/min	2110007
2.06	8 l/min	2110020	

## REZERVES DAĻAS JAUCĒJKRĀNIEM

VEIKALS EUR

	<i>Krāna uzgalis ar diviem režīmiem</i>	03630 NEW 15 cm	5.45	2010005
	<i>Krāna uzgalis ar diviem režīmiem</i>	03630 Universāls	3.02	2010003
	<i>Rokturis krānam ABS</i>	672/10	1.86	0110013
	<i>Rokturis krānam ORCHIDEA</i>	672/30	3.06	0110015
	<i>Rokturis krānam TRICORNO</i>	672/40	3.19	0110016
	<i>Rokturis krānam LIBERTY</i>	050	2.88	0110033
	<i>Uzlika ventilim</i>	052	1.13	0110034
	<i>Rokturis krānam APALŠ (MAGMA)</i>	RMG10	4.23	7110003
	<i>Rokturis krānam KRUSTA (Ķīna)</i>	FDH0039	1.35	1110021
	<i>Rokturis krānam KRUSTA (MAGMA)</i>	RMG11	4.87	7110009
	<i>Rokturis krānam JUPITS</i>	MG 035 40 mm	7.80	7110053
	<i>Rokturis krānam PANTHER</i>	1100 hroms	9.96	0110102





VEIKALS EUR

	<i>Rokturis krānam RING</i>	1108	9.96	0110111
	<i>Rokturis krānam LG</i>	MGMED 40 mm	10.29	7110071
	<i>Rokturis krānam VENERA</i>	MG64 35 mm	3.86	7110073
	<i>Rokturis krānam SATO</i>	MG 008 35 mm	5.62	7110049
	<i>Rokturis krānam URANS</i>	MG 049 35 mm	5.62	7110050
	<i>Rokturis krānam URANS</i>	MG 049 40 mm	7.80	7110054
	<i>Stiprinājuma uzgrieznis</i>	MGREZ VĪTNE	1.42	7110100
	<i>Stiprinājuma komplekts izlietnes krānam ar caurplūdi</i>	FXP0093	13.00	1110043
	<i>Stiprinājuma komplekts izlietnes krānam</i>	FXP0092	4.54	7110014
	<i>Stiprinājuma komplekts izlietnes krānam</i>	0114/A	3.36	0110035
	<i>Stiprinājuma komplekts izlietnes krānam (5E)</i>	0115/A 70 mm	6.93	0110159
		0116/A 110 mm	5.78	0110165
	<i>Stiprinājuma komplekts izlietnes krānam</i>	FXP0090	1.59	1110024
	<i>Stiprinājuma komplekts izlietnes krānam</i>	FXP0091	1.59	1110011

## REZERVES DAĻAS JAUCĒJKRĀNIEM

## VEIKALS

## VEIKALS

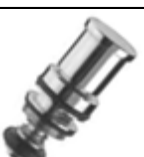
<i>Ekscentru uzgriežņi komplektā</i>			
	Labais R10251	EUR 6.60	0110155
	Kreisais MG R10251	EUR 4.10	7110065
<i>Uzgrieznis</i>			
	R11851	EUR 7.95	0110181
<i>Dekoratīvais riņķis 62 sērijas jaucējkrāniem</i>			
	RMG62	EUR 0.94	7110016
<i>Pārslēdzējs vannas krānam</i>			
	0518/A (met)	EUR 5.11	0110054
<i>Pārslēdzēja komplekts krānam MG2134</i>			
	REZMG213	EUR 9.85	7110045
<i>Pārslēdzēja mehānisms vannas krānam</i>			
	0519	EUR 4.38	0110048
<i>Pārslēdzēja mehānisms vannas krānam</i>			
	0520	EUR 2.46	0110074
<i>Pārslēdzēja mehānisms</i>			
	1050-MEH	EUR 17.16	0110137
<i>Pārslēdzēja mehānisms</i>			
	1050-MEH F	EUR 7.07	1110040
<i>Pārslēdzēja mehānisms</i>			
	1064-MEH	EUR 8.46	0110158
<i>Pārslēdzēja mehānisms Futurist sērijai</i>			
	13001	EUR 11.48	0110195
<i>Ekscentri (komplekts vienam krānam)</i>			
	655/40 (HR)	EUR 4.54	0110060
	655/40 (mat)	EUR 4.99	0110170







<i>Ekscentri (komplekts vienam krānam)</i>			
	655/50	EUR 5.03	0110032
<i>Ekscentri (komplekts vienam krānam)</i>			
	655/60	EUR 6.42	7110007
	komplekta svars: 181 gr		
	655/92	EUR 10.33	7110046
	komplekta svars: 261 gr		
<i>Ekscentri uz vannas</i>			
	FTP0052	EUR 34.31	1110036
<i>Ekscentri garie (60 mm)</i>			
	655/55	EUR 25.84	0110076
<i>Dušas stienis (stacionārais)</i>			
	590	EUR 12.38	0110001
			Garums 115 cm
<i>Sietiņš stacionārajam dušas stienim</i>			
	740	EUR 2.56	0110049
<i>Pretvārsts krānam</i>			
	505	EUR 2.71	7110015
<i>Sienas stiprinājuma pagarinājums 2090/2095 garums 7 CM vecajam modelim</i>			
	REZMG2295	EUR 4.17	7110102
<i>Dušas stieņa FX250, apakšējā daļa garums 100 CM vecajam modelim</i>			
	FX250	EUR 28.27	4830014



















## REZERVES DAĻAS JAUCĒJKRĀNIEM

### VEIKALS

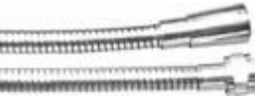
### VEIKALS

RMG2056/D		<i>Duša jaucējkrānam MG2056</i>	
	<b>15.00</b>	<b>4839048</b>	
RMG2057/D		<i>Duša jaucējkrānam MG2057</i>	
	<b>13.00</b>	<b>4839049</b>	
655/J		<i>Izteka izlietnes krānam</i>	
	<b>EUR</b>		
	14x140	<b>5.33</b>	<b>0110045</b>
	14x162	<b>7.19</b>	<b>0110061</b>
	18x150	<b>6.12</b>	<b>0110004</b>
	18x200	<b>7.66</b>	<b>0110005</b>
<b>RMG061</b>	18x150	<b>7.42</b>	<b>7110008</b>
655/S		<i>Izteka "S" veida</i>	
	14x160	<b>5.59</b>	<b>0110044</b>
	18x200	<b>6.12</b>	<b>0110006</b>
	18x300	<b>12.58</b>	<b>0110007</b>
		<i>Izteka "S" veida</i>	
<b>RMG060 F (18x300)</b>		<b>5.62</b>	<b>1110009</b>
			
655/U		<i>Izteka "U" veida</i>	
	18x200	<b>6.12</b>	<b>0110008</b>
075		<i>Izteka "S" veida, liekta</i>	
	200 mm	<b>26.88</b>	<b>0110123</b>
	200 F	<b>8.63</b>	<b>1110033</b>
	300 F	<b>12.22</b>	<b>1110032</b>
	200 NT	<b>5.45</b>	<b>7110079</b>
	300 NT	<b>5.68</b>	<b>7110078</b>

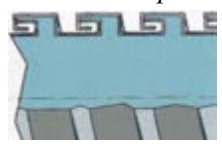









068		<i>Izteka "S" veida, plakana</i>	
	150 mm	<b>16.63</b>	<b>0110132</b>
	200 mm	<b>21.48</b>	<b>0110097</b>
	300 mm	<b>23.64</b>	<b>0110098</b>
	200 F	<b>8.63</b>	<b>1110027</b>
	300 F	<b>12.23</b>	<b>1110028</b>
	200 NT	<b>5.45</b>	<b>7110076</b>
	300 NT	<b>5.68</b>	<b>7110077</b>
	350 NT	<b>7.81</b>	<b>7110091</b>
055		<i>Izteka jaucējkrānam 3255, 6255</i>	
	HROMS 233x165xØ24	<b>10.88</b>	<b>7110067</b>
<b>RMG02555 IZT</b>		<i>Izteka jaucējkrānam MG2555</i>	
	HROMS 210x180xØ24	<b>14.69</b>	<b>7110090</b>
070		<i>Izteka izlietnes krānam</i>	
	MATĒTS 180x130xØ25	<b>9.99</b>	<b>0110189</b>
404/C		<i>Izteka no izlietnes (apaļa)</i>	
		<b>18.77</b>	<b>0510003</b>









	<p>01001 (200) BL <i>Dubultais pinums ar konusu, hromēts</i></p> <p>01001 (200) <i>Dubultais pinums ar konusu, hromēts</i></p> <p>01001 (150) BL <i>Dubultais pinums ar konusu, ar vienu metrisko vītņi, hromēts</i></p>	<p>FLEXTON, ITĀLIJA</p> <p>6.80 0410040</p> <p>8.50 0410005</p> <p>5.40 0410038</p>
	<p>01001 (150) <i>Dubultā pinuma ar konusu, 1/2"x3/8"IV, hromēts</i></p> <p>01001 (200) <i>Dubultā pinuma ar konusu, 1/2"x3/8"IV, hromēts</i></p>	<p>FLEXTON, ITĀLIJA</p> <p>28.20 0410021</p> <p>34.10 0410022</p>
	<p>01003 (150) <i>Dubultā pinuma virtuves krānam, 1/2"x3/8"ĀV, hromēts</i></p> <p>01003 (200) <i>Dubultā pinuma virtuves krānam, 1/2"x3/8"ĀV, hromēts</i></p>	<p>FLEXTON, ITĀLIJA</p> <p>18.07 0410018</p> <p>26.73 0410019</p>
	<p>01006 (200) <i>Dubultā pinuma, hromēts</i></p>	<p>FLEXTON, ITĀLIJA</p> <p>6.20 0410012</p>
	<p>01010 (200) <i>Vienkāršais pinums ar konusu, hromēts</i></p>	<p>FLEXTON, ITĀLIJA</p> <p>6.10 0410015</p>
	<p>1014 (150) <i>Vienkāršais pinums, hromēts</i></p> <p>01014 (150) BL <i>Vienkāršais pinums ar vienu metrisko vītņi, hromēts</i></p> <p>1014 (150) <i>Vienkāršais pinums ar divām metriskām vītņēm, hromēts</i></p> <p>01014 (150) BL <i>Vienkāršais pinums ar divām metriskām vītņēm, hromēts</i></p> <p>01014 (200) <i>Vienkāršais pinums, hromēts</i></p>	<p>FLEXTON, ITĀLIJA</p> <p>4.00 0410013</p> <p>3.90 0410036</p> <p>3.70 0410011</p> <p>4.10 0410035</p> <p>5.80 0410016</p>
	<p>6105505-00 (125) <i>Plastikāta, ar diviem konusiem, "Logoflex"</i></p> <p>6105605-00 (160) <i>Plastikāta, ar diviem konusiem, "Logoflex"</i></p> <p>6105705-00 (200) <i>Plastikāta, ar diviem konusiem, "Logoflex"</i></p>	<p>KLUDI, VĀCIJA</p> <p>14.64 0810010</p> <p>9.48 0810001</p> <p>11.29 0810013</p>
	<p>0407420 (160-200) <i>Dubultā pinuma ar grozāmu konusu, elastīgs, hromēts</i></p>	<p>NICOLL, FRANCIJA</p> <p>40.90 1210002</p>
	<p>108 (150) <i>Vienkāršais pinums, hromēts</i></p>	<p>FLORY, ĶĪNA</p> <p>3.47 1110004</p>
	<p>710/10 (150) <i>PVC balts</i></p>	<p>FLEXTON, ITĀLIJA</p> <p>5.72 0110077</p>
<p>"BL" iepakojums ar kartona maliņu</p> 	<p>Dubultais pinums</p> 	<p>Vienkāršais pinums</p> 

		VEIKALS				VEIKALS	
	00010	EUR	<i>Bigmama</i> D11 cm	Hroms	23.80	0439070	
	00053		<i>Twister Happy</i> D6 cm	Hroms	9.99	0439021	
	00054		<i>Twister - 3</i> D6 cm	Hroms	13.48	0439022	
	00098		<i>Cobra - 1 Big</i> D6.5 cm	Hroms	9.99	0439004	
	003L2CR		<i>OAK</i>	Hroms	22.35	0439060	
	00511	EUR	<i>Liberty</i> D7 cm	Balts/hroms	36.72	0439085	
	RU1070		D2.5 cm	Hroms	5.49	0139030	
	D.5.10		<i>Frizieru</i> D2.5 cm	Hroms	24.06	0139035	
	00S29		<i>NORMALE</i> D6.2 cm	Hroms	11.39	0439086	
	00H59		<i>NORMALE</i> D20 cm	Hroms	244.44	0439033	
	00H91		<i>LIBERTY</i> D20 cm	Hroms	133.11	0439054	
	00H99		<i>LIBERTY</i> D30 cm	Hroms	256.41	0439051	
	00H74		<i>PRISMA PIU</i> D20 cm	Hroms	35.57	0439052	
	740		D9 cm	Hroms	3.40	0110049	

## VEIKALS

## VEIKALS

	Dušas galva (misina), kvadrāts FX19139 19 cm	<b>36.55</b>	<b>1139018</b>
	Kronšteins dušas galvai 8200 20 cm	<b>29.27</b>	<b>0439046</b>
	Kronšteins dušas galvai 90000 20 cm	<b>21.54</b>	<b>0439047</b>
	Kronšteins dušas galvai FX94000 15 cm	<b>17.02</b>	<b>4839042</b>
	Kronšteins dušas galvai 9F000 30 cm	<b>70.47</b>	<b>0439058</b>
	Kronšteins dušas galvai (vertikālais) 73000 30 cm	<b>119.37</b>	<b>0430099</b>
	Kronšteins dušas galvai 7G000 30 cm 35 cm 40 cm	<b>42.46</b> <b>45.90</b> <b>48.20</b>	<b>0439083</b> <b>0439084</b> <b>0439048</b>
	Kronšteins dušas galvai, vertikālais (40 cm) 9G000 20 cm 30 cm	<b>54.36</b> <b>58.52</b>	<b>0439066</b> <b>0439059</b>
	2580 Dušas stiprinājums plastmasa HROMS	<b>4.05</b>	<b>0139007</b>
	F4000 Dušas stiprinājums ar caurplūdi misiņš HROMS	<b>13.55</b>	<b>0439044</b>

	A8000 Dušas turētājs misiņš	<b>5.28</b>	<b>0439016</b>
	F5000 Dušas izvads ar klausules turētāju misiņš 1/2"x1/2"	<b>24.06</b>	<b>0439049</b>
	F7000 Dušas izvads ar klausules turētāju misiņš 1/2"x1/2"	<b>45.18</b>	<b>0439080</b>
	6054705-00 Dušas izvads ar klausules turētāju misiņš 1/2"x1/2"	<b>22.57</b>	<b>0839034</b>
	02028 Izvads dušas klausulei, 30° misiņš 1/2"x1/2"	<b>6.32</b>	<b>0439075</b>
	MG589 Dušas pārslēdzējs	<b>9.92</b>	<b>7110004</b>
	MG589-MEH Mehānisms pārslēdzējam MG-589	<b>3.16</b>	<b>7110075</b>
	589F Dušas pārslēdzējs	<b>5.78</b>	<b>1110007</b>
	823-122-00 Dušas pārslēdzējs	<b>8.99</b>	<b>0710006</b>

 <p><i>Dušas komplekts "ZENTA" DUAL SHOWER</i> KLUDI</p> <p>6167705-00 <b>520.46</b> 0830035</p> <p>Augšas galva D20 cm Rokas duša D8.4 cm Dušas pievads 150 cm Pievads jaucējkrānam 80 cm Stienis 130 cm Starp centriem 75 cm</p>	<p><i>Dušas stienis komplektā ar ziepju turētāju</i></p> <p>15000 <b>19.00</b> 0430009</p> <p>Stienis plakans 60 cm</p> 
 <p><i>Dušas komplekts "ZENTA"</i> KLUDI</p> <p>6063005-00 <b>80.74</b> 0830031</p> <p>Rokas duša D8.4 cm Dušas pievads 150 cm Stienis 60cm</p>	
 <p><i>Dušas stienis ar pievadu "A-QA" 90 CM</i></p> <p>6572005-00 <b>88.07</b> 0830038</p> <p>Dušas pievads 150 cm Stienis 90 cm</p>	
 <p><i>Dušas stienis</i></p> <p>12000 <b>19.99</b> 0430002</p> <p>Stienis plakans 60 cm</p>	

VEIKALS

VEIKALS

Dušas komplekts "Bali" Ø18-Twister happy  
Hroms/zelts



32053 **36.00** 0430086

Rokas duša D6 cm  
Dušas pievads 150 cm  
Stienis 60 cm

**IZPĀRDOŠANA  
VAIRUMCENA**

Dušas komplekts "Onda reflex" Ø25-Space age 80 cm



2B043 **48.00** 0430088

Rokas duša D6 cm  
Dušas pievads 150 cm  
Stienis 80 cm  
Starp centriem 15.5 cm

**IZPĀRDOŠANA  
VAIRUMCENA**

Dušas komplekts "Hawaii" Ø25-PASCAL



**EUR**  
26239B10 **15.00** 0430067

Dušas pievads 150 cm  
Stienis 60 cm

**IZPĀRDOŠANA  
VAIRUMCENA**

Dušas komplekts "Hawaii" Ø25-BIMBO



26225B30 **20.00** 0430066



Dušas pievads 150 cm  
Stienis 60 cm

**IZPĀRDOŠANA  
VAIRUMCENA**

## Izlietnes sifoni

VEIKALS

EUR

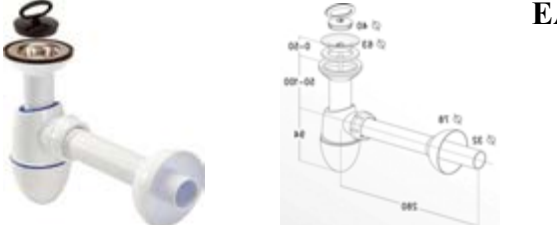
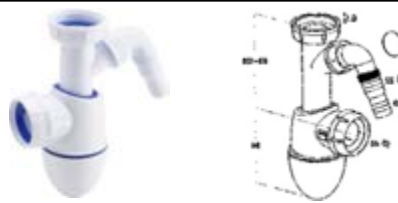
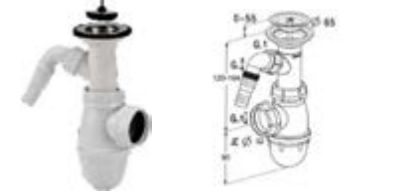
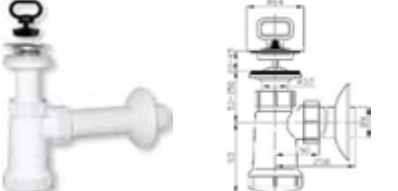
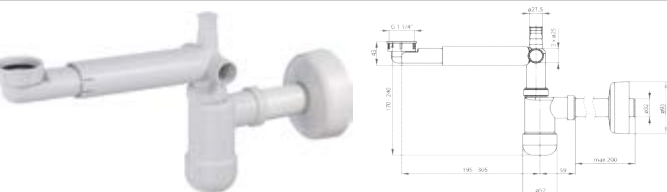
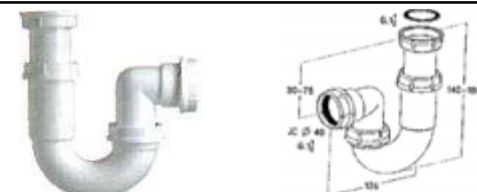
		<i>Izlietnes sifons</i>		
	1,1/4"x32	0201284	<b>4.20</b>	<b>1250049</b>
	1,1/4"x40	0201285	<b>4.20</b>	<b>1250050</b>
	1,1/2"x40	0224287	<b>4.12</b>	<b>1250052</b>
		<i>Izlietnes sifons</i>		
	1,1/4"x32	0201270	<b>3.08</b>	<b>1250001</b>
	1,1/2"x40	0224193	<b>3.18</b>	<b>1250010</b>
	1,1/4"x32x65	0201247	<b>8.37</b>	<b>1250058</b>
		<i>Izlietnes sifons</i>		
	1,1/4"x32	0202014	<b>5.94</b>	<b>1250002</b>
	1,1/2"x40	0202075	<b>7.27</b>	<b>1250019</b>
<b>EASYPHON</b>		<i>Izlietnes sifons ar noteci</i>		
	1,1/4"x32	0202122	<b>10.22</b>	<b>1250025</b>
	1,1/4"x40	0202138	<b>10.24</b>	<b>1250015</b>
	1,1/2"x40	0224217	<b>10.58</b>	<b>1250040</b>
		<i>Izlietnes sifons ar veļas mašīnas pieslēgumu</i>		
	1,1/4"x1,1/4"	0201302	<b>5.97</b>	<b>1250044</b>
	1,1/4"x1,1/2"	0201303	<b>5.98</b>	<b>1250045</b>
	1,1/2"x1,1/2"	0224360	<b>6.42</b>	<b>1250016</b>
		<i>Izlietnes sifons ar veļas mašīnas pieslēgumu un noteci</i>		
	1,1/2"x65	0202071	<b>9.93</b>	<b>1250046</b>
		<i>Izlietnes sifons ar noteci</i>		
	1,1/4"x32	EU0N332	<b>4.86</b>	<b>6850043</b>
	1,1/4"x40	EU0N342	<b>4.86</b>	<b>6850044</b>
		<i>Sifons izlietnei bez noteces ar nobīdi (teleskopisku)</i>		
	1 1/4x32	NHC_633K	<b>21.00</b>	<b>8240005</b>
		<i>Izlietnes sifons</i>		
	1,1/2"x40	0204460	<b>5.77</b>	<b>1250030</b>

Sifoni









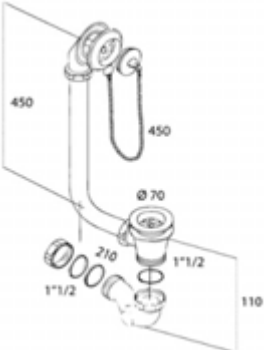

VEIKALS  
EUR

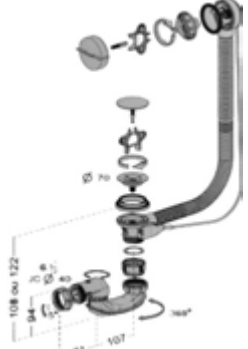
		<i>Savienojums dubultai izlietnei ar veļas mašīnas pieslēgumu</i>	1,1/2"x40	0204981	<b>7.91</b>	<b>1250012</b>
		<i>Komplekts sifona pievienošanai ar nobīdi</i>	1,1/4"x1/4"	0201011	<b>7.67</b>	<b>1250062</b>
		<i>Komplekts sifona pievienošanai ar nobīdi</i>	1,1/2"x1/1/2"	0204183	<b>6.41</b>	<b>1250061</b>
		<i>Pārplūde metāla izlietnei</i>	1,1/2"x70	0204015	<b>8.37</b>	<b>1250017</b>
			1,1/2"x114	0204123	<b>16.52</b>	<b>1250055</b>
		<i>Pārplūde metāla izlietnei Ø115</i>	1,1/2"x115	EDVA130	<b>15.35</b>	<b>1250042</b>
		<i>Pārplūde keramiskai izlietnei</i>	1,1/4'	0201152	<b>9.11</b>	<b>1250043</b>
		<i>Pārplūde metāla izlietnei Ø114, universāla</i>	1,1/2"x114	0224506/1	<b>26.05</b>	<b>1250068</b>
		<i>Izlietnes sifons ar pārplūdi Ø70</i>	1,1/2"x70	0204315	<b>11.49</b>	<b>1250018</b>
		<i>Dubultās izlietnes sifons ar veļas mašīnas pieslēgu</i>	1,1/2"x50	33 120 ED70440	<b>23.76</b>	<b>6850013</b>
		<i>Izlietnes sifons</i>	1,1/2"x50	31 206 EM26451	<b>6.83</b>	<b>6850014</b>
		<i>Izlietnes sifons ar noteci</i>	1,1/2"x40/50x70	ED20451	<b>9.71</b>	<b>6850005</b>
		<i>Izlietnes sifons ar veļas mašīnas pieslēgu</i>	1,1/2"x40/50	31 209 EM36451	<b>8.09</b>	<b>6850004</b>
		<i>Izlietnes sifons ar veļas mašīnas pieslēgu un noteci</i>	1,1/2"x40/50x70	ED30451	<b>9.77</b>	<b>6850009</b>

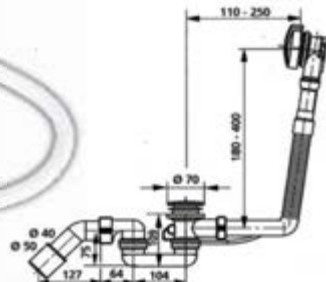

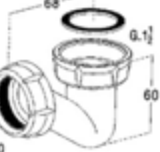
## Sifoni vannām

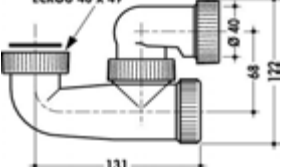
VEIKALS  
 EUR

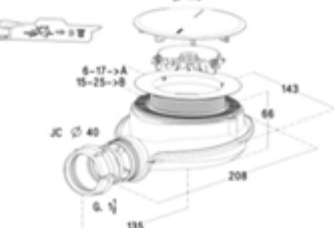
		<p><i>Sifons vannai ar ķēdi (hromēts)</i></p> <p>1,1/2"x40</p>	<p>0505040    <b>164.13</b>    <b>1240004</b></p>
		<p><i>Sifons vannai, automātiskais "EASYBAIN"</i></p> <p>1,1/2"x40x70</p>	<p>0203617    <b>37.10</b>    <b>1250056</b></p> <p><i>Troses garums 100 cm</i></p> <p>1,1/2"x40/50    0203618    <b>49.73</b>    <b>1250011</b></p>
		<p><i>Sifons vannai</i></p> <p>1,1/2"x40/50</p>	<p>0203562    <b>12.63</b>    <b>1250014</b></p>
		<p><i>Traps vannas sifonam ar izplūdes cauruli</i></p> <p>1,1/2"x40/50</p>	<p>0203059    <b>8.61</b>    <b>1250032</b></p>
		<p><i>Sifons dušvannai (īsais)</i></p> <p>1,1/2"x11/2"</p>	<p>0203011    <b>4.51</b>    <b>1250060</b></p>
		<p><i>Sifons ar revīziju</i></p> <p>1,1/2"x11/2"</p>	<p>0203008    <b>8.60</b>    <b>1250013</b></p>
		<p><i>Sifons dušvannai (magnētiskais)</i></p> <p>1,1/2"x40</p>	<p>0205800    <b>37.65</b>    <b>1250066</b></p>

## Sifoni dušvannām











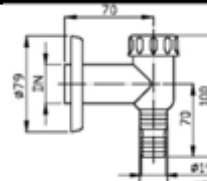

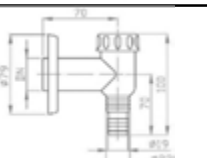

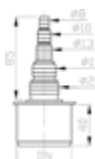

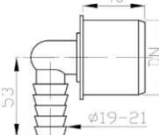

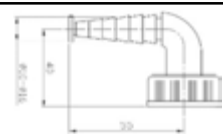

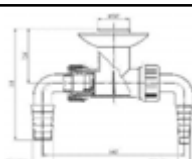
VEIKALS

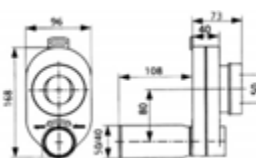
EUR

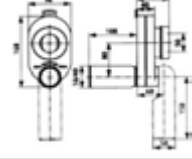
	<i>Sifons dušvannai ar dekoratīvo korķi Ø90</i>	1,1/2"x40/50	0205703	<b>49.91</b>	<b>1250039</b>
	<i>Sifons dušvannai ar korķi Ø70</i>	1,1/2"x40/50	0205374	<b>11.07</b>	<b>1250034</b>
	<i>Sifons dušvannai ar automātisko korķi "Cloc-Clic"</i>	1,1/2"x40/50	0205458	<b>49.48</b>	<b>1250051</b>
	<i>Sifons dušvannai ar dekoratīvo korķi ar hromētu ABS korķi Ø112</i>	Ø90x40/50	0205240	<b>31.10</b>	<b>1250008</b>
	<i>Sifons dušvannai ar dekoratīvo korķi Ø74</i>	Ø50-60x40/50	0205376	<b>22.61</b>	<b>1250027</b>
	<i>Sifons dušvannai ar dekoratīvo korķi ar hromētu ABS korķi Ø90</i>	Ø60x1,1/2"	0205301	<b>11.51</b>	<b>1250033</b>
	<i>Sifons dušvannai ar dekoratīvo korķi ar hromētu ABS korķi Ø120</i>	Ø90x1,1/2"	EWC0850	<b>18.66</b>	<b>6850007</b>
	<i>Sifons dušas paliktnim, zemaīs</i>	90/40	EWCN942	<b>29.50</b>	<b>6850041</b>
	<i>Sifons dušavannai</i>		SIBH208	<b>13.09</b>	<b>1250064</b>

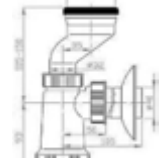
## Sifoni

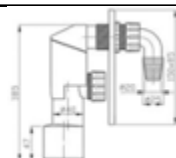
VEIKALS  
EUR

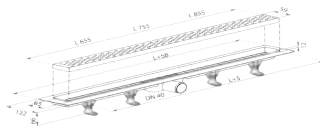
						<i>Sifons veļas mašīnai</i>
		EPVN000	6.90	6850006		
						<i>Sifons veļas mašīnai</i>
		EPVP000	3.82	6850022		
		DN50	8-25mm	UZ50000	4.72	6850028
		DN50	19-21mm	UZ50R00	4.72	6850029
						<i>Veļasmašīnas līkums</i>
		10-16 mm	EPP1230	1.46	6850030	
		18-23 mm	EPP1200	1.46	6850031	
		DN32	10-16/18-23	EPT3300	9.72	6850039
		DN32	18-23 mm	EPT3200	9.72	6850038
		DN50/40	31 407	ESO0550	23.21	6850002
		DN50/40	31 405	ESO0551	23.21	6850001
		DN40		ESO0341	9.64	6850042
		3/4"-1"x40/50	31 603	EPPC450	6.94	6850003
		SZA5650	655 mm	102.79	6850021	<i>Grīdas ūdens noteka (ner. tērauds)</i>
		SZE2850	855 mm	117.97	6850020	

### Izlietnes sifoni

*Sifons izlietnei "KLUDI"*

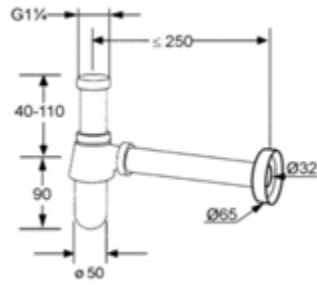
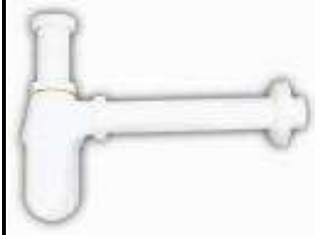

1,1/4"x32	HROMS	1010505-00	<b>25.52</b>	<b>0840017</b>
1,1/4"x32	BALTS	1010536-00	<b>39.22</b>	<b>0840002</b>

*Sifons izlietnei ar nobīdi*

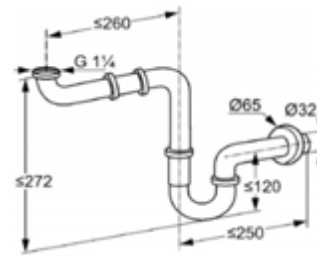

1,1/4"x32		1025505-00	<b>46.69</b>	<b>0840018</b>
-----------	--	------------	--------------	----------------

*Sifons izlietnei "KLUDI"*

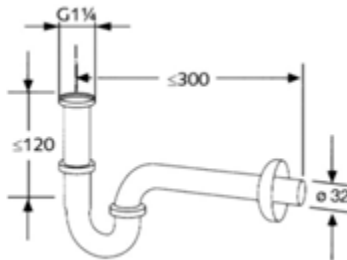

1,1/4"x32		1026505-00	<b>26.32</b>	<b>0840016</b>
-----------	--	------------	--------------	----------------

*Sifons bidē "KLUDI"*

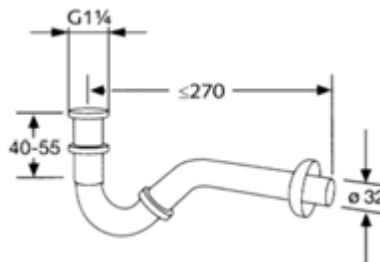

1,1/4"x32		1031105-00	<b>26.21</b>	<b>0840014</b>
-----------	--	------------	--------------	----------------

*Sifons izlietnei*

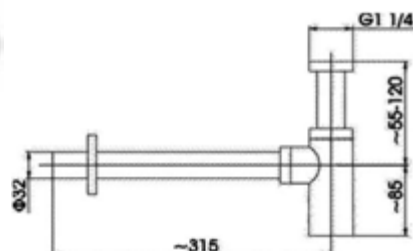

1,1/4"X32	MISIŅŠ	600-004	<b>27.54</b>	<b>7140001</b>
-----------	--------	---------	--------------	----------------

## Izlietnes sifoni

VEIKALS  
 EUR

*Sifons izlietnei*

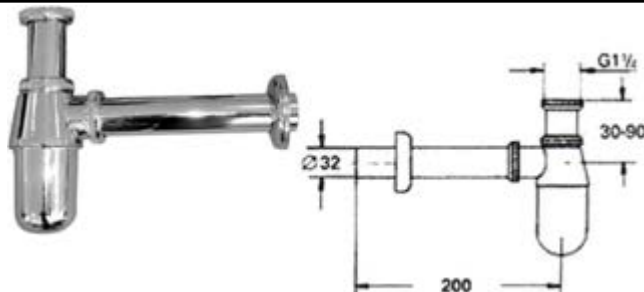
	1,1/4"x32	Cinks/alu	110Z	<b>14.26</b>	<b>0340006</b>
---	-----------	-----------	------	--------------	----------------

*Sifons izlietnei ar noteci*

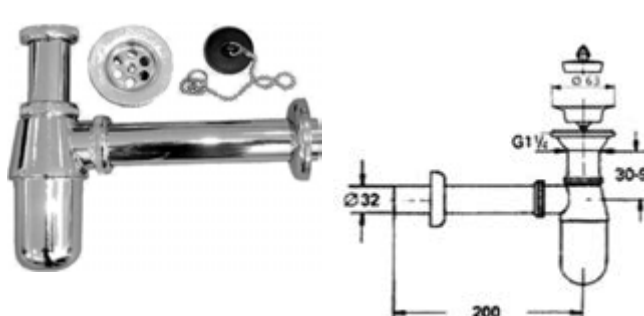
	1,1/4"x32	Cinks/alu	112Z	<b>16.01</b>	<b>0340000</b>
---	-----------	-----------	------	--------------	----------------

*Sifons bidē*

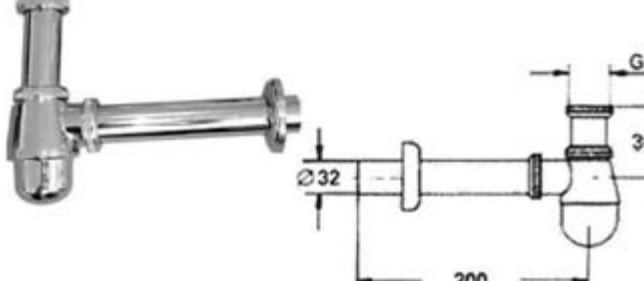
	1,1/4"x32	Misiņš	120	<b>20.66</b>	<b>0340009</b>
--	-----------	--------	-----	--------------	----------------

*Sifons bidē ar noteci*

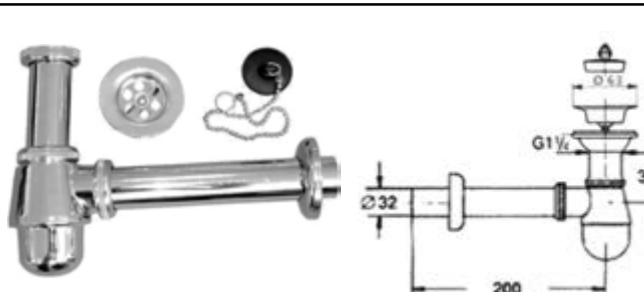
	1,1/4"x32	Misiņš	122	<b>22.86</b>	<b>0340010</b>
---	-----------	--------	-----	--------------	----------------

*Sifons izlietnei bez noteces*

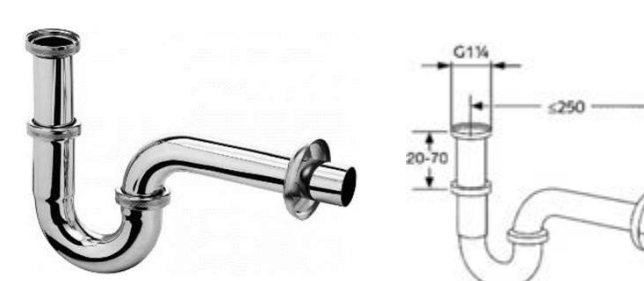
	1,1/4"x32	Misiņš	1025005-00	<b>16.48</b>	<b>0840015</b>
---	-----------	--------	------------	--------------	----------------

*Starplika notecei*

	0403069			<b>18.20</b>	<b>1245006</b>
---	---------	--	--	--------------	----------------

VEIKALS  
EUR

VEIKALS  
EUR

 <p>SFH10INCEX <b>99.86</b> 1250067</p> 	<p><i>Traps grīdai ar hidroizolāciju</i></p> <p>Traps grīdai ar horizontālu izplūdi</p> <p>150x150/110 61 <b>10.74</b> 7850002</p>
 <p>00x100x50 SIHJ10I <b>12.48</b> 1250037</p>	<p><i>Traps grīdai ar vertikālu izplūdi</i></p> <p>Traps grīdai ar vertikālu izplūdi 92604/46</p> <p>120x120/50 <b>24.87</b> 1750007</p>
 <p>100x100x50 831 <b>4.34</b> 1750001</p>	<p><i>Traps grīdai ar horizontālu izplūdi</i></p> <p>Traps grīdai ar horizontālu izplūdi 92604/47</p> <p>120x120/50 <b>26.53</b> 1750006</p>
 <p>100x100x50 830 <b>4.06</b> 0350010 150x150x50 830 <b>4.96</b> 0350011</p>	<p><i>Sausais traps ar horizontālu izplūdi</i></p> <p>100x100/50 SI50C01 <b>14.99</b> 6850018</p>
 <p>100x100x1,1/4 917 <b>26.42</b> 0140005</p>	<p><i>Sausais traps ar vertikālu izplūdi</i></p> <p>100x100/50 SI5PC01 <b>14.99</b> 6850019</p>
 <p>1,1/2" 907 <b>7.20</b> 0140003</p>	<p><i>Universālais traps ar horizontālu izplūdi</i></p> <p>100x100/50 SI50C01UNI <b>19.72</b> 6850023</p>
 <p>150x150/110 832 <b>18.32</b> 1750003</p>	<p><i>Lietus ūdens uztvērējs</i></p> <p>DN110 9200 <b>11.00</b> 1767003</p>
 <p>150x150/110 832 <b>18.24</b> 1750004</p>	<p><i>Ūdens novadīšanas kanāls</i> 1000mm x 130 mm</p> <p>99101 <b>23.80</b> 1767004</p> 
 <p>150x150/110 60 <b>8.03</b> 7850001</p>	<p><i>Izvads kanālam</i></p> <p>99102 <b>6.33</b> 1767005</p>
	<p><i>Gala noslēgs kanālam</i></p> <p>99103 <b>6.29</b> 1767006</p>
	<p><i>Trapu reste, nerūs.tērauds.</i></p> <p>NSI50C0 100x100 mm <b>4.90</b> 6850036 NSIA0C0 150x150 mm <b>12.15</b> 6850037</p> 

## Noteces

**VEIKALS**

	<i>Notece "Cloc-clic", universāla, derīga ar un bez pārplūdes</i>				
	<b>MELNA</b>	1,1/4"x65x50(max) 1,1/4"x65x50(max)	1250UNIVE 1250NERA01	<b>EUR</b> 15.27 20.83	<b>0745001</b> <b>7445005</b>
	<i>Notece "Cloc-clic", ar pārplūdi</i>				
		1,1/4"x65x60(max)	600-352	18.43	<b>1445001</b>
	<i>Misiņa notece, zemā</i>				
		1,1/4"x65x15 1,1/2"x80x15	201 201	4.99 4.11	<b>0345000</b> <b>7445001</b>
	<i>Misiņa notece, augstā ar pārplūdi</i>				
		1,1/4"x63x50(max)	1042705-00	16.65	<b>0845003</b>
	<i>Misiņa notece, augstā bez pārplūdes</i>				
		1,1/4"x64x(29-50) 1,1/4"x64x(8-22)	1042105-00 1042205-00	27.60 114.24	<b>0845002</b> <b>0845004</b>
	<i>Notece krānam</i>				
		1,1/4"x63 1,1/4"x63	655/95 655/95 zelts	9.72 10.29	<b>7145001</b> <b>0145001</b>
	<i>Korķis vannas sifonam</i>				
			0411901	14.51	<b>1245001</b>
	<i>Sietiņš izlietnei, plastmasas</i>				
		35 mm 40 mm	1209 1209	0.47 0.60	<b>7445002</b> <b>7445003</b>

## Noteces

		<i>Plastmasas notece, augstā</i>				
	1,1/2"x70x54	30.106	EV10000	<b>4.57</b>	<b>6845004</b>	
		<i>Plastmasas notece virtuves izlietnei</i>				
	1,1/2"X117X63	30.301	EDVA030	<b>14.24</b>	<b>6845005</b>	
		<i>Notece</i>				
	1,1/2"x70x40	385	EDV0000	<b>4.03</b>	<b>0345008</b>	
		<i>Notece, korķis ar ķēdīti</i>				
	1,1/2"x80x37	445		<b>3.59</b>	<b>0345004</b>	
		<i>Notece</i>				
	1,1/2"x70x33	30.105	EDV1010	<b>3.39</b>	<b>6845001</b>	
		<i>Notece keramiskai izlietnei, korķis ar ķēdīti</i>				
	1,1/4"x65x23	445	EUV0000	<b>3.75</b>	<b>6845002</b>	
		<i>Dekoratīvs noslēgs izlietnei hromēts</i>				
	Ø50mm	700	25	<b>6.83</b>	<b>1245004</b>	
		<i>Dekoratīvs noslēgs izlietnei balts</i>				
	Ø50mm	700/10	10	<b>7.98</b>	<b>1245019</b>	
		<i>Pārplūdes dekoratīvais riņķis izlietnēm (caurumam 25 mm)</i>				
	Ø24mm		6002010	<b>2.75</b>	<b>1245008</b>	
		<i>Korķis ar ķēdīti</i>				
	Ø31	930		<b>2.12</b>	<b>1245009</b>	
	Ø40	930		<b>2.17</b>	<b>1245010</b>	
	Ø45.5	930		<b>2.17</b>	<b>1245011</b>	
	Ø52	930		<b>2.31</b>	<b>1245012</b>	



## Caurules un dekoratīvie šķīvīši sifoniem

VEIKALS  
EUR

		<i>Hromēta caurule ar pāreju</i>		
	Ø32x125 mm	1049905-00	<b>9.56</b>	<b>0845005</b>
		<i>Hromēta caurule</i>		
	Ø32x200 mm	84501605-00	<b>8.81</b>	<b>0845007</b>
	Ø32x250 mm	84506605-00	<b>10.92</b>	<b>0845008</b>
	Ø32x300 mm	84502505-00	<b>11.30</b>	<b>0845012</b>
		<i>Hromēta, gofrēta caurule</i>		
	Ø32x350 mm	EMCR006	<b>14.58</b>	<b>6845011</b>
		<i>Hromēta caurule ar pievienojumu veļas mašīnai</i>		
	Ø32x200 mm x 3/4"	1046205-00	<b>30.14</b>	<b>0845013</b>
		<i>Hromēta uzmava</i>		
	Ø32x60 mm	1043105-00	<b>7.22</b>	<b>0845014</b>
		<i>Sifona caurule (220 mm)</i>		
	Ø32x220 mm	E001121	<b>2.64</b>	<b>6845007</b>
	Ø40x220 mm	E001021	<b>3.00</b>	<b>6845008</b>
		<i>Sifona caurule 45°</i>		
	45°x40/50	EV20000	<b>1.71</b>	<b>6845009</b>
		<i>Sifona caurule ar 2 piesl.v.maš.</i>		
	1.1/2"x260	EMP2642	<b>6.94</b>	<b>6845010</b>
		<i>Sifona caurule, grīdā</i>		
	Ø32	02 287	<b>5.97</b>	<b>1245013</b>
	Ø40	02 415	<b>7.29</b>	<b>1245014</b>
		<i>Sifona caurule, grīdā (hromēts)</i>		
	Ø32x680x220	84500805-00	<b>50.55</b>	<b>0845015</b>
		<i>Dekoratīvā rozete</i>		
	Ø32x90x20	81075405-00	<b>10.56</b>	<b>0845017</b>
		<i>Dekoratīvā rozete</i>		
	1/2"	697	<b>0.53</b>	<b>0110204</b>
		<i>Dekoratīvā rozete</i>		
	1/2"	697/10	<b>0.83</b>	<b>0110207</b>
	3/4"	697/10	<b>1.21</b>	<b>0110208</b>
		<i>Dekoratīvā rozete</i>		
	1/2"	697/20	<b>0.66</b>	<b>0110209</b>
		<i>Plastmasas pāreja (A-I)</i>		
	1,1/2"x1,1/4"	824	<b>0.71</b>	<b>1245015</b>
		<i>Plastmasas pāreja (A-I)</i>		
	1,1/4"x1,1/2"	824/A	<b>0.71</b>	<b>1245016</b>
		<i>Gredzenveida sifona pāreja</i>		
		125701	<b>0.32</b>	<b>7445004</b>

## VEIKALS

EUR

## VEIKALS

EUR

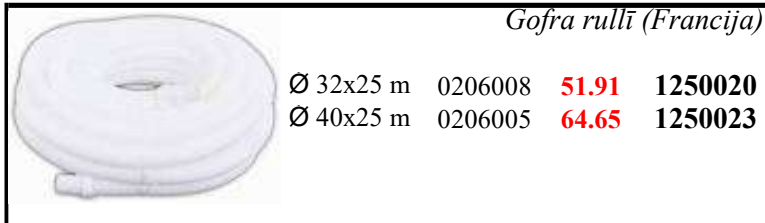

## Gofra rullī (Francija)

Ø 32x25 m	0206008	<b>51.91</b>	<b>1250020</b>
Ø 40x25 m	0206005	<b>64.65</b>	<b>1250023</b>

## Savienojums gofrai (uzgrieznis+pāreja+2 gumijas blīves)

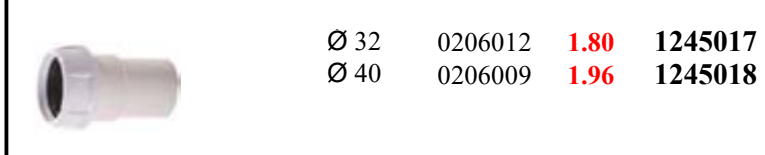

Ø 32	0206012	<b>1.80</b>	<b>1245017</b>
Ø 40	0206009	<b>1.96</b>	<b>1245018</b>

## Gofra (Francija)

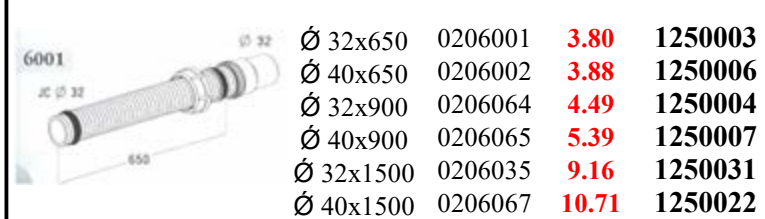

Ø 32x650	0206001	<b>3.80</b>	<b>1250003</b>
Ø 40x650	0206002	<b>3.88</b>	<b>1250006</b>
Ø 32x900	0206064	<b>4.49</b>	<b>1250004</b>
Ø 40x900	0206065	<b>5.39</b>	<b>1250007</b>
Ø 32x1500	0206035	<b>9.16</b>	<b>1250031</b>
Ø 40x1500	0206067	<b>10.71</b>	<b>1250022</b>

## Gofra ar plastmasas uzgriezni

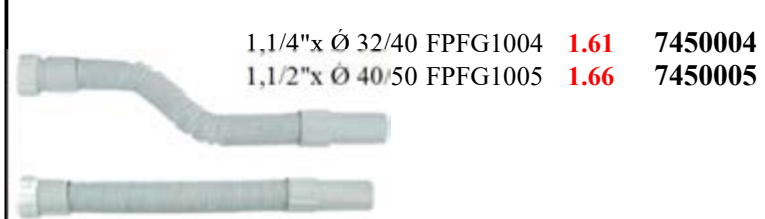

1,1/4"x Ø 32/40	FPPG1004	<b>1.61</b>	<b>7450004</b>
1,1/2"x Ø 40/50	FPPG1005	<b>1.66</b>	<b>7450005</b>

## Gofra ar metāla uzgriezni

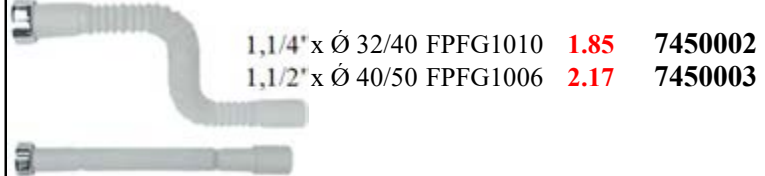

1,1/4"x Ø 32/40	FPPG1010	<b>1.85</b>	<b>7450002</b>
1,1/2"x Ø 40/50	FPPG1006	<b>2.17</b>	<b>7450003</b>

## Gofra (Itālija)

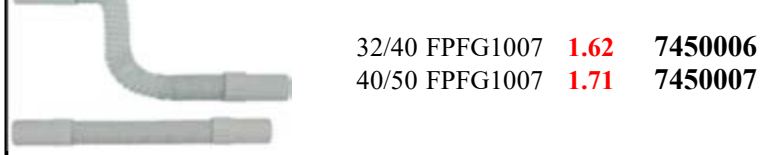

32/40	FPPG1007	<b>1.62</b>	<b>7450006</b>
40/50	FPPG1007	<b>1.71</b>	<b>7450007</b>

## Gofra

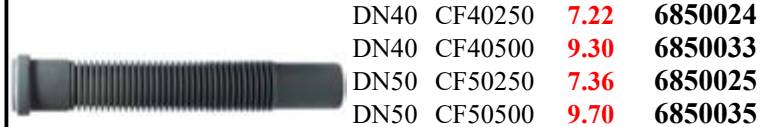

DN40	CF40250	<b>7.22</b>	<b>6850024</b>
DN40	CF40500	<b>9.30</b>	<b>6850033</b>
DN50	CF50250	<b>7.36</b>	<b>6850025</b>
DN50	CF50500	<b>9.70</b>	<b>6850035</b>

## Gofrēta uzmava

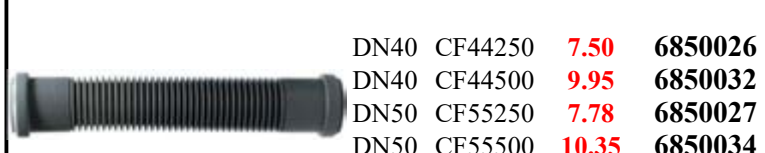

DN40	CF44250	<b>7.50</b>	<b>6850026</b>
DN40	CF44500	<b>9.95</b>	<b>6850032</b>
DN50	CF55250	<b>7.78</b>	<b>6850027</b>
DN50	CF55500	<b>10.35</b>	<b>6850034</b>

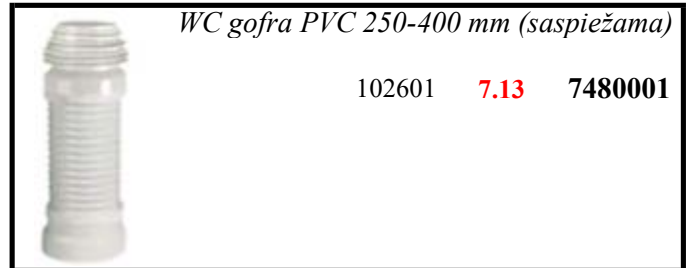

## WC gofra PVC 250-400 mm (saspiējama)

102601	<b>7.13</b>	<b>7480001</b>
--------	-------------	----------------

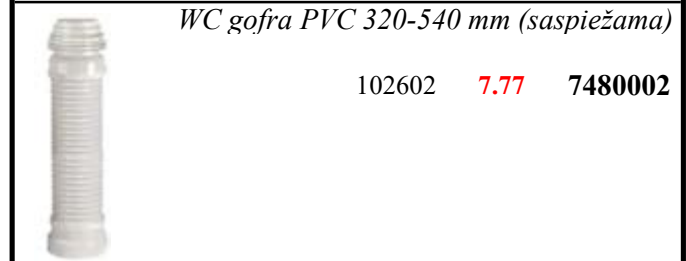

## WC gofra PVC 320-540 mm (saspiējama)

102602	<b>7.77</b>	<b>7480002</b>
--------	-------------	----------------

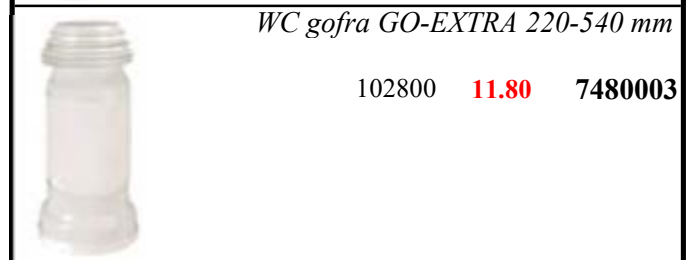

## WC gofra GO-EXTRA 220-540 mm

102800	<b>11.80</b>	<b>7480003</b>
--------	--------------	----------------



## WC gofra GO-MAGIC LUX 290-590 mm

102400	<b>6.90</b>	<b>7480004</b>
--------	-------------	----------------

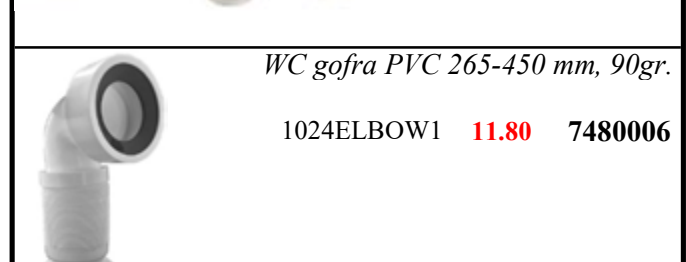

## WC gofra PVC 265-450 mm, 90gr.

1024ELBOW1	<b>11.80</b>	<b>7480006</b>
------------	--------------	----------------

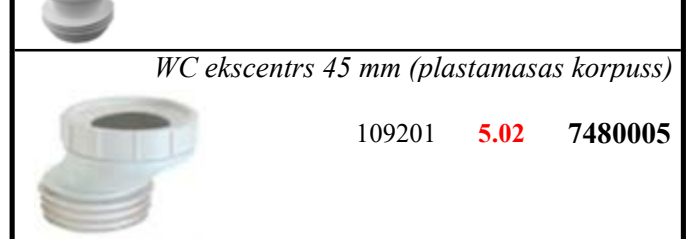

## WC ekscentrs 45 mm (plastamasas korpuss)

109201	<b>5.02</b>	<b>7480005</b>
--------	-------------	----------------



## WC manžete taisna

58 207	<b>2.56</b>	<b>6866001</b>
--------	-------------	----------------

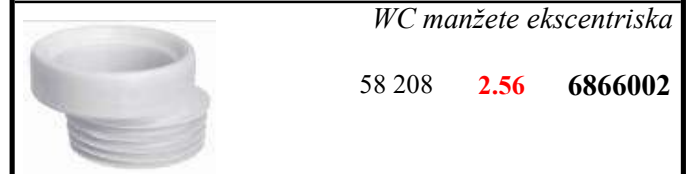





## WC manžete ekscentriskā

58 208	<b>2.56</b>	<b>6866002</b>
--------	-------------	----------------

## WC PIESLĒGI

VEIKALS  
EUR

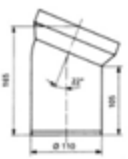



WC līkumi

			22°	58 101	KK22000	4.36	6880003
			45°	58 102	KK45000	4.42	6880004
			90°	58 103	KK90000	4.67	6880005
							

WC līkums 90° ar atzaru DN50

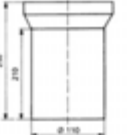
		58 110	10.08	6880009
---	---	--------	-------	---------

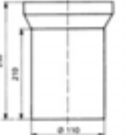
WC pieslēgs

			150 mm	58 201	KP15000	4.90	6880006
			250 mm	58 202	KP25000	5.24	6880007
			400 mm	58 203	KP40000	6.81	6880008
							

WC ekscentrs

		58 206	KE15000	8.06	6880002
---	---	--------	---------	------	---------

WC rozete

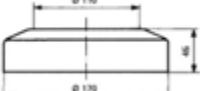
	110X170X41	58 301	KR00000	1.82	6880010
					



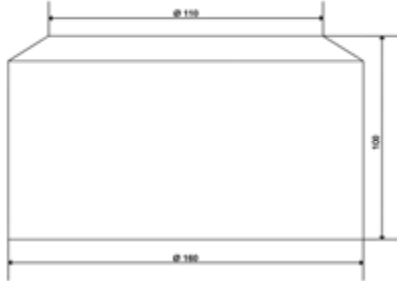





WC rozete









	110x170x100	KR1000	KR10000	3.92	6880011
					

## Skalojamās tvertnes armatūra

VEIKALS  
EUR

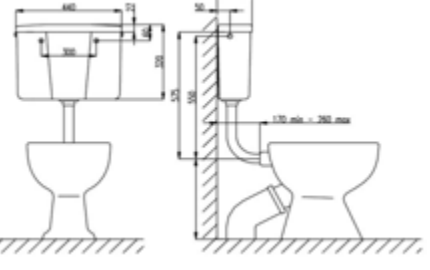

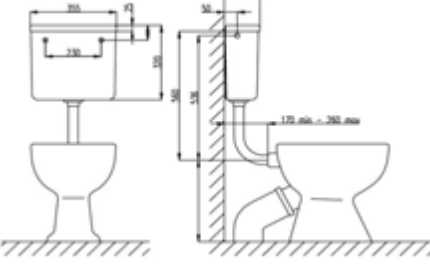







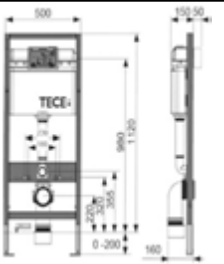

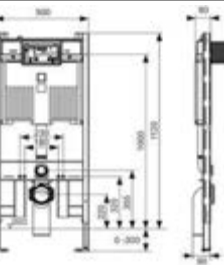
VEIKALS  
EUR

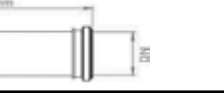
	<i>Skalojamās tvertnes armatūra universāla ar dubultpogu</i>		
0702109	33.87	1271022	
0709413	25.05	1271026	
	<i>Dubultpoga WC armatūrai</i>		
0709336	11.43	1271014	
	<i>Skalojamās tvertnes armatūra pieplūde no apakšas 3/8"</i>		
0701052	21.02	1271015	
0701053	20.62	1271004	<i>pieplūde no apakšas 1/2"</i>
	<i>Skalojamās tvertnes armatūra pieplūde no sāna 3/8"</i>		
0701058	21.02	1271016	
0701059	20.62	1271005	<i>pieplūde no sāna 1/2"</i>
0701122/PL	22.91	1271023	<i>īpaši netīram ūdenim 1/2"</i>
	<i>Skalojamās tvertnes armatūra universāla ar STOP - pogu</i>		
0702109 PL	12.85	8871009	
	<i>Skalojamās tvertnes armatūra universāla ar dubultpogu</i>		
0702108 PL	13.12	8871002	
	<i>WC armatūras poga ar STOP</i>		
ZSK/305/0/L	4.07	8871023	
	<i>Dubultpoga WC armatūrai</i>		
ZSD/012/0/L	4.65	8871024	
	<i>WC tvertnes uzpildes mehānisms pieplūde no apakšas 1/2" PL</i>		
0701053 PL	6.42	8871005	
			<i>pieplūde no apakšas 3/8"</i>
0701052 PL	5.75	8871008	

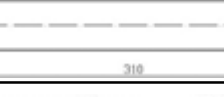

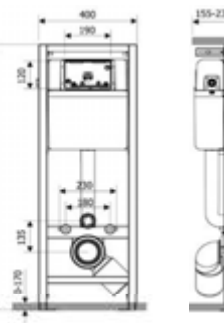
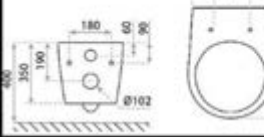

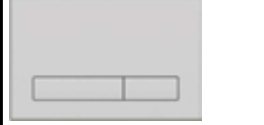









<i>Skalojamās tvertnes armatūra pieplūde no sāna</i>			
7001OTT	1/2"	7.98	7471001
7001OTT	3/8"	3.09	7471003
			
<i>Pludiņš WC tvertnes uzpildes mehānismam</i>			
	1040000001	0.89	7471002
<i>WC tvertnes uzpildes mehānisms pieplūde no sāna</i>			
600-95133	3.77	8871004	
0701059PL	1/2" PL		
600-98039	3.75	8871007	
0701058PL	3/8" PL		
			
<i>WC skalojamā tvertne, balta 600-5003195K</i>			
	95K	26.92	8871010
			
<i>WC skalojamā tvertne, balta 600-90001M99</i>			
	M99	25.40	8871011
			
<i>Skalojamās tvertnes armatūra M99</i>			
	600-56001	6.71	8871006

VEIKALS



















EUR









		<p>Zemapmetuma rāmis podam ar baltu taustiņu</p> <p>9400400 <b>256.87</b> 4771009</p>
		<p>Zemapmetuma rāmis podam, īpaši plāns</p> <p>9300500 <b>322.13</b> 4771034</p>
		<p>WC īscauruļu komplekts, garums 30 cm</p> <p>9820214 <b>36.38</b> 4771010</p>
		<p>WC caurules pagarinājums DN90</p> <p>KP93510 <b>13.25</b> 6880013</p>
		<p>WC caurules pagarinājums DN44</p> <p>KP43000 <b>5.75</b> 6880014</p>
		<p>Zemapmetuma rāmis podam</p> <p>ZSP/M400/0/K <b>122.08</b> 8871014</p> <p>Komplekts (rāmis + pods + taustiņš) ZSP/M400/kompl <b>271.55</b> 8871019 (8871014+8277071+8871015)</p>
		<p>Piekaramais pods ARCTIC, Lavita</p> <p><b>110.40</b> 8277071</p>
		<p>Izolācijas plāksne piek.podam, univers.</p> <p>350/A/108 <b>4.86</b> 8866000</p>
	<p>M16</p> <p>MELNA/MATĒTA SATĪNS</p>	<p>Taustiņš zemapmetuma rāmim</p> <p>350/PPC/100 <b>32.99</b> 8871026 350/PPS/015 <b>30.93</b> 8871027</p>
	<p>M05</p> <p>MATĒTS HROMS BALTA</p>	<p>Taustiņš zemapmetuma rāmim</p> <p>350/PPS/058 <b>27.54</b> 8871015 350/PPG/056 <b>32.20</b> 8871016 350/PPB/055 <b>20.33</b> 8871025</p>
	<p>M11</p> <p>MATĒTS HROMS BALTA</p>	<p>Taustiņš zemapmetuma rāmim</p> <p>SPP/111 <b>29.87</b> 8871017 SPP/112 <b>34.65</b> 8871018 SPP/110 <b>22.65</b> 8871021</p>







	VEIKALS	EUR	
	780		Gumijas manžetes
	32x26	0.71	4466016
	40x32x26	0.72	4466015
	50x32x26	0.74	4466013
		0.72	4466014
	780		Gumijas manžetes
	14x38	4.26	0566001
	32x75	1.81	4466002
	40x75	1.79	4466001
	50x75	1.92	4466011
	780		Gumijas manžetes
	40x60	1.25	0166012
	Gumijas manžetes, balta "STEDO"		
	780		
	100x100	3.55	4466012
	780-M		Gumijas manžete
	100x100	3.46	4466004
	780		Gumijas manžete "NEW PRO"
	melna 100x100	4.33	4466006
	780		Gumijas manžete "NEW"
	balta 100x100	4.32	4466005
	780		Gumijas manžete, universāla
	70x75x50x40	4.93	4466007
	780		Gumijas manžete
	D40	0.93	4466008
	D50	0.93	4466009
	997799		Svina plomba skaitītājiem
		0.21	2329001
	997809		Stieple plombēšanai (100m)
		27.12	2329002
	997798		Stieple plombēšanai (40cm)
		0.13	2329003
	Dzīvokļu skaitītājs aukstajam ūdenim		
	1/2"	25.85	4529001
	Dzīvokļu skaitītājs karstajam ūdenim		
	1/2"	25.85	4529004
	Dzīvokļu skaitītājs aukstajam ūdenim		
	3/4"	31.05	4529002

	VEIKALS	EUR	
	Dzīvokļu skaitītājs karstajam ūdenim		
	3/4"	31.05	4529006
	Māju ūdens skaitītājs aukstajam ūdenim		
	1/2"	54.93	4529015
	3/4"	57.85	4529003
	1"	83.78	4529005
	1,1/4"	143.24	4529007
	1,1/2"	181.01	4529010
	Māju ūdens skaitītājs karstajam ūdenim		
	1/2"	76.73	4529030
	3/4"	41.14	4529009
	1"	133.29	4529008
	1,1/4"	122.36	4529012
	1,1/2"	215.46	4529013
	Manometrs 0-6 bar, 63 mm 1/4"		
	4011 sāna	5.53	3829001
	Manometrs 0-10 bar, 63 mm 1/4"		
	4011 sāna	5.53	3829002
	Manometrs 0-10 bar, 55 mm 1/4"		
	GO PLAST sāna	5.40	7429001
	Manometrs 0-4 bar, 100 mm		
	4010 sāna	13.20	3829009
	Manometrs 0-6 bar, 100 mm		
	sāna	13.20	3829010
	Manometrs 0-10 bar, 100 mm		
	sāna	13.20	3829011
	Manometrs 0-16 bar, 100 mm		
	sāna	13.20	3829012
	Nepieciešama pāreja uz 1/2"		
	Manometrs 0-6 bar, 63 mm 1/4"		
	4011		
	aizmugures	5.06	3829003
	Manometrs 0-10 bar, 63 mm 1/4"		
	4011 aizmugures	5.06	3829004
	Manometrs 0-10 bar, 55 mm 1/4"		
	GO PLAST aizmugures	5.42	7429002
	Termomanometrs 0-6 bar, 80 mm, 1/2"		
	4013 aizmugures	16.78	3829006
	Termomanometrs 0-6 bar, 80 mm, 1/2"		
	4013 sāna	16.78	3829007
	Termometrs 120°C, 63 mm 1/2"		
	4012 aizmugures	7.10	3829005
	Termometrs 120°C, 63 mm stiprināms ar atsperi		
	4012 virsmas	7.77	3829008
	Redukcija manometram 1/2"xM20x1.5 izmantojama manometriem D100		
	607.402	2.77	0925307

# Skrūves un stiprinājumi



















		GAB.		VEIKALS EUR		
	100	<i>Metāla stiprinājums</i>				
	3/8"	14-18	100	<b>0.72</b>	1422049	
	1/2"	20-25	100	<b>0.74</b>	1422034	
	3/4"	25-30	100	<b>0.83</b>	1422035	
	1"	31-36	100	<b>0.88</b>	1422036	
	1,1/4"	40-44	50	<b>0.88</b>	1422037	
	1,1/2"	50-58	50	<b>0.90</b>	1422039	
	2"	60-64	50	<b>0.93</b>	1422038	
	2,1/2"	75-80	50	<b>1.98</b>	1422040	
	3"	85-92	25	<b>1.97</b>	1422041	
	4"	110-118	25	<b>2.29</b>	1422043	
	5"	133-141	25	<b>5.15</b>	1422050	
6"	159-168	25	<b>5.57</b>	1422051		
10"	230-260	-	<b>6.20</b>	1422053		
	111	<i>Metāla stiprinājums ar gumijas blīvi</i>				
	3/8"	14-18	100	<b>0.91</b>	1422064	
	1/2"	20-25	100	<b>0.80</b>	1422024	
	3/4"	25-30	100	<b>0.81</b>	1422025	
	1"	31-36	100	<b>0.87</b>	1422026	
	1,1/4"	40-44	50	<b>0.97</b>	1422027	
	1,1/2"	44-50	50	<b>1.06</b>	1422028	
	2"	60-64	50	<b>1.14</b>	1422029	
	2,1/2"	75-80	50	<b>1.61</b>	1422030	
	3"	85-92	25	<b>2.60</b>	1422031	
	4"	110-118	25	<b>1.98</b>	1422033	
	5"	133-141	20	<b>4.69</b>	1422063	
6"	159-168	20	<b>5.50</b>	1422044		
<i>Komplekts radiatoru stiprināšanai ar atgaisotāju un korķi</i>						
		9824UK	<b>8.19</b>	1722058		
	783	<i>Skrūves izlietnei (2 gab.)</i>				
	8x100	50	<b>1.44</b>	1422018		
	8x120	50	<b>1.53</b>	1422019		
	8x150	50	<b>1.60</b>	1422020		
		784	10x100	50	<b>1.67</b>	1422021
		10x120	50	<b>2.19</b>	1422022	
10x140		50	<b>2.08</b>	1422023		
250/A	<i>Stiprinājums poda vākam (plastmasas)</i>					
			<b>1.20</b>	7422001		
250/C	<i>Stiprinājums poda vākam (hromēts)</i>					
			<b>1.81</b>	7422002		
	787	<i>Stiprinājumi WC skalojamai kastei</i>				
	105 mm		<b>7.37</b>	7822001		
	785	<i>Skrūves podam komplektā</i>				
	baltas	50	<b>0.94</b>	1422016		
	hromētas	50	<b>0.97</b>	1422017		
	782	<i>Skrūves boileriem 2 gab.</i>				
	10x95	10	<b>1.40</b>	0122000		
	<i>Klipšveida stiprinājums siltajām grīdām</i>					
	15-20 mm	01990	<b>0.05</b>	1722033		
	15-20 mm	01995	<b>0.06</b>	1722034		
	011	<i>Plastmasas turētājs ar dībeli</i>				
	15mm	50	<b>0.25</b>	1422013		
	18mm	50	<b>0.30</b>	1422014		
	20mm	50	<b>0.41</b>	1422015		
	25mm	50	<b>0.43</b>	1422045		
	32mm	50	<b>0.66</b>	1422046		
	9826FK	<i>Klipšveida turētājs</i>				
	15-18	50	<b>0.09</b>	1722036		
	20-22	50	<b>0.10</b>	1722037		
	25-28	50	<b>0.11</b>	1722038		
	32-35	50	<b>0.17</b>	1722039		
	9826ZK	<i>Klipšveida turētājs (zaļš)</i>				
	20-22 mm	100	<b>0.03</b>	7622001		
	24-25 mm	50	<b>0.03</b>	7622002		
	32 mm	50	<b>0.03</b>	7622003		
	9826AK	<i>Klipšveida stiprinājums</i>				
	10	100	<b>0.29</b>	1722001		
	12	100	<b>0.22</b>	1722002		
	14-15	100	<b>0.18</b>	1722003		
	16-18	100	<b>0.19</b>	1722004		
	20-22	50	<b>0.23</b>	1722005		
	25-28	50	<b>0.69</b>	1722006		
35	25	<b>0.64</b>	1722059			
	9827AK	<i>Klipšveida stiprinājums dubultais</i>				
	10	100	<b>0.10</b>	1722007		
	12	100	<b>0.35</b>	1722008		
	14-15	100	<b>0.25</b>	1722009		
	16-18	100	<b>0.34</b>	1722010		
	20-22	50	<b>0.36</b>	1722011		
25-28	50	<b>0.37</b>	1722030			
35	25	<b>0.88</b>	1722060			
	9826EK	<i>Klipšveida stiprinājums</i>				
	15	50	<b>0.26</b>	1722012		
	16	50	<b>0.26</b>	1722013		
	18	50	<b>0.27</b>	1722014		
	20	50	<b>0.28</b>	1722015		
	22	50	<b>0.30</b>	1722016		
	25	50	<b>0.34</b>	1722017		
	28	50	<b>0.34</b>	1722018		
32	50	<b>0.53</b>	1722019			
	9827EK	<i>Klipšveida stiprinājums dubultais</i>				
	15	40	<b>0.37</b>	1722020		
	16	40	<b>0.61</b>	1722021		
	18	40	<b>0.45</b>	1722022		
	20	40	<b>0.71</b>	1722023		
	25	40	<b>1.02</b>	1722025		

		GAB.	VEIKALS EUR	
9826BK		<i>Stiprinājums plastmasas caurulēm</i>		
	32	50	1.03	1722026
	40	40	1.01	1722027
	50	40	1.15	1722028
	75	40	1.25	1722061
	110	40	1.69	1722029
2020		<i>Izolācijas skava</i>		
			2.36	1722040
2009		<i>Skava caurulei (grīdas siltināšanai)</i>		
	100		9.62	7822002
	250		10.80	1722041
91230		<i>Takers skavas stiprināšanai</i>		
	1gb		260.86	1735010
01860P		<i>Cauruļu stiprinājums ar dībeļnaglu</i>		
	25mm	200	0.08	1722031
01970P		<i>Cauruļu stiprinājums ar dībeļnaglu dubults</i>		
	25mm	100	0.10	1722032
		<i>Āķītis ar dībeli</i>		
	04368 8mm	100	0.53	1422060
	04369 10mm	50	0.90	1422061
		<i>Vītņstienis</i>		
	8x1000mm	976-08X1	1.39	1422055
	8x2000 mm	976-08X2	3.86	1422066
	10090		1.58	1422056
	10x1000mm			
		<i>Uzgrieznis vītņstienim</i>		
	16002 8x24mm		0.23	1422057
	16004 10x30mm		0.44	1422058

		GAB.	VEIKALS EUR	
		<i>Savilcēji (nerūsējošs tērauds)</i>		
	8-16	50	0.36	1627001
	12-20	50	0.37	1627002
	16-24	50	0.40	1627003
	20-32	50	0.43	1627004
	25-40	50	0.41	1627005
	32-50	50	0.48	1627006
	40-60	50	0.48	1627007
	50-70	50	0.48	1627008
	60-80	50	0.61	1627009
	70-90	25	0.63	1627010
	80-100	25	0.70	1627011
	90-110	25	0.73	1627012
	100-120	25	0.75	1627013
	110-130	25	0.99	1627014
	120-140	25	1.03	1627015
	140-160	25	1.10	1627016
		<i>Savilcēji (nerūsējošs tērauds)</i>		
	23-25	10	1.37	1627017
	26-28	10	1.37	1627031
	29-31	10	1.37	1627018
	32-35	10	1.37	1627019
	36-39	10	1.48	1627034
	40-43	10	1.64	1627020
	44-47	10	1.87	1627021
	48-51	10	2.05	1627032
	52-55	10	2.27	1627033
	56-59	10	2.57	1627022
	60-63	10	2.97	1627023
	64-67	10	3.40	1627024
	68-73	10	3.54	1627025
	74-79	10	3.64	1627026
	80-85	10	3.76	1627027
	86-91	10	3.91	1627028
	92-97	10	4.04	1627029
	98-103	10	4.17	1627030
2215		<i>Dekoratīvais šķīvītis, jaucams (balts)</i>		
	15	100	0.29	1770001
	16	100	0.23	1770003
	18	100	0.23	1770002
	20	100	0.24	1770004
	22	100	0.23	1770005
	28	100	0.25	1770006
2215/C		<i>Dekoratīvais šķīvītis, jaucams (hromēts)</i>		
	15	100	1.37	1770007
	16	100	1.37	1770008
	18	100	1.39	1770009
	20	100	1.41	1770010
	22	100	1.43	1770011
	28	100	1.44	1770012
2220		<i>Dekoratīvais dubultais šķīvītis (balts)</i>		
	15	50	0.78	1770013
	16	50	0.81	1770014
	18	50	0.70	1770015
	20	50	0.66	1770016
	22	50	0.77	1770017
	28	50	0.66	1770018
2220/C		<i>Dekoratīvais dubultais šķīvītis (hromēts)</i>		
	15	50	3.73	1770019
	16	50	3.73	1770020
	18	50	3.73	1770021
	20	50	3.73	1770022
	22	50	3.73	1770023
	28	50	3.73	1770024















## BLĪVES





		VEIKALS EUR		VEIKALS EUR						
	796	<i>Paranīta blīve</i>		<i>Gumijas blīves dozātoram</i>						
		3/8"(100)	3.78	0166022		215 V/796	Ø 12 mm	0.35	0566002	
		1/2"(100)	4.59	0166003		216 V/796	Ø 28 mm	0.35	0566003	
		3/4"(100)	7.95	0166004	<i>Gumijas blīve (čuguna veidgabaliem)</i>					
		1"(10)	1.32	0166008		03576	1/2"	0.32	2166001	
		1,1/4"(10)	2.62	0166009			3/4"	0.28	2166002	
	1,1/2"(10)	2.50	0166015			1"	0.46	2166003		
	2"(10)	3.66	0166016			1,1/4"	0.74	2166005		
						1,1/2"	0.66	2166004		
						2"	0.68	2166006		
	03572	<i>Gumijas blīve</i>								
		3/8"(100)	3.15	0466004		1/2" (10)	1.81	2166009		
		1/2"(100)	3.36	0466002		3/4" (10)	2.43	2166010		
		3/4"(100)	5.36	0466005		1" (10)	2.80	2166011		
		1"(10)	1.29	0466008		1,1/4" (10)	4.30	2166012		
		1,1/2"(10)	2.14	0466006		1,1/2" (10)	3.89	2166013		
	03574	<i>Gumijas blīve ar sietiņu</i>								
		3/8"	0.60	0466013		GUA 11	<i>Blīves PE savienojumiem</i>			
		1/2"	0.59	0466001		19x3,5	DN20	0.42	9066007	
		3/4"	0.94	0466003		24x4	DN25	0.45	9066008	
		3/8"(10)	3.50	0466012		31x4,5	DN32	0.65	9066009	
	1/2" (10)	3.50	0466010	39x5,5		DN40	0.80	9066010		
	796/S	<i>Gumijas blīve iztekai</i>								
		Ø 16 mm(10)	6.90	0166018		<i>Blīve (konuss) bezvītņu savienojumiem</i>				
		Ø 18 mm(10)	3.28	0166005		03575	1/2"	1.24	0966001	
	797	Pārslēdzējam(1)	0.25	0166031			3/4"	1.66	0966002	
	Pārslēdzējam(10)	0.64	0166001			1"	1.85	0966003		
	796/G	<i>Plastmasas gredzens iztekai</i>								
		Ø 18 mm	0.26	0166020		1,1/4"	2.26	0966004		
	796/675	<i>Gumijas blīve dozātoriem</i>								
		Ø 18 mm (10)	2.62	0166028		1,1/2"	2.57	0966005		
		1/2"	0.59	0166007		2"	3.65	0966006		
	796/V	<i>Gumijas blīve krāna ventilim</i>								
		1/2"	1.20	0166013		1/2" (10)	7.10	0966019		
		3/8" (10)	6.88	0166029		3/4" (10)	9.41	0966020		
		1/2" (10)	7.07	0166030		1" (10)	10.30	0966021		
	R302-1078	Ø 35	5.42	0166019		<i>Blīves trīsdaļīgiem savienojumiem</i>				
	R302-0130	Ø 40	6.12	0166021			1,1/4"	0.59	0966011	
<i>Blīve virtuves jaucējkrānam</i>							1,1/2"	0.66	0966010	
	R 302-35 mm	Ø 35	2.94	0166023			2"	0.73	0966012	
	R 302-40 mm	Ø 40	3.00	0166024			1/2" (10)	1.77	0966013	
	03573	<i>Gumijas blīve ekscentriem</i>					3/4" (10)	2.32	0966014	
		(10)	0.14	1166003			1" (10)	2.86	0966015	
	03571	<i>Gumijas blīve sifoniem (konuss)</i>					1,1/4" (10)	3.27	0966016	
		Ø 32 mm	0.37	7466001			1,1/2" (10)	3.68	0966017	
		Ø 40 mm	0.43	7466002			2" (10)	4.09	0966018	
	<i>Blīvju komplekts pedāļa dozātoram</i>						<i>Blīve WC skalojamai kastei</i>			
	401/796K		1.26	0566004	781		2.13	7866001		
	401/796	<i>Blīve pedāļa dozātoram</i>				<i>Blīve aeratoram ar ārējo vītņi</i>				
			0.35	0566005	03580		0.16	1166004		
						03580/10		0.92	1166006	
						<i>WC blīve skalojamai kastei podam</i>				
						U093		6.25	7866002	

# Blīvējumu materiāli

VEIKALS  
EUR

VEIKALS  
EUR

		<p>Blīvējamā pasta "UNIPAK"</p>	
65 gr	3.94	2566011	
250 gr	7.31	2566012	
			
		<p>Blīvējamā pasta "UNIPAK"</p>	
360 gr	8.10	2566013	
			
		<p>Teflona lente "UNITAPE"</p>	
12x12x0,075 mm	0.75	2566002	
			
		<p>Teflona lente "JUMBOTAPE"</p>	
10x19x0,2 mm	4.12	2566004	
			
		<p>Teflona lente "MAXITAPE"</p>	
12x12x0,1 mm	1.45	2566003	
			
		<p>Teflona lente "MIDITAPE"</p>	
12x12x0,1 mm	1.18	2566001	
			
		<p>Teflona lente</p>	
12x12x0,075 mm	0.27	4366001	

		<p>Teflona lente</p>	
19x15x0,25 mm	2.82	2566018	
		<p>Vītņu blīvējamais diegs, LOCTITE 55</p>	
50 m	8.40	2366001	
		<p>Vītņu blīvējamais diegs, LOCTITE 55</p>	
160 m	17.31	2366002	
		<p>Auduma, mitrumizturīga limlenta, pelēka</p>	
48mmx50m	8.06	2566019	
		<p>HT smērvielā</p>	
150 gr	3.23	6866003	
250 gr	3.76	6866004	
1000 gr	10.25	6866005	
		<p>Vītņu blīvējamais diegs, MAGMA</p>	
20 m	4.03	7166005	
50 m	5.55	7166003	
150 m	11.66	7166004	
			

VEIKALS  
EURVEIKALS  
EUR

 <p><i>Blīvējamā pasta "GEBATOUT 2"</i></p> <p>80 gr PASTA-GEB <b>3.34</b> 6766001 200 gr PASTA-GEB <b>4.94</b> 6766002</p> <p><i>Izmanto ūdens, gāzes un saspiesta gaisa sistemās. Savienojuma spiediena izturība līdz 200Bar, max t° līdz 130°</i></p>	 <p><i>Lini mīkstā spole</i></p> <p>100 g <b>3.89</b> 2566009 515031 80 gr <b>Francija</b> <b>3.91</b> 6766036</p>
 <p><i>Blīvējamā pasta "GEBATOUT 2"</i></p> <p>500 gr PASTA-GEB <b>6.65</b> 6766003</p>	 <p><i>Lini 80 gr (plastmasas traukā)</i></p> <p>515030 80 gr <b>Francija</b> <b>7.97</b> 6766022</p>
 <p><i>Instalācijas komplekts</i></p> <p>Blisteris 80g+20g <b>5.95</b> 6766031</p>	 <p><i>Hermetizējoša aukla no 100% teflona</i></p> <p>80 m 815500 <b>10.47</b> 6766007</p> <p>Iztur hidrotriecienu un vibrāciju. T° izturība no -190° līdz +260°; spiediens līdz 15Bar. Pietiek 65gab 1/2 savienojumiem.</p>
 <p><i>Blīvējamā mastika FILGUM</i></p> <p>200 gr 104019 <b>4.62</b> 6766045</p> <p>Elastīga mastika spraugu blīvēšanai. Savienojuma vietu, šuvju un plaisu hermetizācijai un aizpildīšanai. Santehnikas iekārtu (notekas, sifoni, izlietnes, vannas, tualetes u.c.) uzstādīšanas laikā radušos spraugu blīvēšanai.</p>	 <p><i>Hermetizējoša blīvējamā aukla</i></p> <p>100 m 515100 <b>26.94</b> 6766006</p> <p>Pie ietojams metāla un plastmasas savienojumiem. Iztur hidrotriecienu un vibrāciju. Aukstā ūdens spiediena izturība max 16Bar. Pie 130°C max 7Bar.</p>
 <p><i>Silikona hermētiķis "GEBSICONE W"</i></p> <p>"W" balts 310 ml 893400 <b>7.40</b> 6766004 "W" C.S. 310 ml 893403 <b>7.40</b> 6766005</p>	 <p><i>Hermetizējoša blīvējamā aukla</i></p> <p>25 m 515200 <b>6.39</b> 6766041</p>
 <p><i>Kusnis lodēšanai ar alvu "HAMPTON"</i></p> <p>Kusnis lodēšanai ar alvu. Satur cinka hlorīdu. Paredzēts dzelzs, tērauda, čuguna, vara, bronzas, misiņa, cinka u.c. metālu lodēšanai izņemot alumīniju! Aktivizējas pie +75°C līdz +375°C.</p> <p>175 gr 100111 <b>11.48</b> 6735002</p>	 <p><i>Teflona lente "RUBAN"</i></p> <p>12mm*12m*0,075mm <b>0.60</b> 6766009 ķīmiskām</p>
 <p><i>Alva lodēšanai SN9</i></p> <p>Sn97Cu3</p> <p>100 gr 815708 <b>20.88</b> 6735004</p>	 <p><i>Zila Fum lente</i></p> <p>12mm*12m*0,1mm <b>0.86</b> 6766010</p> <p>Nejūtīga pret ķīmiskām piedevām un mikro organismiem. Spiediena izturība max 15Bar (silts/auksts), temperatūras izturība no -260° līdz +260°</p>
 <p><i>Līme vara un misiņa savienojumiem "RLC+"</i></p> <p>30 ml 814655 <b>17.53</b> 6766046</p>	 <p><i>Fum lente degvielai un eļļām</i></p> <p>12mm*12m*0,1mm <b>1.26</b> 6766032</p> <p>Nejūtīga pret ķīmiskām piedevām un mikro organismiem. Izmantojama arī <b>degvielai un eļļām</b>. Degvielai, Spiediena izturība max 15Bar (silts/auksts), temperatūras izturība no -260° līdz +260°. Blīvums 0.8mm</p>
 <p><i>Lini fice</i></p> <p>100 g <b>Francija</b> <b>1.71</b> 6766023 200 g <b>3.75</b> 2566007 500 g <b>9.03</b> 2566008</p>	 <p><i>Zaļa Fum lente</i></p> <p>19mm*15m*0,2mm <b>3.96</b> 6766011</p>
	 <p><i>Fum lente gāzei</i></p> <p>12mm*12m*0,1mm <b>3.40</b> 6766012</p> <p>Izcila ķīmiskā inerce: butāna, propāna, dabasgāzes, saspiesta gaisa, slāpekļa, ūdeņraža, hēlija, argona, uc gāzēm. Temperatūras izturība -260° līdz +260° C</p>

**VEIKALS  
EUR**

**VEIKALS  
EUR**

## GEB-KIT



4/5/6\*2,5 m **15.90 6772002**  
7/8\*2,5 m **16.12 6772003**  
10\*2,5 m **18.62 6772004**

Hermetizācijas komplekts krāšņu piedurļiņiem.  
1. Apaļa termo aukla (Ø 5x2,5 m)+Collafeu (20ml)  
2. Apaļa termo aukla (Ø 8x2,5 m)+Collafeu (20ml)  
3. Plakana termo aukla (10mmx2.5mmx2.5m)+Collafeu (20ml)  
(Collafeu – termoizturīga līme šķiedrainai izolācijas materiālu pielīmēšanai pie virsmām, kuras pakļautas augstām temperatūrām, līdz +1100°C)

## GEB-COLLAFEU



50 ml **5.40 6772006**

Termoizturīga līme šķiedrainu izolācijas materiālu pielīmēšanai pie virsmām, kuras pakļautas augstām temperatūrām (līdz +1100°C)

## GEB-CALORYGEB



300 gr. **5.65 6772008**  
310 ml **8.09 6772007**

Ugunsizturīga mastika, kuru viegli pielietot montējot krāsnis, kamīnus, kā arī veicot remontdarbus un novēršot defektus to virspusē. Izmantojams kā hermētiķis plaisām un salaiduma vietās ar kurtuvi, dūmvadu u.c. Temperatūras izturība līdz +1100°C. Uzklāt uz tīras, samitrinātas virsmas. Lietot 90% CALORYGEB un 10% ūdens. Ļaut nožūt 48 stundas.

## GEB-PROPFEU POWDRE



900 gr. **12.46 6772011**

Kīmiskai dūmvadu apstrādei. Efektīvi noņem darvu, sveķus un nosēdumus, kurus nevar noņemt mehāniski. Uzbērt uz kvēlojošām oglēm ieteicamo mērtrauciņu skaitu. Katalītiska reakcija pārvērtīs darvu un sveķus par nedegošiem. Daļa nokritīs kurtuvē, daļa tiks iznesta ar vilkmi. Ja nepieciešams pēc tam tiek veikta mehāniskā dūmvada tīrīšana. Nelietot šķidrā kurināmā un gāzes katlos.

## GEB-PROPFEU



500 ml **11.30 6772009**

Līdzeklis kamīnu/ krāšņu stiklu tīrīšanai. Ātri šķīdina darvas un kvēpu nosēdumus. Nelietot alumīnija virsmām. Instrukcija: Aizsargājiet (apsedziet) apkārtējās virsmas ar lupatu. Izsmidzina uz aukstas vai siltas virsmas. Ļauj iedarboties 1 minūti. Notīra

## GEB-DEBOUCHEUR UNIVERSEL

1 L **8.82 6772013**



Šķidrums līdzeklis aizsērējumu attīrīšanai dušas kabīnēs, izlietnēs un kanalizācijā. Var izmantot emaljētām virsmām, fajansam, nerūsējošam tēraudam, hromētām virsmām, čuguna un plastmasas cauruļvadiem. Ieliet 0.5 l šķīduma sifonā (1 l podiem) un atstāt no 30 min., līdz 12 h, atkarībā no aizsērējuma. Skatīt ar lielu daudzumu ūdens. Nekādā gadījumā šo līdzekli nejaukt ar citiem līdzekļiem!!!

## GEB-DEBOUCHEUR PROFESIONEL

1 L **9.54 6772012**



Ļoti iedarbīgs (spēcīgs) šķidrums līdzeklis izšķīdina kaļķa nogulsnes, organiskus u.c. savienojumus. Liet līdzekli kanalizācijā (izmantojot piltuvi). Skatīt ar lielu daudzumu ūdens. Tualetes (izņemot ķīmiskās) ½ -1 iep., izlietnes ¼ - ½ iep., kanalizācija ¼ -1/2 iep. Līdzeklis nav lietojams emaljētām un hromētām virsmām. Nekādā gadījumā šo līdzekli nejaukt ar citiem līdzekļiem!!! Izdala siltumu.

VEIKALS  
EUR

VEIKALS  
EUR

### GEB-DEBOUCHEUR KIT

Ø25-Ø50 **28.59** 6735006



Mehāniskās cauruļu tīrīšanas komplekts „Kit Deboucheur”  
Lietošanas instrukcija: Izmantojiet cimdus un aizsargbrilles. Pirms lietošanas nepieciešams: 1) Izjaukt sifonu, ja sifona caurule nav pieejama. 2) Nobloķēt pārplūdi, kā arī blakus izlietni, ja tāda ir uzstādīta. 3) Ja ir uzstādīta vēl kāda caurule pirms aizsprosta, arī tās izeja ir jānobloķē. 4) Ja nav iespējams pilnībā ievietot mehānisko cauruļu tīrītāju (atbloķētāju) caurulē, izmantojiet komplektā esošo caurulīti un lieciet to pie noteces. Pilnībā ievietojiet atbloķētāju caurulē un atveriet ūdeni lēnā plūsmas režīmā, ūdens temperatūrai jābūt zemākai par 30°C, Kad atbloķētājs būs piepildījies ar ūdeni, tas nosprostos cauruli. Starp atbloķētāju un aizsprostu piepildīsies ūdens kas izspiedīs vai izjauks aizsprostu. Nelietot ar karsto ūdeni. Nelietot WC podā. Nelietot gofrās un lokanās caurulēs. Nelietot, ja pirms tam izmantots ķīmiskais cauruļu tīrīšanas līdzeklis

### GEB-SPRAY

500 ml **9.50** 6766028



Aerosols uz 100% silikona eļļas bāzes, nelīpoša un ūdensizturīga, paredzēta:  
Eļļošanai, aizsardzībai pret mitrumu, lipšanas novēršanas līdzeklis gumijai, novērš blīvju nodilšanu un deformācijas. Palīg līdzeklis izņemšanai no formas, novērš vaska vai saistvielu lipšanu, ideāli piemērots puteklainai videi, lietošanai ar tvertni gan uz augšu, gan uz leju.

### GEB-PLAQUE

1m2 **38.32** 6766017



Termoizolējošs minerālu pārklājs. Pielieto krāsns virsmu, dūmvadu, kurtuvju apdarei un sienu izolācijai no karstuma iekārtām. Līdz +1100°C. Paklāja fiksācijai pielieto līmi - COLLAFEU

### GEB-GEBEX

200 gr **3.62** 6766015  
500 gr **5.17** 6766016



Montāžas smēre cauruļvadiem kura nesatur silikonu. Pielieto plastikas cauruļvadu montāžā, uzmašanās un gumijas blīvju uzstādīšanā u.c. \*Piemērots spiediena un kanalizācijas caurulēm. \*Nodrošina vieglu slīdēšanu. \*Aizsargā gumijas blīvējumus.

### Daudzfunkcionālā līme-mastika "GEB-MS"

280 ml 892001 **10.52** 6766042



Vienkomponenta blīvēšanas un līmēšanas mastika, kura izgatavota no MS Polymer. Sacietē saskarē ar apkārtējās vides mitrumu: Pielietojums: Ūdensizturīgu šuvju aizpildīšana būvniecībā (betons, koks, stikls, metāls, PVC u.c.). Izplešanās šuvju aizpildīšana. Hidroizolācijas šuves starp mūri un koku. Zem koka, metāla vai PVC apdares materiālu apakšējās daļas. Plaisu aizpildīšana. Līmēšana iekšējās un ārpus tām (apšuvuma briketes, līstes, cokoli, polistirola elementi, spoguļi, ventilācijas atveres, elektrības kastes, akustiskā izolācija utt.).

### GEB-GEBEX PLUS

400 gr **5.11** 6766025



Uz silikona bāzes veidota formula visu veidu cauruļvadu eļļošanai: plastmasas, čuguna, betona, u.c., kā arī gumijas blīvju aizsardzībai jebkuros laika apstākļos.

### GEB-GEBEX TAP

20 ml **4.44** 6766040



Savienotājelementu eļļošanai. Novērš ūdeni esošā kaļķakmens nosēdumu veidošanos uz eļļotajām virsmām.

### Mastika baseiniem

balta 290 ml 590910 **15.99** 6766043  
caurspīdīga 290 ml 590911 **15.99** 6766044



Neitrāla vienkomponenta polimēru mastika uz modificēta silikona bāzes. Paredzēts noplūžu līmēšanai, savienošanai un blīvēšanai iekšējās, ārējās un zem ūdens.

Paredzēts īpaši peldbaseiniem, spa un balneoterapijas zonām. Piemērots gadījumiem, kad nepieciešama materiāla paaugstināta stabilitāte zem ūdens. Tam ir augsta sākotnējā saķere, tāpēc bieži vien nav nepieciešama balstu un pastiprinājumu uzstādīšana. Hidroizolācija (ūdens attīrīšanas ierīces, prožektoru, caurules, apmalītes, siltumnīcas, segumi utt.)

### GEB-GEBETANCHE+

75ml **21.73** 6766013













Universālie anarobie sveķi paredzēti metāla vītņu savienojumiem jebkuriem izplatītajiem nesējiem. Jaunā tehnoloģija paredzēta ātrai, tīrai un ekonomiskai metāla vītņu montāžai. Lietojams bez līmiem. Viena tūbiņa paredzēta 100 savienojumiem ar izm. 1"













Paredzēta aukstā un karstā ūdens sistēmās, apkures sistēmās, gāzes apgādes sistēmās, ogļskābās gāzes padeves sistēmās, apkures sistēmās (butāns, propāns, dīzeldegviela, mazuts u.c.)











\* Ieteicams lietot dzeramajam ūdenim (klasifikācijas WRAS, standarts BS 6920).  
\* Temperatūras izturība: no -30°C līdz +130°C, +150°C pie īslaicīgas uzkaršanas.  
\* Spiedienu izturība >170 bar.







VEIKALS  
EUR











VEIKALS  
EUR

	<p><i>Remontlenta caurulēm</i> 1,5*0,05m <b>16.97 6766024</b></p> <p>Paredzēts dažādu plaisu, caurumu un citu bojājumu ātram remontam. Lietojams tikai uz cietām, nelokāmām virsmām. Plaši pielietojams apkures, kanalizācijas un citu sistēmu remontam. Derīgs uz mitrām virsmāk, kā arī iegremdētām ūdenī (max 1m). Žūšanas laiks 30min. Spiediena izt. max 20 Bar; Temp. max izturība 125°C</p>	 <p><i>Dezinfekcijas līdzeklis kondicionieriem G95</i> 850410 1l <b>13.19 6772029</b> 5l</p>
	<p><b>GEB PRETAPOSER</b> Stūra montāžas lente</p> <p>40mm*3,35m <b>19.52 6766021</b></p>	 <p><i>Aizsarglīdzeklis pret koroziju, kaļķakmeni apkures sistēmā G11</i> 871130 1l <b>37.27 6772022</b></p>
	<p><i>Vannas istabas tīrīšanas līdzeklis</i> 500 ml <b>4.44 8272003</b></p> <p>Paredzēts porcelāna un keramikas flīžu, izlietņu, jaucējkrānu, dušas galviņu, tualetšu utt. regulārai tīrīšanai. Viegli noņem visgrūtākās kaļķa nogulsnes un nodrošina virsmu ar dabisku spīdumu. Efektīvi notīra netīrumus, ziepju un ūdens nogulsnes. Lietošanas instrukcija: pagrieziet dozatoru uz SPRAY pozīciju. Izsmidzināt tieši uz virsmas no 15-20 cm attālumaļaujiet līdzeklim 2-3 minūtes iedarboties. Nosalucīt ar mitru drānu vai noskalot ar ūdeni. Uzglabāt oriģinālajā iepakojumā! Sargāt no bērniem! Glabāšanas temperatūra 5°C - 25°C</p>	<p><i>Nogulšņu noņemšanai esošās apkures sistēmās G30</i></p>  <p>1l <b>18.48 6772030</b></p>
	<p><i>Pasta vītņu blīvēšanai saules paneļos</i> 250 gr. <b>9.05 6766039</b></p>	<p><i>Degļu un filtru tīrīšanas līdzeklis G80</i></p>  <p>500 ml <b>14.58 6772031</b></p>
	<p>105579 <i>Līdzeklis sūces novēršanai G40</i> 2l <b>33.66 6772024</b></p>	<p>512369 <i>Apakšējā durvju gumija 5-8 mm biezam stiklam</i></p>  <p>1 m <b>10.27 6774001</b></p>
		<p>512368 <i>Gumija dušas kabīnes stiklam, vertikāli 5-8 mm biezam stiklam</i></p>  <p>2 m <b>17.36 6774000</b></p>
		<p>873016 <i>Lokanais pievads radiatoru uzpildei</i></p>  <p><b>12.95 6735007</b></p>













		GAB.	EUR	VEIKALS
	<b>1000G</b>	<i>Stucēris ar ārējo vītņi</i>		
	1/4"x10	25	<b>0.94</b>	<b>0925342</b>
	3/8"x10	25	<b>1.28</b>	<b>0925343</b>
	3/8"x13	25	<b>1.28</b>	<b>0925344</b>
	1/2"x10	25	<b>1.61</b>	<b>0925092</b>
	1/2"x13	25	<b>1.61</b>	<b>0925093</b>
	1/2"x15	25	<b>1.61</b>	<b>0925100</b>
	1/2"x18	10	<b>1.67</b>	<b>0925345</b>
	1/2"x20	10	<b>1.61</b>	<b>0925269</b>
	3/4"x20	10	<b>2.70</b>	<b>0925101</b>
	3/4"x25	10	<b>2.82</b>	<b>0925270</b>
	1"x20	10	<b>3.67</b>	<b>0925292</b>
	1"x25	10	<b>3.88</b>	<b>0925094</b>
	1,1/4"x32	5	<b>6.72</b>	<b>0925242</b>
1,1/2"x40	5	<b>11.87</b>	<b>0925243</b>	
2"x50	5	<b>16.13</b>	<b>0925244</b>	
	<b>1001G</b>	<i>Stucēris ar iekšējo vītņi</i>		
	1/4"x10	25	<b>0.97</b>	<b>0925346</b>
	3/8"x10	25	<b>1.47</b>	<b>0925347</b>
	1/2"x10	25	<b>1.84</b>	<b>0925095</b>
	1/2"x13	25	<b>1.86</b>	<b>0925096</b>
	1/2"x15	25	<b>1.88</b>	<b>0925097</b>
	1/2"x18	10	<b>2.08</b>	<b>0925348</b>
	1/2"x20	10	<b>1.88</b>	<b>0925271</b>
	3/4"x20	10	<b>2.84</b>	<b>0925098</b>
	3/4"x25	10	<b>2.96</b>	<b>0925272</b>
	1"x25	10	<b>4.31</b>	<b>0925099</b>
	1,1/4"x32	5	<b>9.79</b>	<b>0925245</b>
	1,1/2"x40	5	<b>13.46</b>	<b>0925246</b>
	2"x50	5	<b>24.19</b>	<b>0925247</b>
	<b>1002G</b>	<i>Stucēris divpusējs (eģlīte)</i>		
	1/2"	25	<b>2.03</b>	<b>0925297</b>
	3/4"	25	<b>2.68</b>	<b>0925298</b>
	1"	10	<b>3.98</b>	<b>0925299</b>
	<b>670</b>	<i>Stucēris ar iekšējo vītņi (hromēts)</i>		
	3/4"x15		<b>1.26</b>	<b>0921127</b>
	<b>1700G</b>	<i>Piecgabals (90mm)</i>		
	1"x20		<b>3.67</b>	<b>0921128</b>
	<b>1790G</b>	<i>Kontruzgriezņš ar apmali</i>		
	1/2"	25	<b>1.67</b>	<b>0925108</b>
	3/4"	25	<b>1.72</b>	<b>0925109</b>
	1"	10	<b>2.60</b>	<b>0925262</b>
	1,1/4"	10	<b>3.47</b>	<b>0925294</b>
	<b>1791G</b>	<i>Kontruzgriezņš</i>		
	1/2"	50	<b>0.98</b>	<b>0925190</b>
	3/4"	50	<b>1.11</b>	<b>0925191</b>
	<b>3660C</b>	<i>Trīsdalīgs līkums radiatoriem (hromēts)</i>		
	1/2"	10	<b>6.01</b>	<b>0921044</b>
	3/4"	10	<b>8.32</b>	<b>0921045</b>
	1"		<b>13.23</b>	<b>0921046</b>
	<b>3660G</b>	<i>Trīsdalīgs līkums radiatoriem</i>		
	1/2"	10	<b>5.44</b>	<b>0925326</b>
	3/4"	10	<b>10.31</b>	<b>0925327</b>
	1"		<b>13.10</b>	<b>0925328</b>
	1,1/4"		<b>21.76</b>	<b>0925329</b>
	<b>3661C</b>	<i>Taisns trīsdalīgs savienojums (hromēts)</i>		
	1/2"	10	<b>4.47</b>	<b>0921047</b>
	3/4"	10	<b>5.98</b>	<b>0921048</b>
	1"		<b>10.12</b>	<b>0921049</b>
	<b>3661G</b>	<i>Taisns trīsdalīgs savienojums</i>		
	1/2"	10	<b>4.14</b>	<b>0925330</b>
	3/4"	10	<b>6.55</b>	<b>0925331</b>
	1"		<b>11.43</b>	<b>0925332</b>
	1,1/4"		<b>20.19</b>	<b>0925333</b>
	<b>5003G</b>	<i>Pāreja- saskrūve</i>		
	1"x1,1/2"	2	<b>7.05</b>	<b>0925152</b>
	1,1/4"x2"	2	<b>12.50</b>	<b>0925153</b>
	<b>7403G</b>	<i>Taisns trīsdalīgs savienojums</i>		
	1/2"x1/2"	10	<b>5.14</b>	<b>0925260</b>
	3/4"x3/4"	10	<b>7.40</b>	<b>0925263</b>
	1"x1"		<b>11.25</b>	<b>0925261</b>

		GAB.	EUR	VEIKALS
	<b>4025</b>	<i>Saskrūve ar pretvārstu</i>		
	3/4"		<b>11.05</b>	<b>0925315</b>
	<b>7500G</b>	<i>Trīsdalīgs savienojums ar gumijas blīvi</i>		
	1/2"	10	<b>8.14</b>	<b>0925159</b>
	3/4"	5	<b>12.50</b>	<b>0925160</b>
	1"	5	<b>14.00</b>	<b>0925161</b>
	1,1/4"	5	<b>26.05</b>	<b>0925310</b>
	1,1/2"		<b>36.47</b>	<b>0925311</b>
	<b>5006G</b>	<i>Ūdens skaitītāja pieslēguzgriezņš</i>		
	1/2"x3/4"	10	<b>3.14</b>	<b>0925225</b>
	3/4"x1"	5	<b>6.31</b>	<b>0925162</b>
	1"X1,1/4"	5	<b>10.98</b>	<b>0925164</b>
	<b>5200C</b>	<i>Pāreja ar ārējām vītņēm (hromēta)</i>		
	3/8"x1/2"	25	<b>1.61</b>	<b>0921001</b>
	<b>5200G</b>	<i>Pāreja ar ārējām vītņēm</i>		
	1/8"X1/4"	25	<b>0.89</b>	<b>0925248</b>
	1/4"x3/8"	25	<b>0.98</b>	<b>0925226</b>
	1/4"x1/2"	25	<b>1.26</b>	<b>0925104</b>
	3/8"x1/2"	25	<b>1.26</b>	<b>0925001</b>
	1/2"x3/4"	10	<b>1.79</b>	<b>0925002</b>
	1/2"x1"	10	<b>2.88</b>	<b>0925003</b>
	3/4"x1"	10	<b>2.93</b>	<b>0925004</b>
	3/4"x1,1/4"	10	<b>4.38</b>	<b>0925005</b>
	1"x1,1/4"	10	<b>4.51</b>	<b>0925006</b>
	1"x1,1/2"	10	<b>6.89</b>	<b>0925007</b>
	1"x2"	5	<b>11.18</b>	<b>0925188</b>
	1,1/4"x1,1/2"	5	<b>7.26</b>	<b>0925008</b>
	1,1/4"x2"	5	<b>11.91</b>	<b>0925120</b>
1,1/2"x2"	5	<b>11.39</b>	<b>0925009</b>	
	<b>5300C</b>	<i>Pāreja ar ārējām vītņēm (hromēta)</i>		
	1/8"	25	<b>0.59</b>	<b>0921124</b>
	3/8"	25	<b>1.14</b>	<b>0921120</b>
	1/2"	25	<b>1.28</b>	<b>0921003</b>
	3/4"	10	<b>1.95</b>	<b>0921004</b>
	<b>5300G</b>	<i>Pāreja ar ārējām vītņēm</i>		
	1/8"	25	<b>0.54</b>	<b>0925293</b>
	1/4"	25	<b>0.78</b>	<b>0925112</b>
	3/8"	25	<b>0.96</b>	<b>0925010</b>
	1/2"	25	<b>1.13</b>	<b>0925011</b>
	3/4"	10	<b>1.46</b>	<b>0925102</b>
	1"	10	<b>2.55</b>	<b>0925012</b>
1,1/4"	10	<b>4.65</b>	<b>0925013</b>	
	<b>5500C</b>	<i>Vītņu pāreja (I-Ā) (hromēta)</i>		
	3/8"x1/2"		<b>0.81</b>	<b>0921077</b>
	1/2"x3/4"		<b>1.06</b>	<b>0921053</b>
		<b>5600C</b>	<i>Vītņu pāreja (I-Ā) (hromēta)</i>	
3/8"x1/2"		25	<b>1.16</b>	<b>0921006</b>
1/2"x3/4"		25	<b>1.53</b>	<b>0921007</b>
1"x1,1/4"		10	<b>5.43</b>	<b>0921119</b>
	<b>5600G</b>	<i>Vītņu pāreja (I-Ā)</i>		
	1/8"X1/4"	25	<b>0.75</b>	<b>0925103</b>
	1/8"X3/8"	25	<b>0.93</b>	<b>0925194</b>
	1/4"x3/8"	25	<b>0.96</b>	<b>0925227</b>
	1/4"x1/2"	25	<b>1.21</b>	<b>0925105</b>
	3/8"x1/2"	25	<b>0.97</b>	<b>0925016</b>
	1/2"x3/4"	25	<b>1.07</b>	<b>0925017</b>
	1/2"x1"	10	<b>2.51</b>	<b>0925018</b>
	1/2"X1,1/4"	10	<b>5.28</b>	<b>0925020</b>
	3/4"X1"	10	<b>2.07</b>	<b>0925019</b>
	3/4"x1,1/4"	10	<b>4.29</b>	<b>0925021</b>
	3/4"x1,1/2"	10	<b>6.43</b>	<b>0925023</b>
	1"x1,1/4"	10	<b>3.60</b>	<b>0925022</b>
	1"x1,1/2"	10	<b>5.73</b>	<b>0925024</b>
	1"x2"	5	<b>10.87</b>	<b>0925026</b>
	1,1/4"x1,1/2"	5	<b>4.58</b>	<b>0925025</b>
1,1/4"x2"		<b>8.66</b>	<b>0925027</b>	
1,1/2"x2"		<b>8.56</b>	<b>0925028</b>	

		GAB.	EUR	VEIKALS		
	<b>5700C</b>	<i>Korkis ar iekšējo vītņi (hromēts)</i>				
		1/2"	25	<b>1.09 0921008</b>		
		3/4"	25	<b>1.61 0921009</b>		
	<b>5700G</b>	<i>Korkis ar iekšējo vītņi</i>				
		1/4"	25	<b>0.79 0925113</b>		
		3/8"	25	<b>0.72 0925029</b>		
		1/2"	25	<b>0.91 0925030</b>		
		3/4"	25	<b>1.10 0925031</b>		
		1"	10	<b>1.77 0925032</b>		
		1,1/4"	10	<b>3.09 0925033</b>		
		1,1/2"	10	<b>4.13 0925034</b>		
	<b>5803C</b>	<i>Korkis ar ārējo vītņi (hromēts)</i>				
		1/2"	25	<b>1.03 0921010</b>		
		3/4"	25	<b>1.61 0921011</b>		
	<b>5803G</b>	<i>Korkis ar ārējo vītņi</i>				
		1/4"	25	<b>0.66 0925114</b>		
		3/8"	25	<b>0.82 0925115</b>		
		1/2"	25	<b>1.07 0925035</b>		
		3/4"	25	<b>1.61 0925036</b>		
		1"	10	<b>2.70 0925037</b>		
		1,1/4"	10	<b>4.18 0925038</b>		
		1,1/2"	10	<b>5.98 0925039</b>		
	<b>6003C</b>	<i>Pagarinātājs (hromēts)</i>				
		1/2"x10	25	<b>1.60 0921012</b>		
		1/2"x15	25	<b>2.10 0921051</b>		
		1/2"x20	10	<b>2.37 0921013</b>		
		1/2"x25	10	<b>2.81 0921122</b>		
		1/2"x30	10	<b>3.08 0921014</b>		
		1/2"x40	10	<b>3.72 0921015</b>		
		1/2"x50	10	<b>4.60 0921016</b>		
		1/2"x65	10	<b>5.49 0921017</b>		
		1/2"x80	10	<b>11.03 0921125</b>		
		1/2"x100	10	<b>14.07 0921126</b>		
		3/4"x10	25	<b>2.23 0921115</b>		
		3/4"x20	25	<b>2.95 0921116</b>		
		3/4"x30	10	<b>3.94 0921018</b>		
		3/4"x40	10	<b>5.00 0921117</b>		
		3/4"x50	10	<b>5.72 0921019</b>		
		1"x10	10	<b>3.51 0921078</b>		
		1"x15	10	<b>3.98 0921079</b>		
		1"x20	10	<b>4.60 0921080</b>		
		1"x25	10	<b>5.28 0921081</b>		
		1"x30	10	<b>6.00 0921082</b>		
		1"x40	5	<b>7.42 0921083</b>		
		1"x50	5	<b>8.98 0921084</b>		
			<b>6003G</b>	<i>Pagarinātājs</i>		
				1/2"x10	25	<b>1.40 0925041</b>
1/2"x15	25			<b>1.74 0925042</b>		
1/2"x20	10			<b>2.03 0925043</b>		
1/2"x25	10			<b>2.23 0925233</b>		
1/2"x30	10			<b>2.58 0925044</b>		
1/2"x40	10			<b>3.26 0925045</b>		
1/2"x50	10			<b>4.10 0925046</b>		
1/2"x65	10			<b>4.70 0925047</b>		
1/2"x80	10			<b>7.77 0925234</b>		
1/2"x100	10			<b>9.47 0925235</b>		
3/4"x10	10			<b>2.03 0925048</b>		
3/4"x15	10			<b>3.04 0925304</b>		
3/4"x20	10			<b>2.84 0925049</b>		
3/4"x30	10			<b>3.63 0925050</b>		
3/4"x40	10			<b>4.44 0925051</b>		
3/4"x50	10			<b>4.93 0925052</b>		
3/4"x60	10			<b>9.99 0925305</b>		
3/4"x80	10			<b>12.68 0925306</b>		
1"x20	10			<b>4.23 0925229</b>		
1"x25	10			<b>5.21 0925163</b>		
1"x30	10			<b>5.42 0925230</b>		
1"x40	5			<b>6.26 0925231</b>		
1"x50	5			<b>7.58 0925232</b>		
	<b>6006G</b>			<i>Pagarinātājs</i>		
		1/2"x10	10	<b>1.11 0925154</b>		
		1/2"x15	10	<b>1.27 0925155</b>		
		1/2"x20	10	<b>1.60 0925156</b>		
		1/2"x30	10	<b>2.21 0925157</b>		
		1/2"x40	10	<b>2.54 0925158</b>		













		GAB.	EUR	VEIKALS
	<b>6100C</b>	<i>Vītņu pāreja (A-I) (hromēta)</i>		
		3/8"x1/2"	25	<b>1.75 0921020</b>
		1/2"x3/4"	10	<b>2.26 0921021</b>
		1/2"x1"	10	<b>2.82 0921022</b>
		3/4"x1"	10	<b>3.24 0921023</b>
	<b>6100G</b>	<i>Vītņu pāreja (A-I)</i>		
		1/4"x3/8"	25	<b>1.32 0925236</b>
		1/4"x1/2"	25	<b>1.28 0925237</b>
		3/8"x1/2"	25	<b>1.67 0925193</b>
		1/2"x3/4"	10	<b>1.91 0925054</b>
	<b>6200C</b>	<i>Uzmava (hromēta)</i>		
		1/2"x1"	10	<b>2.47 0925055</b>
		3/4"x1"	10	<b>2.75 0925056</b>
		3/4"x1,1/4"	10	<b>3.84 0925110</b>
		1"x1,1/4"	10	<b>3.72 0925111</b>
		1,1/4"x1,1/2	5	<b>8.42 0925166</b>
		1,1/2"x2"	5	<b>11.29 0925167</b>
		3/8"	25	<b>1.58 0921121</b>
		1/2"	10	<b>1.98 0921024</b>
		3/4"	10	<b>2.73 0921025</b>
	<b>6200G</b>	<i>Uzmava</i>		
		1"	10	<b>4.24 0921026</b>
		1/4"		<b>0.96 0925238</b>
		3/8"		<b>1.26 0925057</b>
		1/2"	10	<b>1.68 0925058</b>
		3/4"	10	<b>2.23 0925059</b>
		1"	10	<b>3.88 0925060</b>
		1,1/4"		<b>4.84 0925061</b>
	<b>6203C</b>	<i>Uzmava ar pāreju (I-I) (hromēta)</i>		
		1,1/2"		<b>7.88 0925062</b>
		2"		<b>12.99 0925063</b>
		3/8"x1/2"	25	<b>1.81 0921027</b>
		1/2"x3/4"	10	<b>2.72 0921028</b>
		1/2"x1"	10	<b>3.77 0921029</b>
	<b>6203G</b>	<i>Uzmava ar pāreju (I-I)</i>		
		3/4"x1"	10	<b>4.60 0921030</b>
		3/4"x1,1/4"		<b>7.85 0921031</b>
		1"x1,1/4"		<b>6.91 0921032</b>
		3/8"x1/2"		<b>1.56 0925064</b>
		1/2"x3/4"	10	<b>2.23 0925065</b>
	<b>6300C</b>	<i>Līkums (I-A) (hromēts)</i>		
		1/2"x1"	10	<b>3.05 0925066</b>
		3/4"x1"	10	<b>3.72 0925069</b>
		3/4"x1,1/4"	10	<b>7.44 0925067</b>
		1"x1,1/4"		<b>6.38 0925068</b>
		1,1/4"x1,1/2"		<b>10.38 0925106</b>
		1,1/2"x2"		<b>18.99 0925107</b>
	<b>6300G</b>	<i>Līkums (I-A)</i>		
		1,1/2"		<b>20.16 0921118</b>
		3/8"	25	<b>3.09 0921033</b>
		1/2"	10	<b>3.31 0921034</b>
		3/4"	10	<b>4.93 0921050</b>
		1"		<b>7.30 0921035</b>
	<b>6303G</b>	<i>Līkums ar pāreju (I-A)</i>		
		1,1/4"		<b>11.42 0925073</b>
		1,1/2"		<b>14.63 0925119</b>
		2"		<b>27.38 0925189</b>
		1/4"	25	<b>2.19 0925239</b>
		3/8"	25	<b>2.33 0925070</b>
		1/2"	10	<b>2.46 0925071</b>
	<b>6400C</b>	<i>Līkums (I-I) (hromēts)</i>		
		3/4"	10	<b>4.40 0921038</b>
		1"		<b>7.65 0921039</b>











		GAB.	EUR	VEIKALS			GAB.	EUR	VEIKALS
	<b>6400G</b>	<i>Likums (I-I)</i>							
	1/4"	25	2.15	0925240					
	3/8"	10	2.27	0925075					
	1/2"	10	2.67	0925076					
	3/4"	10	3.67	0925077					
	1"		6.44	0925078					
	1,1/4"		10.24	0925079					
	1,1/2"		14.80	0925080					
2"		26.55	0925081						
	<b>6402G</b>	<i>Likums (A-A)</i>							
	1/2"	10	3.41	0925274					
	3/4"	10	4.86	0925275					
1"	10	8.14	0925276						
	<b>3402G</b>	<i>Likums (A-A)</i>							
	1/2"	10	3.65	0925316					
	3/4"	10	6.25	0925317					
1"	10	9.68	0925318						
	<b>6403G</b>	<i>Likums ar pāreju(I-I)</i>							
	1/2"x3/4"	10	4.31	0925195					
	1/2"x1"	10	9.01	0925196					
3/4"x1"	10	7.95	0925197						
	<b>6306G</b>	<i>Likums ar sienas stiprinājumu (I-A)</i>							
	1/2"	10	5.44	0925264					
	<b>6406G</b>	<i>Likums ar sienas stiprinājumu (I-I)</i>							
	1/2"	10	4.02	0925277					
	<b>6500C</b>	<i>Treigabals (I-I-I)(hromēts)</i>							
	3/8"	10	3.39	0921040					
	1/2"	10	3.42	0921041					
	3/4"	10	5.23	0921042					
1"		8.35	0921043						
	<b>6500G</b>	<i>Treigabals (I-I-I)</i>							
	1/4"	25	2.64	0925241					
	3/8"	10	2.76	0925082					
	1/2"	10	2.79	0925083					
	3/4"	10	3.90	0925084					
	1"		7.14	0925085					
	1,1/4"		12.17	0925086					
	1,1/2"		17.98	0925087					
2"		23.46	0925088						
	<b>6502G</b>	<i>Treigabals (A-A-A)</i>							
	1/2"	10	4.63	0925267					
	3/4"	10	4.26	0925268					
1"	10	8.26	0925291						
	<b>6510G</b>	<i>Treigabals (I-I-A)</i>							
	1/2"	10	3.00	0925278					
	3/4"	10	4.58	0925279					
1"	10	9.72	0925319						
	<b>6511G</b>	<i>Treigabals (A-I-A)</i>							
	1/2"	10	3.14	0925280					
3/4"	10	5.28	0925281						
	<b>6512G</b>	<i>Treigabals (I-A-A)</i>							
	1/2"	10	3.15	0925282					
3/4"	10	5.28	0925283						
	<b>6513G</b>	<i>Treigabals (I-A-I)</i>							
	1/2"	10	3.07	0925273					
3/4"	10	4.58	0925284						
	<b>6503G</b>	<i>Treigabals ar pāreju (I-I-I)</i>							
	3/4"x1/2"x3/4"	10	4.88	0925089					
	1"x1/2"x1"	5	8.30	0925090					
1"x3/4"x1"	5	8.26	0925091						
	<b>6506G</b>	<i>Krusts</i>							
	1/2"	10	5.10	0925118					
	3/4"	5	7.77	0925116					
1"		11.96	0925117						
	<b>1750G</b>	<i>Tvertnes starpsienu savienojums</i>							
	1/2"		6.72	0925285					
3/4"		8.65	0925286						
	<b>1760G</b>	<i>Tvertnes starpsienu savienojums</i>							
	1/2"		6.09	0925287					
3/4"		7.38	0925288						
	<b>1770G</b>	<i>Tvertnes starpsienu savienojums</i>							
	1/2"	10	4.51	0925289					
3/4"	10	5.15	0925290						
	<b>644</b>	<i>Uzmavas atzāre</i>							
	1/2"		10.00	0925320					
3/4"		13.40	0925321						
	<b>1308</b>	<i>Uzmavas atzāre</i>							
	1/2"x1/2"	16	7.96	0925322					
	1/2"x3/4"	12	9.66	0925323					
	1/2"x1"		13.86	0925324					
3/4"x1"		15.54	0925325						
	<b>7600</b>	<i>Ekscentrs (hromēts)</i>							
	1/2"x10	10	5.86	0921071					
	1/2"x20	10	8.84	0921072					
	1/2"x30	10	9.26	0921073					
	1/2"x40	10	9.52	0921074					
	1/2"x50	10	10.07	0921075					
1/2"x60	10	11.31	0921076						
	<b>6700C</b>	<i>Likums WC pieslēgšanai (hromēts)</i>							
	1/2"x1/2"		5.51	0921085					
	<b>6800C</b>	<i>Likums WC pieslēgšanai (hromēts)</i>							
	1/2"x10		6.29	0921086					
	<b>6801C</b>	<i>Likums WC pieslēgšanai (hromēts)</i>							
	1/2"x10		6.29	0921087					





GAB. EUR VEIKALS

GAB. EUR VEIKALS









	<b>6804 C</b>	<i>Līkums (IV) ar pāreju uz cauruli</i>		
	1/2"x10	10	<b>3.94</b>	<b>0921093</b>
	1/2"x12	10	<b>3.94</b>	<b>0921094</b>
	<b>6900C</b>	<i>Pāreja ārējā vītne uz cauruli (hromēta)</i>		
	1/2"x10	25	<b>2.35</b>	<b>0921065</b>
	1/2"x12	25	<b>2.34</b>	<b>0921066</b>
	<b>6901C</b>	<i>Uzmava (hromēta)</i>		
	10x10	25	<b>3.02</b>	<b>0921067</b>
	12x12	25	<b>3.16</b>	<b>0921070</b>
	<b>6902C</b>	<i>Pāreja iekšējā vītne uz cauruli (hromēta)</i>		
	1/2"x10	25	<b>2.75</b>	<b>0921068</b>
	1/2"x12	25	<b>2.95</b>	<b>0921069</b>
	<b>6904C</b>	<i>Līkums 90° (hromēts)</i>		
	10x10	10	<b>4.55</b>	<b>0921061</b>
	12x12	10	<b>4.86</b>	<b>0921113</b>
	<b>6905C</b>	<i>Trejšgabals (hromēts)</i>		
	10x10x10	10	<b>6.00</b>	<b>0921062</b>
	12x12x12	10	<b>7.15</b>	<b>0921114</b>
	<b>1176</b>	<i>Kompresijas savienojums</i>		
	3/8"x10		<b>1.85</b>	<b>0921129</b>
	<b>6906C</b>	<i>Caurule rullī 5m (hromēta)</i>		
	ø10		<b>49.91</b>	<b>0921063</b>
	ø12		<b>62.11</b>	<b>0921064</b>
	<b>18</b>	<i>Caurule taisnā (hromēta)</i>		
	ø10x100		<b>11.11</b>	<b>0921130</b>
	<b>3010G</b>	<i>Pāreja ar ārējo vītni</i>		
	1/2"x20	75	<b>3.98</b>	<b>0918001</b>
	3/4"x25	50	<b>4.95</b>	<b>0918002</b>
	1"x32	20	<b>7.75</b>	<b>0918003</b>
	1,1/4"x40	14	<b>11.60</b>	<b>0918004</b>
	1,1/2"x50	9	<b>17.42</b>	<b>0918005</b>
	2"x63	12	<b>34.63</b>	<b>0918006</b>
	<b>3011G</b>	<i>Pāreja ar iekšējo vītni</i>		
	1/2"x20	75	<b>4.05</b>	<b>0918007</b>
	3/4"x25	50	<b>5.37</b>	<b>0918008</b>
	1"x32	20	<b>8.30</b>	<b>0918009</b>
	1,1/4"x40	14	<b>12.03</b>	<b>0918010</b>
	1,1/2"x50	9	<b>17.52</b>	<b>0918011</b>
	2"x63	12	<b>35.32</b>	<b>0918012</b>
	<b>3012G</b>	<i>Uzmava</i>		
	20x20	40	<b>6.81</b>	<b>0918013</b>
	25x25	30	<b>9.05</b>	<b>0918014</b>
	32x32	18	<b>13.43</b>	<b>0918015</b>
	40x40	7	<b>19.08</b>	<b>0918016</b>
	50x50	4	<b>29.45</b>	<b>0918017</b>
	63x63		<b>60.19</b>	<b>0918018</b>

	<b>3013G</b>	<i>Līkums</i>		
	20x20	35	<b>7.73</b>	<b>0918019</b>
	25x25	20	<b>10.02</b>	<b>0918020</b>
	32x32	12	<b>15.38</b>	<b>0918021</b>
	40x40	6	<b>23.48</b>	<b>0918022</b>
	50x50	8	<b>36.52</b>	<b>0918023</b>
	63x63		<b>68.42</b>	<b>0918024</b>
	<b>3014G</b>	<i>Līkums ar iekšējo vītni</i>		
	1/2"x20	50	<b>4.88</b>	<b>0918025</b>
	3/4"x25	35	<b>6.72</b>	<b>0918026</b>
	1"x32	18	<b>10.73</b>	<b>0918027</b>
	1,1/4"x40	10	<b>16.97</b>	<b>0918028</b>
	1,1/2"x50	5	<b>28.74</b>	<b>0918029</b>
	2"x63		<b>47.56</b>	<b>0918030</b>
	<b>3015G</b>	<i>Līkums ar ārējo vītni</i>		
	1/2"x20	50	<b>5.05</b>	<b>0918031</b>
	3/4"x25	35	<b>6.79</b>	<b>0918032</b>
	1"x32	18	<b>10.47</b>	<b>0918033</b>
	1,1/4"x40	10	<b>15.78</b>	<b>0918034</b>
	1,1/2"x50	5	<b>26.22</b>	<b>0918035</b>
	2"x63		<b>49.42</b>	<b>0918036</b>
	<b>3016G</b>	<i>Trejšgabals</i>		
	20x20x20	20	<b>10.61</b>	<b>0918037</b>
	25x25x25	16	<b>13.77</b>	<b>0918038</b>
	32x32x32	8	<b>21.73</b>	<b>0918039</b>
	40x40x40	10	<b>31.34</b>	<b>0918040</b>
	50x50x50		<b>52.67</b>	<b>0918041</b>
	63x63x63		<b>99.21</b>	<b>0918042</b>
	<b>3017G</b>	<i>Trejšgabals ar iekšējo vītni</i>		
	20x1/2"x20	30	<b>7.97</b>	<b>0918043</b>
	25x3/4"x25	22	<b>10.63</b>	<b>0918044</b>
	32x1"x32	8	<b>16.58</b>	<b>0918045</b>
	40x1,1/4"x40	5	<b>25.58</b>	<b>0918046</b>
	50x1,1/2"x50	6	<b>44.21</b>	<b>0918047</b>
	63x2"x63		<b>77.34</b>	<b>0918048</b>
	<b>3018G</b>	<i>Pastiprinājums</i>		
	PP20	10	<b>0.96</b>	<b>0918049</b>
	PP25	10	<b>1.09</b>	<b>0918050</b>
	PP32	10	<b>1.32</b>	<b>0918051</b>
	PP40	10	<b>2.23</b>	<b>0918052</b>
	PP50	10	<b>3.65</b>	<b>0918053</b>
	PP63	10	<b>6.58</b>	<b>0918054</b>
	<b>3019G</b>	<i>Līkums ar sienas stiprinājumu</i>		
	1/2"x20	25	<b>6.86</b>	<b>0918055</b>
	3/4"x25	20	<b>8.18</b>	<b>0918056</b>
	1"x32	12	<b>12.57</b>	<b>0918057</b>
		<i>Polietilēna caurule PN12,5</i>		
	20x2,0;	100 m	<b>1.04</b>	<b>2518001</b>
	20x2,0;	500 m	<b>0.94</b>	<b>2518012</b>
	25x2,3;	100 m	<b>1.33</b>	<b>2518002</b>
	25x2,3;	500 m	<b>1.33</b>	<b>2518013</b>
	32x3,0;	100 m	<b>1.57</b>	<b>2518003</b>
	32x3,0;	500 m	<b>1.57</b>	<b>2518014</b>
	40x3,0;	100 m	<b>2.30</b>	<b>4218001</b>
	40x3,7;	100 m	<b>2.89</b>	<b>2518005</b>
	50x3,0;	100 m	<b>2.69</b>	<b>4218003</b>
	50x4,6;	100 m	<b>4.33</b>	<b>2518004</b>
	63x3,8;	100 m	<b>4.90</b>	<b>2518006</b>

GAB. EUR VEIKALS

<i>Bezvītnes pāreja tērauda caurulei</i>			
	<b>3100N</b>		
	1/2"	10	<b>8.14 0921095</b>
	3/4"	30	<b>10.22 0921096</b>
	1"	20	<b>14.86 0921097</b>
	1,1/4"	12	<b>22.84 0921098</b>
	1,1/2"	8	<b>27.18 0921099</b>
	2"	5	<b>39.16 0921100</b>
<i>Bezvītnes pāreja tērauda caurulei</i>			
	<b>3101N</b>		
	1/2"	10	<b>8.42 0921101</b>
	3/4"	30	<b>10.54 0921102</b>
	1"	20	<b>14.86 0921103</b>
	1,1/4"	12	<b>22.84 0921104</b>
	1,1/2"	8	<b>27.18 0921105</b>
	2"	5	<b>39.59 0921106</b>
<i>Bezvītnes uzdeva tērauda caurulei</i>			
	<b>3102N</b>		
	1/2"	10	<b>13.75 0921107</b>
	3/4"	30	<b>16.31 0921108</b>
	1"	12	<b>22.59 0921109</b>
	1,1/4"		<b>32.70 0921110</b>
	1,1/2"	6	<b>35.95 0921111</b>
	2"	4	<b>57.61 0921112</b>
<i>Montāžas plāksne jaucējkrānam</i>			
<b>4476 B/2</b>		20	<b>1.47 0925335</b>
<i>Montāžas plāksne jaucējkrānam</i>			
<b>4476 B/3</b>		20	<b>2.26 0925336</b>
<i>Montāžas plāksne ar 2 līkumiem</i>			
<b>4476 C/6</b>		20	<b>9.26 0925337</b>
<i>Montāžas plāksne ar 2 līkumiem</i>			
<b>4476 C/7</b>		20	<b>8.57 0925339</b>
	<b>DS IBC</b>		<i>Tvertnes vāciņš</i>
	1/2"		<b>2.50 2363107</b>
	3/4"		<b>2.50 2363105</b>
	1"		<b>2.50 2363106</b>
<i>Cenas par vienu gab., bez dārza krāna</i>			

GAB. EUR VEIKALS

<b>7100G</b>				<i>Isā vītne</i>
	1/2"x50	10	<b>2.03 0925171</b>	
	1/2"x60	10	<b>2.37 0925172</b>	
	1/2"x80	10	<b>3.21 0925173</b>	
	1/2"x100	10	<b>4.02 0925174</b>	
	1/2"x120	10	<b>4.76 0925175</b>	
	1/2"x150	10	<b>6.04 0925176</b>	
	3/4"x60	10	<b>3.63 0925177</b>	
	3/4"x80	10	<b>4.76 0925178</b>	
	3/4"x100	10	<b>6.00 0925179</b>	
	3/4"x120	10	<b>7.21 0925181</b>	
	3/4"x150	10	<b>9.06 0925180</b>	
	1"x100	5	<b>7.36 0925349</b>	
1"x150	5	<b>11.66 0925350</b>		
<b>7103G</b>				<i>Garā vītne</i>
	1/2"x100	10	<b>4.56 0925182</b>	
	1/2"x150	10	<b>6.19 0925183</b>	
	1/2"x200	10	<b>9.55 0925295</b>	
	3/4"x100	10	<b>6.04 0925184</b>	
	3/4"x150	10	<b>9.07 0925185</b>	
	3/4"x200	10	<b>11.92 0925296</b>	
	1"x100	10	<b>8.26 0925186</b>	
	1"x150	10	<b>12.29 0925187</b>	
	<i>Kolektors (att. starp urb. 50mm)</i>			
<b>7050G</b>		3/4"x2	16	<b>13.82 0934002</b>
		3/4"x3	16	<b>20.04 0934003</b>
		3/4"x4	16	<b>26.46 0934004</b>
		3/4"x5	10	<b>32.84 0934005</b>
		3/4"x6	10	<b>39.14 0934006</b>
		1"x4	8	<b>29.82 0934007</b>
		1"x5	8	<b>36.80 0934008</b>
		1"x6		<b>45.36 0934009</b>
<b>3740</b>				<i>Kolektors ar ārējām vītņēm</i>
	3/4"x2		<b>7.99 0634001</b>	
	3/4"x3		<b>11.05 0634002</b>	
	3/4"x4		<b>14.44 0634003</b>	
	3/4"x5		<b>19.99 0634004</b>	
	1"x2		<b>10.62 0634005</b>	
	1"x3		<b>13.49 0634006</b>	
	1"x4		<b>18.27 0634007</b>	
	1"x5		<b>23.98 0634008</b>	
<b>7002C</b>				<i>Kolektors ar krāniem</i>
	3/4"x2		<b>14.55 0934010</b>	
	3/4"x3		<b>21.57 0934011</b>	
	3/4"x4		<b>28.90 0934012</b>	
	1"x2		<b>17.16 0934013</b>	
	1"x3		<b>25.11 0934014</b>	
	1"x4		<b>33.53 0934015</b>	
<b>3745</b>				<i>Kolektors ar krāniem</i>
	3/4"x2	5	<b>15.97 0634009</b>	
	3/4"x3	5	<b>23.97 0634010</b>	
	3/4"x4	5	<b>30.59 0634011</b>	
	1"x2	5	<b>18.23 0634012</b>	
	1"x3	5	<b>28.45 0634013</b>	
	1"x4	5	<b>37.43 0634014</b>	
<i>Kolektors ar pieslēguzgriezni</i>				
	<b>7001 MIKY</b>	3/4"x2	20	<b>21.91 0934016</b>
	3/4"x3	16	<b>29.85 0934017</b>	
	3/4"x4	10	<b>37.94 0934018</b>	
	3/4"x5	10	<b>43.81 0934019</b>	
	3/4"x6	10	<b>53.80 0934020</b>	
<b>2135 S/Z</b>				<i>Montāžas korķis</i>
	1/2"	25	<b>0.59 3936320</b>	







GAB. VEIKALS  
EURGAB. VEIKALS  
EUR







	<b>5001</b>	<i>Līkums I-Ā gar. 90°</i>		
	12	10	<b>1.03</b>	<b>7033001</b>
	15	10	<b>0.57</b>	<b>7033002</b>
	18	10	<b>1.32</b>	<b>7033003</b>
	22	10	<b>1.55</b>	<b>7033004</b>
	28	10	<b>4.38</b>	<b>7033005</b>
	35	10	<b>7.65</b>	<b>7033190</b>
	<b>5002</b>	<i>Līkums I-I gar. 90°</i>		
	12	10	<b>0.71</b>	<b>7033006</b>
	15	10	<b>0.59</b>	<b>7033007</b>
	18	10	<b>0.86</b>	<b>7033008</b>
	22	10	<b>1.33</b>	<b>7033009</b>
	28	10	<b>2.05</b>	<b>7033010</b>
	35	10	<b>7.01</b>	<b>7033191</b>
	<b>5040</b>	<i>Līkums I-Ā 45°</i>		
	12	10	<b>1.49</b>	<b>7033011</b>
	15	10	<b>0.47</b>	<b>7033012</b>
	18	10	<b>1.60</b>	<b>7033013</b>
	22	10	<b>1.55</b>	<b>7033014</b>
	28	10	<b>3.03</b>	<b>7033015</b>
	35	10	<b>6.56</b>	<b>7033202</b>
	<b>5041</b>	<i>Līkums I-I 45°</i>		
	12	10	<b>2.12</b>	<b>7033016</b>
	15	10	<b>0.59</b>	<b>7033017</b>
	18	10	<b>1.42</b>	<b>7033018</b>
	22	10	<b>1.61</b>	<b>7033019</b>
	28	10	<b>2.94</b>	<b>7033020</b>
	35	10	<b>6.21</b>	<b>7033192</b>
	<b>5085</b>	<i>Pārliiekums</i>		
	12	10	<b>4.48</b>	<b>7033021</b>
	15	10	<b>3.37</b>	<b>7033022</b>
	18	10	<b>9.37</b>	<b>7033023</b>
	22	10	<b>7.82</b>	<b>7033024</b>
	<b>5086</b>	<i>Puspārliiekums</i>		
	12	10	<b>4.02</b>	<b>7033025</b>
	15	10	<b>3.09</b>	<b>7033026</b>
	18	10	<b>4.91</b>	<b>7033027</b>
	22	10	<b>6.78</b>	<b>7033028</b>
	<b>5090</b>	<i>Līkums I-I 90°</i>		
	12	10	<b>0.62</b>	<b>7033029</b>
	15	10	<b>0.50</b>	<b>7033030</b>
	18	10	<b>0.71</b>	<b>7033031</b>
	22	10	<b>1.16</b>	<b>7033032</b>
	28	10	<b>2.14</b>	<b>7033033</b>
	35	10	<b>8.56</b>	<b>7033193</b>
	<b>5092</b>	<i>Līkums I-Ā 90°</i>		
	12	10	<b>0.82</b>	<b>7033034</b>
	15	10	<b>0.63</b>	<b>7033035</b>
	18	10	<b>1.31</b>	<b>7033036</b>
	22	10	<b>2.23</b>	<b>7033037</b>
	28	10	<b>3.48</b>	<b>7033038</b>
	35	10	<b>8.48</b>	<b>7033194</b>

















	<b>5130</b>	<i>Treigabals</i>		
	12	10	<b>1.30</b>	<b>7033039</b>
	15	10	<b>0.79</b>	<b>7033040</b>
	18	10	<b>1.50</b>	<b>7033041</b>
	22	10	<b>2.61</b>	<b>7033042</b>
	28	10	<b>4.86</b>	<b>7033043</b>
	35	10	<b>12.66</b>	<b>7033203</b>
	<b>5130</b>	<i>Treigabals-pāreja</i>		
	15*12*12	10	<b>1.51</b>	<b>7033044</b>
	15*12*15	10	<b>1.19</b>	<b>7033045</b>
	15*15*12	10	<b>1.93</b>	<b>7033046</b>
	15*18*15	10	<b>2.94</b>	<b>7033047</b>
	15*22*15	10	<b>3.85</b>	<b>7033048</b>
	18*12*12	10	<b>4.23</b>	<b>7033049</b>
	18*12*15	10	<b>7.61</b>	<b>7033050</b>
	18*12*18	10	<b>3.31</b>	<b>7033051</b>
	18*15*12	10	<b>4.85</b>	<b>7033052</b>
	18*15*15	10	<b>1.42</b>	<b>7033053</b>
	18*15*18	10	<b>1.76</b>	<b>7033054</b>
	18*18*12	10	<b>4.04</b>	<b>7033055</b>
	18*18*15	10	<b>1.71</b>	<b>7033056</b>
	18*22*18	10	<b>4.02</b>	<b>7033057</b>
	22*12*18	10	<b>6.91</b>	<b>7033058</b>
	22*12*22	10	<b>2.57</b>	<b>7033059</b>
	22*15*15	10	<b>2.61</b>	<b>7033060</b>
	22*15*18	10	<b>4.49</b>	<b>7033061</b>
	22*15*22	10	<b>2.10</b>	<b>7033062</b>
	22*18*15	10	<b>5.74</b>	<b>7033063</b>
	22*18*18	10	<b>3.11</b>	<b>7033064</b>
	22*18*22	10	<b>3.39</b>	<b>7033065</b>
22*22*15	10	<b>6.16</b>	<b>7033066</b>	
22*22*18	10	<b>7.23</b>	<b>7033067</b>	
28*15*15	10	<b>7.03</b>	<b>7033068</b>	
28*15*22	10	<b>6.80</b>	<b>7033069</b>	
28*15*28	10	<b>5.07</b>	<b>7033070</b>	
28*18*15	10	<b>12.66</b>	<b>7033071</b>	
28*18*18	10	<b>18.33</b>	<b>7033072</b>	
28*18*22	10	<b>6.78</b>	<b>7033073</b>	
28*18*28	10	<b>8.25</b>	<b>7033074</b>	
28*22*15	10	<b>10.75</b>	<b>7033075</b>	
28*22*18	10	<b>6.76</b>	<b>7033076</b>	
28*22*22	10	<b>5.54</b>	<b>7033077</b>	
28*22*28	10	<b>5.15</b>	<b>7033078</b>	
28*28*15	10	<b>10.65</b>	<b>7033079</b>	
28*28*18	10	<b>9.23</b>	<b>7033080</b>	
28*28*22	10	<b>7.33</b>	<b>7033081</b>	
35*22*22	10	<b>19.55</b>	<b>7033208</b>	
35*28*35	10	<b>12.66</b>	<b>7033195</b>	
35*35*28	10	<b>21.11</b>	<b>7033209</b>	

GAB. EUR VEIKALS

GAB. EUR VEIKALS

	<b>5243</b>		<i>Mufe ar pāreju I-Ā</i>	
	15*12	10	<b>0.72</b>	<b>7033082</b>
	18*12	10	<b>0.70</b>	<b>7033083</b>
	18*15	10	<b>0.64</b>	<b>7033084</b>
	22*12	10	<b>1.57</b>	<b>7033085</b>
	22*15	10	<b>1.15</b>	<b>7033086</b>
	22*18	10	<b>1.22</b>	<b>7033087</b>
	28*15	10	<b>4.24</b>	<b>7033088</b>
	28*18	10	<b>4.77</b>	<b>7033089</b>
	28*22	10	<b>1.94</b>	<b>7033090</b>
	<b>5240</b>		<i>Mufe ar pāreju I-I</i>	
	15*12	10	<b>1.06</b>	<b>7033091</b>
	18*12	10	<b>0.95</b>	<b>7033092</b>
	18*15	10	<b>0.90</b>	<b>7033093</b>
	22*15	10	<b>2.41</b>	<b>7033094</b>
	22*18	10	<b>1.50</b>	<b>7033095</b>
	28*15	10	<b>2.97</b>	<b>7033096</b>
	28*18	10	<b>2.93</b>	<b>7033097</b>
	28*22	10	<b>2.37</b>	<b>7033098</b>
	35*22	10	<b>5.93</b>	<b>7033196</b>
	<b>5270</b>		<i>Mufe</i>	
	12	10	<b>0.33</b>	<b>7033099</b>
	15	10	<b>0.32</b>	<b>7033100</b>
	18	10	<b>0.40</b>	<b>7033101</b>
	22	10	<b>0.64</b>	<b>7033102</b>
	28	10	<b>1.52</b>	<b>7033103</b>
	35	10	<b>3.41</b>	<b>7033197</b>
	<b>5301</b>		<i>Korķis</i>	
	12	10	<b>1.17</b>	<b>7033104</b>
	15	10	<b>0.92</b>	<b>7033105</b>
	18	10	<b>1.10</b>	<b>7033106</b>
	22	10	<b>1.93</b>	<b>7033107</b>
	28	10	<b>3.61</b>	<b>7033108</b>
	35	10	<b>9.27</b>	<b>7033204</b>
	<i>Kapara caurule cietā 5 m (1 mm)</i>			
	99B12		<b>8.47</b>	<b>7033214</b>
	99B15		<b>13.72</b>	<b>7033215</b>
	99B18		<b>16.79</b>	<b>7033216</b>
	99B22		<b>21.56</b>	<b>7033217</b>
	99B28		<b>28.84</b>	<b>7033218</b>
	99B35		<b>37.01</b>	<b>7033219</b>
		<i>Kapara caurule mīkstā rullī 25m</i>		
99A10		50	<b>6.04</b>	<b>7033211</b>
99A12		50	<b>7.23</b>	<b>7033212</b>
99A15		25	<b>8.43</b>	<b>7033213</b>
	<i>Birstūte kapara cauruļu tīrīšanai</i>			
	15mm	12	<b>4.15</b>	<b>1735002</b>
	18mm	12	<b>3.84</b>	<b>1735003</b>
	22mm	12	<b>4.02</b>	<b>1735004</b>
	28mm	12	<b>5.85</b>	<b>1735005</b>

	<b>5001C</b>		<i>Svammīte cauruļu tīrīšanai</i>	
	10		<b>5.02</b>	<b>1735001</b>
	<b>331184</b>		<i>PE cauruļu gala frēze</i>	
	20-63 mm		<b>19.06</b>	<b>2535030</b>
	<b>4476C/7</b>		<i>Montāžas plāksne</i>	
	1/2"*15mm	20	<b>8.57</b>	<b>0925339</b>
	<i>Alva lodēšanai SN9</i>			
	100 gr	815708	<b>20.88</b>	<b>6735004</b>
	<i>Kusnis lodēšanai ar alvu "HAMPTON"</i>			
	Kusnis lodēšanai ar alvu. Satur cinka hlorīdu. Paredzēts dzelzs, tērauda, čuguna, vara, bronzas, misiņa, cinka u.c. metālu lodēšanai izņemot alumīniju! Aktivizējas pie +75°C līdz +375°C.			
175 gr	100111	<b>11.48</b>	<b>6735002</b>	
<i>Cauruļu izolācija</i>				
	<b>110022</b>	15/9	<b>0.53</b>	<b>3081001</b>
	<b>110042</b>	18/9	<b>0.55</b>	<b>3081002</b>
	<b>110062</b>	22/9	<b>0.59</b>	<b>3081003</b>
		25/9	<b>0.71</b>	<b>3081013</b>
	<b>110101</b>	28/9	<b>0.71</b>	<b>3081004</b>
	<b>110142</b>	35/9	<b>0.80</b>	<b>3081005</b>
	<b>110159</b>	42/9	<b>0.95</b>	<b>3081008</b>
	<b>110172</b>	48/9	<b>1.15</b>	<b>3081010</b>
	<b>110201</b>	54/9	<b>1.39</b>	<b>3081009</b>
	<b>110246</b>	60/9	<b>1.43</b>	<b>3081006</b>
	<b>110225</b>	76/9	<b>3.43</b>	<b>3081007</b>
		15/13		
		18/13		
	<b>82012022</b>	22/13	<b>0.94</b>	<b>5081001</b>
	<b>82013028</b>	28/13	<b>1.11</b>	<b>5081002</b>
<b>82013035</b>	35/13	<b>1.49</b>	<b>5081003</b>	
<b>82013042</b>	42/13	<b>1.53</b>	<b>5081004</b>	
	48/13			
<b>82013054</b>	54/13	<b>2.01</b>	<b>5081008</b>	
<b>82013063</b>	63/13	<b>2.40</b>	<b>5081005</b>	
<i>Auduma, mitrumizturīga limenta, pelēka (Folsen)</i>				
	48mmx50m		<b>8.06</b>	<b>2566019</b>
	50mmx50m		<b>6.94</b>	<b>2566021</b>









	<b>4090G</b>	<i>Līkums IV 90°</i>			
	12*1/2"	10	<b>1.67</b>	<b>7033109</b>	
	15*1/2"	10	<b>2.29</b>	<b>7033110</b>	
	15*3/4"	10	<b>2.35</b>	<b>7033111</b>	
	18*1/2"	10	<b>3.07</b>	<b>7033112</b>	
	18*3/4"	10	<b>4.66</b>	<b>7033113</b>	
	22*1/2"	10	<b>2.94</b>	<b>7033114</b>	
	22*3/4"	10	<b>5.17</b>	<b>7033115</b>	
	22*1"	10	<b>7.14</b>	<b>7033116</b>	
	28*3/4"	10	<b>8.38</b>	<b>7033117</b>	
28*1"	10	<b>8.69</b>	<b>7033118</b>		
	<b>4092G</b>	<i>Līkums AV 90°</i>			
	12*1/2"	10	<b>2.08</b>	<b>7033119</b>	
	15*1/2"	10	<b>2.17</b>	<b>7033120</b>	
	18*1/2"	10	<b>3.93</b>	<b>7033121</b>	
	15*3/4"	10	<b>4.59</b>	<b>7033122</b>	
	18*3/4"	10	<b>5.54</b>	<b>7033123</b>	
	22*3/4"	10	<b>5.71</b>	<b>7033124</b>	
	22*1"	10	<b>9.14</b>	<b>7033125</b>	
28*1"	10	<b>7.88</b>	<b>7033126</b>		
	<b>4096G</b>	<i>Lod. savienojums ar piesl. IV</i>			
	15*1/2"	10	<b>4.68</b>	<b>7033127</b>	
	18*1/2"	10	<b>10.68</b>	<b>7033128</b>	
	22*3/4"	10	<b>19.87</b>	<b>7033129</b>	
28*1"	10	<b>20.41</b>	<b>7033130</b>		
	<b>4098G</b>	<i>Lod. savienojums ar piesl. AV</i>			
	15*1/2"	10	<b>2.86</b>	<b>7033131</b>	
	18*1/2"	10	<b>8.18</b>	<b>7033132</b>	
	22*3/4"	10	<b>8.91</b>	<b>7033133</b>	
28*1"	10	<b>10.61</b>	<b>7033134</b>		
	<b>4130G</b>	<i>Trejgabals IV</i>			
	12*1/2"*12	10	<b>2.40</b>	<b>7033135</b>	
	15*1/2"*15	10	<b>2.03</b>	<b>7033136</b>	
	15*3/4"*15	10	<b>6.62</b>	<b>7033137</b>	
	18*1/2"*18	10	<b>3.74</b>	<b>7033138</b>	
	18*3/4"*18	10	<b>4.13</b>	<b>7033139</b>	
	22*1/2"*22	10	<b>8.46</b>	<b>7033140</b>	
	22*3/4"*22	10	<b>6.05</b>	<b>7033141</b>	
	28*1/2"*28	10	<b>7.78</b>	<b>7033142</b>	
28*3/4"*28	10	<b>14.86</b>	<b>7033143</b>		
28*1"*28	10	<b>14.76</b>	<b>7033144</b>		
	<b>4243G</b>	<i>Pāreja AV</i>			
	10*3/8	10	<b>4.03</b>	<b>7033206</b>	
	12*1/2"	10	<b>1.60</b>	<b>7033145</b>	
	15*1/2"	10	<b>1.13</b>	<b>7033146</b>	
	15*3/4"	10	<b>1.55</b>	<b>7033147</b>	
	18*1/2"	10	<b>1.52</b>	<b>7033148</b>	
	18*3/4"	10	<b>1.86</b>	<b>7033149</b>	
	22*1/2"	10	<b>2.89</b>	<b>7033150</b>	
	22*3/4"	10	<b>2.25</b>	<b>7033151</b>	
	22*1"	10	<b>2.80</b>	<b>7033152</b>	
	28*3/4"	10	<b>4.95</b>	<b>7033153</b>	
	28*1"	10	<b>3.24</b>	<b>7033154</b>	
35*1"	10	<b>7.00</b>	<b>7033198</b>		
35*1 1/4"	10	<b>5.79</b>	<b>7033199</b>		
	<b>4340</b>	<i>Lod. savienojums ar piesl.</i>			
	12	10	<b>4.55</b>	<b>7033155</b>	
	15	10	<b>6.96</b>	<b>7033156</b>	
	18	10	<b>8.12</b>	<b>7033157</b>	
	22	10	<b>12.69</b>	<b>7033158</b>	
28	10	<b>21.82</b>	<b>7033159</b>		
	<b>4472G</b>	<i>Līkums ar sienas stiprinājumu</i>			
	12*1/2"	10	<b>3.20</b>	<b>7033186</b>	
	15*1/2"	10	<b>2.11</b>	<b>7033187</b>	
	18*1/2"	10	<b>2.28</b>	<b>7033188</b>	
22*3/4"	10	<b>5.32</b>	<b>7033189</b>		
	<b>4270G</b>	<i>Pāreja IV</i>			
	12*1/2"	10	<b>2.24</b>	<b>7033160</b>	
	15*1/2"	10	<b>1.61</b>	<b>7033161</b>	
	15*3/4"	10	<b>4.45</b>	<b>7033162</b>	
	18*1/2"	10	<b>2.20</b>	<b>7033163</b>	
	18*3/4"	10	<b>3.71</b>	<b>7033164</b>	
	22*1/2"	10	<b>3.12</b>	<b>7033165</b>	
	22*3/4"	10	<b>3.19</b>	<b>7033166</b>	
22*1"	10	<b>4.17</b>	<b>7033167</b>		
28*3/4"	10	<b>6.28</b>	<b>7033168</b>		
28*1"	10	<b>4.80</b>	<b>7033169</b>		
35*1"	10	<b>9.76</b>	<b>7033200</b>		
35*1 1/4"	10	<b>9.24</b>	<b>7033201</b>		
	<b>4340G</b>	<i>Lod. savienojums ar piesl. IV</i>			
	12*1/2"	10	<b>10.41</b>	<b>7033170</b>	
	15*1/2"	10	<b>8.34</b>	<b>7033171</b>	
	15*3/4"	10	<b>9.86</b>	<b>7033172</b>	
	18*1/2"	10	<b>13.42</b>	<b>7033173</b>	
	18*3/4"	10	<b>9.13</b>	<b>7033174</b>	
	22*3/4"	10	<b>11.41</b>	<b>7033175</b>	
22*1"	10	<b>15.09</b>	<b>7033176</b>		
28*1"	10	<b>17.42</b>	<b>7033177</b>		
	<b>4341G</b>	<i>Lod. savienojums ar piesl. AV</i>			
	12*1/2"	10	<b>4.48</b>	<b>7033178</b>	
	15*1/2"	10	<b>7.74</b>	<b>7033179</b>	
	15*3/4"	10	<b>11.52</b>	<b>7033180</b>	
	18*1/2"	10	<b>7.99</b>	<b>7033181</b>	
	18*3/4"	10	<b>6.60</b>	<b>7033182</b>	
	22*3/4"	10	<b>10.05</b>	<b>7033183</b>	
22*1"	10	<b>11.21</b>	<b>7033184</b>		
28*1"	10	<b>17.65</b>	<b>7033185</b>		
	<i>Kapara caurule cietā 5m</i>				
	99B12	1 mm	<b>8.47</b>	<b>7033214</b>	
	99B15	1 mm	<b>13.72</b>	<b>7033215</b>	
	99B18	1 mm	<b>16.79</b>	<b>7033216</b>	
	99B22	1 mm	<b>21.56</b>	<b>7033217</b>	
	99B28	1 mm	<b>28.84</b>	<b>7033218</b>	
	99B35	1 mm	<b>37.01</b>	<b>7033219</b>	
	<i>Kapara caurule mīkstā rullī 25m</i>				
	99A10	50	<b>6.04</b>	<b>7033211</b>	
	99A12	50	<b>7.23</b>	<b>7033212</b>	
99A15	25	<b>8.43</b>	<b>7033213</b>		
	<i>Birstīte kapara cauruļu tīrīšanai</i>				
	15mm	1026	12	<b>4.15</b>	<b>1735002</b>
	18mm	1027	12	<b>3.84</b>	<b>1735003</b>
	22mm	1028	12	<b>4.02</b>	<b>1735004</b>
	28mm	1029	12	<b>5.85</b>	<b>1735005</b>
	<i>Svammīte cauruļu tīrīšanai</i>				
		10	<b>5.02</b>	<b>1735001</b>	
	<i>PE cauruļu gala frēze</i>				
	20-63 mm		<b>19.06</b>	<b>2535030</b>	
	<i>Montāžas plāksne</i>				
	1/2"*15mm	20	<b>8.57</b>	<b>0925339</b>	











**VEIKALS**

GAB. **EUR**

**VEIKALS**

GAB. **EUR** ITĀLIJA

	<b>7250</b>	<i>Kompresijas savienojums ar ārējo vītņi</i>		
	1/2"x16	10	<b>2.35</b>	<b>0919067</b>
	1/2"x20	10	<b>3.38</b>	<b>0919068</b>
	3/4"x16	10	<b>3.21</b>	<b>0919069</b>
	3/4"x20	10	<b>3.72</b>	<b>0919070</b>
	3/4"x26	5	<b>6.57</b>	<b>0919071</b>
	1"x26	5	<b>7.45</b>	<b>0919072</b>
	1"x32	5	<b>11.74</b>	<b>0919073</b>
	<b>7251</b>	<i>Kompresijas savienojums ar iekšējo vītņi</i>		
	1/2"x16	10	<b>2.60</b>	<b>0919074</b>
	1/2"x20	10	<b>3.74</b>	<b>0919075</b>
	3/4"x16	10	<b>3.76</b>	<b>0919076</b>
	3/4"x20	10	<b>4.00</b>	<b>0919077</b>
	3/4"x26	5	<b>6.81</b>	<b>0919078</b>
	1"x26	5	<b>7.45</b>	<b>0919079</b>
	1"x32	5	<b>11.45</b>	<b>0919080</b>
	<b>7252</b>	<i>Kompresijas uzdeva</i>		
	16x16	10	<b>4.17</b>	<b>0919081</b>
	20x20	10	<b>6.47</b>	<b>0919082</b>
	26x26	10	<b>11.12</b>	<b>0919083</b>
	<b>7256</b>	<i>Kompresijas trejgabals</i>		
	16x16x16	10	<b>6.51</b>	<b>0919085</b>
	20x20x20	5	<b>9.61</b>	<b>0919086</b>
	20x16x20	5	<b>11.71</b>	<b>0919087</b>
	20x16x16	5	<b>4.98</b>	<b>0919088</b>
	20x20x16	5	<b>5.53</b>	<b>0919089</b>
	26x26x26	5	<b>16.34</b>	<b>0919090</b>
	26x20x26	5	<b>8.40</b>	<b>0919091</b>
26x26x20	5	<b>8.22</b>	<b>0919092</b>	
	<b>7257</b>	<i>Kompresijas trejgabals ar iekšējo vītņi</i>		
	16x1/2"x16	10	<b>5.31</b>	<b>0919094</b>
	20x1/2"x20	5	<b>7.74</b>	<b>0919095</b>
	20x3/4"x20	5	<b>7.98</b>	<b>0919096</b>
	26x3/4"x26	5	<b>13.60</b>	<b>0919097</b>
	26x1"x26	5	<b>17.71</b>	<b>0919098</b>
	<b>7258</b>	<i>Kompresijas trejgabals ar ārējo vītņi</i>		
	16x1/2"x16	10	<b>7.16</b>	<b>0919100</b>
	20x1/2"x20	10	<b>7.71</b>	<b>0919101</b>
	20x3/4"x20	5	<b>11.11</b>	<b>0919102</b>
	26x3/4"x26	5	<b>17.46</b>	<b>0919103</b>
	<b>7253</b>	<i>Kompresijas līkums</i>		
	16x16	10	<b>4.79</b>	<b>0919105</b>
	20x20	10	<b>6.45</b>	<b>0919106</b>
	26x26	5	<b>11.14</b>	<b>0919107</b>
	<b>7254</b>	<i>Kompresijas līkums ar iekšējo vītņi</i>		
	1/2"x16	10	<b>3.51</b>	<b>0919109</b>
	1/2"x20	10	<b>4.53</b>	<b>0919110</b>
	3/4"x16	10	<b>4.67</b>	<b>0919111</b>
	3/4"x20	10	<b>5.09</b>	<b>0919112</b>
	3/4"x26	5	<b>9.17</b>	<b>0919113</b>
	1"x26	5	<b>10.19</b>	<b>0919114</b>
1"x32	5	<b>11.92</b>	<b>0919115</b>	







	<b>7255</b>	<i>Kompresijas līkums ar ārējo vītņi</i>		
	1/2"x16	10	<b>3.42</b>	<b>0919116</b>
	1/2"x20	10	<b>4.84</b>	<b>0919117</b>
	3/4"x16	10	<b>4.53</b>	<b>0919118</b>
	3/4"x20	10	<b>4.67</b>	<b>0919119</b>
	3/4"x26	5	<b>8.28</b>	<b>0919120</b>
	1"x26	5	<b>10.63</b>	<b>0919121</b>
	1"x32	5	<b>11.92</b>	<b>0919122</b>
	<b>7259</b>	<i>Kompresijas līkums ar sienas stiprinājumu</i>		
	1/2"x16	10	<b>3.96</b>	<b>0919123</b>
	1/2"x20	10	<b>5.04</b>	<b>0919124</b>
	3/4"x16	5	<b>5.83</b>	<b>0919125</b>
	3/4"x20	5	<b>6.43</b>	<b>0919126</b>
	<b>7260</b>	<i>Kompresijas pāreja ar saskrūvi</i>		
	1/2"x16	20	<b>6.53</b>	<b>0919127</b>
	<b>7010N</b>	<i>Eirokonusa pieslēgs</i>		
	16x2.0x1/2"	10	<b>3.20</b>	<b>0919128</b>
	20x2.0x3/4"	10	<b>3.91</b>	<b>0919129</b>
	<b>3813 M</b>	<i>Kalibrators</i>		
	D16	1	<b>11.39</b>	<b>6435003</b>
	D20	1	<b>6.94</b>	<b>6435001</b>
	D26	1	<b>6.94</b>	<b>6435002</b>
	D12-16	1	<b>11.45</b>	<b>6435005</b>
	<b>3813 M</b>	<i>Kalibrators D12-D26</i>		
		1	<b>9.52</b>	<b>6435004</b>
	<b>3813</b>	<i>Kalibrators</i>		
			<b>3.53</b>	<b>0935001</b>
	<b>7271</b>	<i>PEX-AL-PEX caurule Itālija</i>		
	16x2,0	100 m	<b>1.47</b>	<b>0919130</b>
	20x2,0	100 m	<b>2.19</b>	<b>0919131</b>
	26x3.0	50 m	<b>4.14</b>	<b>0919132</b>
	<b>7271F</b>	<i>PEX-AL-PEX caurule Ķīna</i>		
	26x3.0	50 m	<b>1.63</b>	<b>9519037</b>
	<b>8595/96</b>	<i>Liekšanas spirāle, ārējā</i>		
	16mm		<b>5.14</b>	<b>2135001</b>
	20mm		<b>8.61</b>	<b>2135002</b>











VEIKALS

VEIKALS











GAB. EUR









GAB. EUR ITĀLIJA

	<b>7230</b>	<i>Presējams savienojums ar ārējo vītņi</i>			
		1/2"x16	10	<b>2.45</b>	<b>0919001</b>
		1/2"x20	10	<b>2.95</b>	<b>0919002</b>
		3/4"x16	10	<b>3.06</b>	<b>0919003</b>
		3/4"x20	10	<b>3.48</b>	<b>0919004</b>
		3/4"x26	5	<b>4.63</b>	<b>0919005</b>
		1"x26	5	<b>6.38</b>	<b>0919006</b>
		1"x32	5	<b>8.15</b>	<b>0919007</b>
	<b>7231</b>	<i>Presējams savienojums ar iekšējo vītņi</i>			
		1/2"x16	10	<b>2.44</b>	<b>0919008</b>
		1/2"x20	10	<b>2.85</b>	<b>0919009</b>
		3/4"x16	10	<b>3.99</b>	<b>0919010</b>
		3/4"x20	10	<b>3.49</b>	<b>0919011</b>
		3/4"x26	5	<b>5.43</b>	<b>0919012</b>
		1"x26	5	<b>6.79</b>	<b>0919013</b>
		1"x32	5	<b>8.42</b>	<b>0919014</b>
	<b>7232</b>	<i>Presējama uzmava</i>			
		16x16	10	<b>2.92</b>	<b>0919015</b>
		20x20	10	<b>3.66</b>	<b>0919016</b>
		26x26	5	<b>7.20</b>	<b>0919017</b>
		32x32	5	<b>10.87</b>	<b>0919018</b>
		20x16	10	<b>3.81</b>	<b>0919019</b>
	<b>7236</b>	<i>Presējams trejgabals</i>			
		16x16x16	10	<b>4.64</b>	<b>0919022</b>
		20x20x20	5	<b>6.75</b>	<b>0919023</b>
		26x26x26	2	<b>12.23</b>	<b>0919024</b>
		32x32x32	2	<b>19.70</b>	<b>0919025</b>
		20x16x16	5	<b>7.47</b>	<b>0919026</b>
		20x16x20	5	<b>7.47</b>	<b>0919027</b>
		20x20x16	5	<b>7.47</b>	<b>0919028</b>
		20x26x20	5	<b>12.23</b>	<b>0919029</b>
		26x16x26	5	<b>12.23</b>	<b>0919030</b>
		26x20x20	5	<b>12.23</b>	<b>0919031</b>
		26x20x26	5	<b>12.23</b>	<b>0919032</b>
		26x26x20	5	<b>12.23</b>	<b>0919033</b>
		32x20x32	2	<b>20.38</b>	<b>0919034</b>
	32x26x32	2	<b>20.65</b>	<b>0919035</b>	
	<b>7237</b>	<i>Presējams trejgabals ar iekšējo vītņi</i>			
		16x1/2"x16	5	<b>4.85</b>	<b>0919036</b>
		20x1/2"x20	5	<b>6.41</b>	<b>0919037</b>
		20x3/4"x20	5	<b>6.97</b>	<b>0919038</b>
		26x3/4"x26	5	<b>10.87</b>	<b>0919039</b>
		26x1"x26	5	<b>11.56</b>	<b>0919040</b>
		32x1"x32	2	<b>16.30</b>	<b>0919041</b>
	<b>7238</b>	<i>Presējams trejgabals ar ārējo vītņi</i>			
		16x1/2"x16	5	<b>4.95</b>	<b>0919042</b>
		20x1/2"x20	5	<b>7.20</b>	<b>0919043</b>
		26x3/4"x26	5	<b>10.87</b>	<b>0919044</b>
		26x1"x26	5	<b>12.39</b>	<b>0919045</b>
	<b>7233</b>	<i>Presējams līkums</i>			
		16x16	10	<b>3.25</b>	<b>0919047</b>
		20x20	5	<b>4.57</b>	<b>0919048</b>
		26x26	5	<b>8.56</b>	<b>0919049</b>
	32x32	5	<b>11.55</b>	<b>0919050</b>	

	<b>7234</b>	<i>Presējams līkums ar iekšējo vītņi</i>			
		1/2"x16	10	<b>3.30</b>	<b>0919051</b>
		1/2"x20	10	<b>4.04</b>	<b>0919052</b>
		3/4"x20	10	<b>5.48</b>	<b>0919053</b>
		3/4"x26	5	<b>7.60</b>	<b>0919054</b>
		1"x26	5	<b>8.68</b>	<b>0919055</b>
		1"x32	2	<b>10.05</b>	<b>0919056</b>
	<b>7235</b>	<i>Presējams līkums ar ārējo vītņi</i>			
		1/2"x16	10	<b>3.27</b>	<b>0919057</b>
		1/2"x20	10	<b>4.08</b>	<b>0919058</b>
		3/4"x20	10	<b>5.48</b>	<b>0919059</b>
		3/4"x26	5	<b>7.60</b>	<b>0919060</b>
		1"x26	5	<b>8.68</b>	<b>0919061</b>
	<b>7239</b>	<i>Presējams līkums ar sienas stiprinājumu</i>			
		1/2"x16	5	<b>4.18</b>	<b>0919063</b>
	1/2"x20	5	<b>5.43</b>	<b>0919064</b>	
	<b>7246</b>	<i>Presējama pāreja, saskrūve</i>			
		1/2"x16	10	<b>3.78</b>	<b>0919065</b>
	1/2"x20	10	<b>5.01</b>	<b>0919066</b>	
	<b>3813 M</b>	<i>Kalibrators</i>			
		D16	1	<b>11.39</b>	<b>6435003</b>
		D20	1	<b>6.94</b>	<b>6435001</b>
		D26	1	<b>6.94</b>	<b>6435002</b>
	D12-16	1	<b>11.45</b>	<b>6435005</b>	
	<b>3813M</b>	<i>Kalibrators D12-D26</i>			
			1	<b>9.52</b>	<b>6435004</b>
	<b>3813</b>	<i>Kalibrators</i>			
				<b>3.53</b>	<b>0935001</b>
	<b>7271</b>	<i>PEX-AL-PEX caurule Itālija</i>			
		16x2,0	100 m	<b>1.47</b>	<b>0919130</b>
		20x2,0	100 m	<b>2.19</b>	<b>0919131</b>
		26x3,0	50 m	<b>4.14</b>	<b>0919132</b>
	<b>7271F</b>	<i>PEX-AL-PEX caurule Ķīna</i>			
		26x3,0	50 m	<b>1.63</b>	<b>9519037</b>
	<b>8595/96</b>	<i>Liekšanas spirāle, ārējā</i>			
		16mm		<b>5.14</b>	<b>2135001</b>
		20mm		<b>8.61</b>	<b>2135002</b>











			GAB.	EUR		
	3901F	<i>Kompresijas savienojums ar ārējo vītņi</i>				
	3/4"x16	46	<del>1.62</del>	0.98	9519017	
	1"x26	73	<del>2.76</del>	1.67	6419034	
	3902F	<i>Kompresijas savienojums ar iekšējo vītņi</i>				
	1"x26	38	<del>2.85</del>	1.73	6419036	
	3903F	<i>Kompresijas uzstāve</i>				
	16x20	274	<del>2.52</del>	1.53	9519020	
	26x26	41	<del>3.94</del>	2.39	6419037	
	3931F	<i>Kompresijas trejgabals</i>				
	20x16x20	685	<del>3.35</del>	2.03	9519010	
	16x20x16	868	<del>3.53</del>	2.14	9519022	
	20x16x16	920	<del>3.53</del>	2.14	9519023	
	20x20x16	926	<del>4.03</del>	2.44	9519024	
	26x20x26	40	<del>8.28</del>	5.02	6419039	
	26x26x26	34	<del>5.53</del>	3.35	6419038	
	3932F	<i>Kompresijas trejgabals ar iekšējo vītņi</i>				
	16x3/4"x16	916	<del>3.35</del>	2.03	9519031	
	20x3/4"x20	430	<del>4.34</del>	2.63	9519032	
	26x3/4"x26	32	<del>4.93</del>	2.99	6419043	
	26x1"x26	40	<del>5.33</del>	3.23	6419044	
	3933F	<i>Kompresijas trejgabals ar ārējo vītņi</i>				
	16x3/4"x16	921	<del>2.85</del>	1.73	9519015	
	20x3/4"x20	589	<del>4.34</del>	2.63	9519016	
	26x3/4"x26	35	<del>4.36</del>	2.64	6419045	
	26x1"x26	40	<del>5.33</del>	3.23	6419046	
	3952F	<i>Kompresijas līkums ar iekšējo vītņi</i>				
	3/4"x16	705	<del>2.16</del>	1.31	9519028	
	3/4"x26	63	<del>3.09</del>	1.87	6419040	
	1"x26	60	<del>3.65</del>	2.21	6419041	
	3953F	<i>Kompresijas līkums ar ārējo vītņi</i>				
	3/4"x16	713	<del>1.98</del>	1.20	9519012	
	3/4"x20	336	<del>2.48</del>	1.50	9519014	
	3/4"x26	50	<del>2.85</del>	1.73	6419047	
	1"x26	49	<del>3.25</del>	1.97	6419048	
	3954F	<i>Kompresijas līkums ar sienas stiprinājumu</i>				
	1/2"x20	98	<del>2.51</del>	1.52	6419030	
	3/4"x16	45	<del>2.46</del>	1.49	6419029	
	4002 F	<i>Presējams savienojums ar iekšējo vītņi</i>				
1/2"x16	64	<del>1.55</del>	0.94	6419003		







			GAB.	EUR		
	4033 F	<i>Presējams trejgabals ar ārējo vītņi</i>				
	16x1/2"x16	41	<del>2.52</del>	1.53	6419024	
	3813 M	<i>Kalibrators</i>				
	D16	1	<del>11.39</del>		6435003	
	D20	1	<del>6.94</del>		6435001	
	D26	1	<del>6.94</del>		6435002	
	D12-16	1	<del>11.45</del>		6435005	
	3813	<i>Kalibrators</i>				
		1	<del>3.53</del>		0935001	
	921 PPR	<i>Skēres caurulēm 0-42mm nerūsējoša tērauda asmenis</i>				
			<del>14.73</del>		3435001	
			<del>14.46</del>		3435002	
	100902	<i>Prese D16-32, mehāniskā</i>				
					U-gali 16-32	
					TH-gali 16-32	
		16-32	1	<del>200.33</del>	8235010	
	3811 F	<i>Prese D16-20, mehāniskā</i>				
		16-20	1	<del>148.00</del>	7635013	
	7271F	<i>PEX-AL-PEX caurule Ķīna</i>				
	26x3.0	50 m	<del>1.63</del>		9519037	
	7271	<i>PEX-AL-PEX caurule Itālija</i>				
	16x2.0	100 m	<del>1.47</del>		0919130	
	20x2.0	100 m	<del>2.19</del>		0919131	
	26x3.0	50 m	<del>4.14</del>		0919132	
	8595/96	<i>Liekšanas spirāle, ārējā</i>				
	16mm		<del>5.14</del>		2135001	
	20mm		<del>8.61</del>		2135002	

















## Čuguna veidgabali

GAB. EUR VEIKALS















GAB. EUR VEIKALS

	<b>85 M</b>	<i>Apeja</i>		
	1/2"	10	<b>2.79</b>	<b>2124001</b>
	3/4"	10	<b>4.14</b>	<b>2124002</b>
	1"	10	<b>12.58</b>	<b>2124003</b>
	<b>90 M</b>	<i>Līkums (I-I)</i>		
	1/2"	10	<b>0.78</b>	<b>2124004</b>
	3/4"	10	<b>1.07</b>	<b>2124005</b>
	1"	10	<b>1.59</b>	<b>2124006</b>
	1,1/4"		<b>3.09</b>	<b>2124007</b>
	1,1/2"	22	<b>5.04</b>	<b>2124008</b>
	2"		<b>5.88</b>	<b>2124009</b>
	<b>90 M</b>	<i>Līkums ar pāreju</i>		
	3/4"x1/2"	10	<b>1.54</b>	<b>2124010</b>
	1"x1/2"	10	<b>2.11</b>	<b>2124011</b>
	1"x3/4"	10	<b>2.27</b>	<b>2124012</b>
	1,1/4"x1/2"		<b>4.28</b>	<b>2124013</b>
	1,1/4"x3/4"		<b>5.84</b>	<b>2124014</b>
	1,1/4"x1"		<b>4.65</b>	<b>2124015</b>
	1,1/2"x1"		<b>7.38</b>	<b>2124016</b>
1,1/2"x1,1/4"		<b>6.75</b>	<b>2124017</b>	
2"x1,1/4"		<b>13.75</b>	<b>2124018</b>	
2"x1,1/2"		<b>9.75</b>	<b>2124019</b>	
	<b>120 M</b>	<i>Līkums 45° (I-I)</i>		
	1/2"	10	<b>2.94</b>	<b>2124020</b>
	3/4"	10	<b>4.02</b>	<b>2124021</b>
	1"	10	<b>4.55</b>	<b>2124022</b>
	<b>92 M</b>	<i>Līkums (I-Ā)</i>		
	1/2"	10	<b>0.83</b>	<b>2124023</b>
	3/4"	10	<b>1.23</b>	<b>2124024</b>
	1"	10	<b>2.07</b>	<b>2124025</b>
	1,1/4"		<b>3.64</b>	<b>2124026</b>
	1,1/2"	22	<b>5.52</b>	<b>2124027</b>
	2"	12	<b>7.15</b>	<b>2124028</b>
	<b>121 M</b>	<i>Līkums 45° (I-A)</i>		
	1/2"	10	<b>2.89</b>	<b>2124029</b>
	3/4"	10	<b>3.74</b>	<b>2124030</b>
	1"	10	<b>5.68</b>	<b>2124031</b>
	<b>130 M</b>	<i>Trejšgabals</i>		
	1/2"	10	<b>1.10</b>	<b>2124032</b>
	3/4"	10	<b>1.59</b>	<b>2124033</b>
	1"	10	<b>2.44</b>	<b>2124034</b>
	1,1/4"		<b>4.21</b>	<b>2124035</b>
	1,1/2"		<b>6.53</b>	<b>2124036</b>
	2"	10	<b>9.31</b>	<b>2124037</b>
	<b>130 M</b>	<i>Trejšgabals - pāreja</i>		
	1/2"x3/4"	10	<b>2.07</b>	<b>2124038</b>
	3/4"x1/2"	10	<b>1.63</b>	<b>2124039</b>
	1"x1/2"	10	<b>2.21</b>	<b>2124040</b>
	1"x3/4"	10	<b>2.41</b>	<b>2124041</b>
	1,1/4"x1/2"		<b>3.78</b>	<b>2124042</b>
	1,1/4"x3/4"		<b>4.02</b>	<b>2124043</b>
	1,1/4"x1"		<b>4.42</b>	<b>2124044</b>
1,1/2"x1/2"		<b>5.04</b>	<b>2124045</b>	
1,1/2"x3/4"		<b>5.33</b>	<b>2124046</b>	
1,1/2"x1"		<b>6.00</b>	<b>2124047</b>	







	<b>130 M</b>	<i>Trejšgabals - pāreja</i>		
	1,1/2"x1,1/4"		<b>7.93</b>	<b>2124048</b>
	2"x1/2"		<b>8.44</b>	<b>2124049</b>
	2"x3/4"		<b>9.89</b>	<b>2124050</b>
	2"x1"		<b>7.50</b>	<b>2124051</b>
	2"x1,1/4"		<b>9.63</b>	<b>2124052</b>
	2"x1,1/2"		<b>11.53</b>	<b>2124053</b>
	<b>290 M</b>	<i>Korkis (AV)</i>		
	1/2"	10	<b>0.65</b>	<b>2124054</b>
	3/4"	10	<b>0.76</b>	<b>2124055</b>
	1"	10	<b>0.84</b>	<b>2124056</b>
	1,1/4"	10	<b>1.54</b>	<b>2124057</b>
	1,1/2"	10	<b>1.87</b>	<b>2124058</b>
	2"		<b>3.42</b>	<b>2124059</b>
	<b>300 M</b>	<i>Korkis (IV)</i>		
	1/2"	10	<b>0.92</b>	<b>2124060</b>
	3/4"	10	<b>1.07</b>	<b>2124061</b>
	1"	10	<b>1.24</b>	<b>2124062</b>
	1,1/4"	10	<b>1.94</b>	<b>2124063</b>
	1,1/2"	10	<b>2.42</b>	<b>2124064</b>
	2"		<b>4.56</b>	<b>2124065</b>
	<b>270 M</b>	<i>Uzmava</i>		
	1/2"	10	<b>0.79</b>	<b>2124066</b>
	3/4"	10	<b>1.06</b>	<b>2124067</b>
	1"	10	<b>1.38</b>	<b>2124068</b>
	1,1/4"		<b>2.25</b>	<b>2124069</b>
	1,1/2"		<b>3.08</b>	<b>2124070</b>
	2"		<b>4.72</b>	<b>2124071</b>
	<b>240 M</b>	<i>Uzmava - pāreja</i>		
	3/4"x1/2"	10	<b>1.32</b>	<b>2124072</b>
	1"x1/2"	10	<b>1.74</b>	<b>2124073</b>
	1"x3/4"	10	<b>1.56</b>	<b>2124074</b>
	1,1/4"x1/2"	10	<b>3.34</b>	<b>2124075</b>
	1,1/4"x3/4"	10	<b>3.03</b>	<b>2124076</b>
	1,1/4"x1"	10	<b>2.82</b>	<b>2124077</b>
	1,1/2"x1/2"		<b>7.32</b>	<b>2124078</b>
	1,1/2"x3/4"		<b>6.45</b>	<b>2124079</b>
	1,1/2"x1"		<b>3.57</b>	<b>2124080</b>
	1,1/2"x1,1/4"		<b>3.94</b>	<b>2124081</b>
2"x1/2"		<b>10.05</b>	<b>2124082</b>	
2"x3/4"		<b>7.55</b>	<b>2124083</b>	
2"x1"		<b>6.92</b>	<b>2124084</b>	
2"x1,1/4"		<b>6.20</b>	<b>2124085</b>	
2"x1,1/2"		<b>5.86</b>	<b>2124086</b>	
	<b>280 M</b>	<i>Nipelis</i>		
	1/2"	10	<b>0.72</b>	<b>2124087</b>
	3/4"	10	<b>1.00</b>	<b>2124088</b>
	1"	10	<b>1.33</b>	<b>2124089</b>
	1,1/4"	10	<b>2.28</b>	<b>2124090</b>
	1,1/2"	10	<b>2.68</b>	<b>2124091</b>
	2"		<b>4.86</b>	<b>2124092</b>
	<b>245 M</b>	<i>Nipelis reducēts</i>		
	3/4"x1/2"	10	<b>1.40</b>	<b>2124093</b>
	1"x1/2"	10	<b>2.96</b>	<b>2124094</b>
	1"x3/4"	10	<b>1.57</b>	<b>2124095</b>
	1,1/4"x1/2"	10	<b>6.22</b>	<b>2124096</b>
	1,1/4"x3/4"	10	<b>5.36</b>	<b>2124097</b>
	1,1/4"x1"	10	<b>2.68</b>	<b>2124098</b>
	1,1/2"x3/4"		<b>5.36</b>	<b>2124099</b>









		GAB.	EUR	VEIKALS			GAB.	EUR	VEIKALS
	<b>245 M</b>	<i>Nipelis reducēts</i>							
	1,1/2"x1"		<b>8.53</b>	<b>2124100</b>					
	1,1/2"x1,1/4"		<b>3.68</b>	<b>2124101</b>					
	2"x1"		<b>7.69</b>	<b>2124102</b>					
	2"x1,1/4"		<b>6.96</b>	<b>2124103</b>					
	2"x1,1/2"		<b>6.39</b>	<b>2124104</b>					
	<b>241 M</b>	<i>Vītņu pāreja (Ā-I)</i>							
	1/2"x3/8"		<b>0.26</b>	<b>2124105</b>					
	3/4"x1/2"	10	<b>0.73</b>	<b>2124106</b>					
	1"x1/2"	10	<b>1.05</b>	<b>2124107</b>					
	1"x3/4"	10	<b>0.94</b>	<b>2124108</b>					
	1,1/4"x1/2"	10	<b>1.84</b>	<b>2124109</b>					
	1,1/4"x3/4"	10	<b>1.59</b>	<b>2124110</b>					
	1,1/4"x1"	10	<b>1.14</b>	<b>2124111</b>					
	1,1/2"x1/2"	10	<b>2.34</b>	<b>2124112</b>					
	1,1/2"x3/4"	10	<b>2.55</b>	<b>2124113</b>					
	1,1/2"x1"	10	<b>1.71</b>	<b>2124114</b>					
	1,1/2"x1,1/4"	10	<b>1.79</b>	<b>2124115</b>					
	2"x1/2"	10	<b>4.72</b>	<b>2124116</b>					
	2"x3/4"		<b>4.67</b>	<b>2124117</b>					
2"x1"		<b>3.86</b>	<b>2124118</b>						
2"x1,1/4"		<b>3.63</b>	<b>2124119</b>						
2"x1,1/2"		<b>3.29</b>	<b>2124120</b>						
	<b>529 M</b>	<i>Pagarinātājs</i>							
	1/2"	10	<b>1.43</b>	<b>2124121</b>					
	3/4"	10	<b>2.14</b>	<b>2124122</b>					
1"	10	<b>4.16</b>	<b>2124123</b>						
	<b>246 M</b>	<i>Vītņu pāreja</i>							
	3/4"x1/2"	10	<b>1.73</b>	<b>2124124</b>					
	1"x1/2"	10	<b>2.88</b>	<b>2124125</b>					
	1"x3/4"	10	<b>2.96</b>	<b>2124126</b>					
	1,1/4"x1/2"	10	<b>7.83</b>	<b>2124127</b>					
	1,1/4"x3/4"	10	<b>5.54</b>	<b>2124128</b>					
	1,1/4"x1"	10	<b>3.98</b>	<b>2124129</b>					
	1,1/2"x3/4"		<b>6.69</b>	<b>2124130</b>					
	1,1/2"x1"		<b>7.55</b>	<b>2124131</b>					
	1,1/2"x1,1/4"		<b>6.68</b>	<b>2124132</b>					
	2"x1"		<b>11.78</b>	<b>2124133</b>					
	2"x1,1/4"		<b>9.00</b>	<b>2124134</b>					
2"x1,1/2"		<b>9.45</b>	<b>2124135</b>						
	<b>330 M</b>	<i>Izjaucams savienojums (I-I)</i>							
	1/2"	10	<b>2.78</b>	<b>2124136</b>					
	3/4"	10	<b>3.26</b>	<b>2124137</b>					
	1"	10	<b>3.68</b>	<b>2124138</b>					
	1,1/4"		<b>6.28</b>	<b>2124139</b>					
1,1/2"		<b>8.06</b>	<b>2124140</b>						
2"		<b>13.27</b>	<b>2124141</b>						
	<b>331 M</b>	<i>Izjaucams savienojums (I-A)</i>							
	1/2"	10	<b>3.53</b>	<b>2124142</b>					
	3/4"	10	<b>3.91</b>	<b>2124143</b>					
	1"	10	<b>4.73</b>	<b>2124144</b>					
	1,1/4"		<b>8.35</b>	<b>2124145</b>					
	1,1/2"		<b>10.07</b>	<b>2124146</b>					
2"		<b>15.82</b>	<b>2124147</b>						
	<b>03576</b>	<i>Gumijas blīve izjaucamiem savienojumiem</i>							
	1/2"	100	<b>0.32</b>	<b>2166001</b>					
	3/4"	100	<b>0.28</b>	<b>2166002</b>					
	1"	100	<b>0.46</b>	<b>2166003</b>					
	1,1/2"	100	<b>0.66</b>	<b>2166004</b>					
	1,1/4"	100	<b>0.74</b>	<b>2166005</b>					
2"	100	<b>0.68</b>	<b>2166006</b>						
	<b>340 M</b>	<i>Izjaucams savienojums (konuss (I-I))</i>							
	1/2"	10	<b>3.54</b>	<b>2124148</b>					
	3/4"	10	<b>4.03</b>	<b>2124149</b>					
	1"	10	<b>4.61</b>	<b>2124150</b>					
	1,1/4"		<b>7.60</b>	<b>2124151</b>					
	1,1/2"		<b>8.93</b>	<b>2124152</b>					
2"		<b>14.65</b>	<b>2124153</b>						
	<b>341 M</b>	<i>Izjaucams savienojums (konuss (I-A))</i>							
	1/2"	10	<b>3.45</b>	<b>2124154</b>					
	3/4"	10	<b>4.19</b>	<b>2124155</b>					
	1"	10	<b>5.15</b>	<b>2124156</b>					
	1,1/4"		<b>8.19</b>	<b>2124157</b>					
	1,1/2"		<b>10.39</b>	<b>2124158</b>					
2"		<b>16.62</b>	<b>2124159</b>						
	<b>95 M</b>	<i>Izjaucams savienojums (I-I)</i>							
	1/2"		<b>4.96</b>	<b>2124160</b>					
	3/4"		<b>5.97</b>	<b>2124161</b>					
	1"		<b>7.39</b>	<b>2124162</b>					
	1,1/4"		<b>15.62</b>	<b>2124163</b>					
	1,1/2"		<b>21.77</b>	<b>2124164</b>					
2"		<b>32.51</b>	<b>2124165</b>						
	<b>96 M</b>	<i>Izjaucams savienojums (I-A)</i>							
	1/2"		<b>5.55</b>	<b>2124166</b>					
	3/4"		<b>6.67</b>	<b>2124167</b>					
	1"		<b>8.48</b>	<b>2124168</b>					
	1,1/4"		<b>17.48</b>	<b>2124169</b>					
	1,1/2"		<b>23.73</b>	<b>2124170</b>					
2"		<b>34.43</b>	<b>2124171</b>						
	<b>93 M</b>	<i>Savienojuma komplekts sūkņim</i>							
	1"		<b>6.37</b>	<b>2124172</b>					
	1,1/4"		<b>8.13</b>	<b>2124173</b>					
	<b>180 M</b>	<i>Krusts</i>							
	1/2"	10	<b>4.41</b>	<b>2124174</b>					
	3/4"	10	<b>6.68</b>	<b>2124175</b>					
	1"		<b>8.14</b>	<b>2124176</b>					
	1,1/4"		<b>10.43</b>	<b>2124177</b>					
	1,1/2"		<b>15.06</b>	<b>2124178</b>					
2"		<b>22.86</b>	<b>2124179</b>						
	<b>310 M</b>	<i>Kontruzgrieznis</i>							
	1/2"		<b>0.84</b>	<b>2124180</b>					
	3/4"		<b>0.85</b>	<b>2124181</b>					
	1"		<b>1.13</b>	<b>2124182</b>					
	1,1/4"		<b>1.66</b>	<b>2124183</b>					
	1,1/2"		<b>1.94</b>	<b>2124184</b>					
2"		<b>3.47</b>	<b>2124185</b>						
	<b>291 M</b>	<i>Korķis radiatoram kreisā vītne</i>							
	1,1/4"x1/2"		<b>1.50</b>	<b>2124407</b>					
	1,1/4"x3/4"		<b>1.50</b>	<b>2124408</b>					
	<i>Korķis radiatoram labā vītne</i>								
1,1/4"x1/2"		<b>1.50</b>	<b>2124410</b>						
1,1/4"x3/4"		<b>1.50</b>	<b>2124411</b>						
	<b>291 M</b>	<i>Korķis radiatoram labā vītne</i>							
	1,1/4"		<b>1.50</b>	<b>2124409</b>					
<i>Korķis radiatoram kreisā vītne</i>									
1,1/4"		<b>1.50</b>	<b>2124406</b>						

## Cinkoti čuguna veidgabali

		GAB.	EUR	VEIKALS		
	<b>85 C</b>			<i>Apeja</i>		
	1/2"	10	<b>3.37</b>	2124186		
	3/4"	10	<b>5.24</b>	2124187		
	1"	10	<b>13.83</b>	2124188		
	<b>90 C</b>			<i>Līkums (I-I)</i>		
	1/2"	10	<b>1.02</b>	2124189		
	3/4"	10	<b>1.46</b>	2124190		
	1"	10	<b>2.14</b>	2124191		
	1,1/4"		<b>3.89</b>	2124192		
	1,1/2"	22	<b>6.30</b>	2124193		
	<b>90 C</b>			<i>Līkums ar pāreju</i>		
	3/4"x1/2"	10	<b>1.92</b>	2124195		
	1"x1/2"	10	<b>2.71</b>	2124196		
	1"x3/4"	10	<b>2.88</b>	2124197		
	1,1/4"x1/2"		<b>5.33</b>	2124198		
	1,1/4"x3/4"		<b>7.00</b>	2124199		
	1,1/4"x1"		<b>5.58</b>	2124200		
	1,1/2"x1"		<b>8.45</b>	2124201		
	1,1/2"x1,1/4"		<b>8.92</b>	2124202		
	2"x1,1/4"		<b>17.68</b>	2124203		
	<b>120 C</b>			<i>Līkums 45° (I-I)</i>		
	1/2"	10	<b>3.37</b>	2124205		
	3/4"	10	<b>4.25</b>	2124206		
	1"	10	<b>5.08</b>	2124207		
	<b>92 C</b>			<i>Līkums (I-Ā)</i>		
	1/2"	10	<b>1.10</b>	2124208		
	3/4"	10	<b>1.76</b>	2124209		
	1"	10	<b>2.71</b>	2124210		
	1,1/4"		<b>4.64</b>	2124211		
	1,1/2"	22	<b>6.87</b>	2124212		
	<b>121 C</b>			<i>Līkums 45° (I-A)</i>		
	1/2"	10	<b>3.42</b>	2124214		
	3/4"	10	<b>4.74</b>	2124215		
	1"	10	<b>6.90</b>	2124216		
	<b>130 C</b>			<i>Trejšgabals</i>		
	1/2"	10	<b>1.47</b>	2124217		
	3/4"	10	<b>2.14</b>	2124218		
	1"	10	<b>3.34</b>	2124219		
	1,1/4"		<b>5.43</b>	2124220		
	1,1/2"		<b>8.28</b>	2124221		
	2"	10	<b>11.82</b>	2124222		
	<b>130 C</b>			<i>Trejšgabals - pāreja</i>		
	1/2"x3/4"	10	<b>4.94</b>	2124223		
	3/4"x1/2"	10	<b>2.17</b>	2124224		
	1"x1/2"	10	<b>2.87</b>	2124225		
	1"x3/4"	10	<b>3.16</b>	2124226		
	1,1/4"x1/2"		<b>4.81</b>	2124227		
	1,1/4"x3/4"		<b>4.99</b>	2124228		
	1,1/4"x1"		<b>5.61</b>	2124229		
	1,1/2"x1/2"		<b>6.32</b>	2124230		
	1,1/2"x3/4"		<b>6.73</b>	2124231		
1,1/2"x1"		<b>7.51</b>	2124232			
	<b>130 C</b>			<i>Trejšgabals - pāreja</i>		
	1,1/2"x1,1/4"		<b>9.90</b>	2124233		
	2"x1/2"		<b>11.30</b>	2124234		
	2"x3/4"		<b>12.00</b>	2124235		
	2"x1"		<b>9.37</b>	2124236		
	2"x1,1/4"		<b>11.98</b>	2124237		
	<b>290 C</b>			<i>Korķis (AV)</i>		
	1/2"	10	<b>0.72</b>	2124239		
	3/4"	10	<b>0.97</b>	2124240		
	1"	10	<b>1.26</b>	2124241		
	1,1/4"	10	<b>1.92</b>	2124242		
	1,1/2"	10	<b>2.31</b>	2124243		
	<b>300 C</b>			<i>Korķis (IV)</i>		
	1/2"	10	<b>1.11</b>	2124245		
	3/4"	10	<b>1.36</b>	2124246		
	1"	10	<b>1.59</b>	2124247		
	1,1/4"	10	<b>2.45</b>	2124248		
	1,1/2"	10	<b>3.10</b>	2124249		
	<b>270 C</b>			<i>Uzmava</i>		
	1/2"	10	<b>1.02</b>	2124251		
	3/4"	10	<b>1.36</b>	2124252		
	1"	10	<b>1.90</b>	2124253		
	1,1/4"		<b>2.94</b>	2124254		
	1,1/2"		<b>4.26</b>	2124255		
	<b>240 C</b>			<i>Uzmava - pāreja</i>		
	3/4"x1/2"	10	<b>1.66</b>	2124257		
	1"x1/2"	10	<b>2.19</b>	2124258		
	1"x3/4"	10	<b>2.01</b>	2124259		
	1,1/4"x1/2"	10	<b>4.12</b>	2124260		
	1,1/4"x3/4"	10	<b>3.78</b>	2124261		
	1,1/4"x1"	10	<b>3.54</b>	2124262		
	1,1/2"x1/2"		<b>9.17</b>	2124263		
	1,1/2"x3/4"		<b>8.06</b>	2124264		
	1,1/2"x1"		<b>4.50</b>	2124265		
	<b>280 C</b>			<i>Nipelis</i>		
	1/2"	10	<b>0.96</b>	2124272		
	3/4"	10	<b>1.29</b>	2124273		
	1"	10	<b>1.71</b>	2124274		
	1,1/4"	10	<b>2.88</b>	2124275		
	1,1/2"	10	<b>3.29</b>	2124276		
	2"		<b>6.14</b>	2124277		
	<b>245 C</b>			<i>Nipelis reducēts</i>		
	3/4"x1/2"	10	<b>1.79</b>	2124278		
	1"x1/2"	10	<b>3.71</b>	2124279		
	1"x3/4"	10	<b>2.01</b>	2124280		
	1,1/4"x1/2"	10	<b>7.89</b>	2124281		
	1,1/4"x3/4"	10	<b>6.71</b>	2124282		
	1,1/4"x1"	10	<b>3.29</b>	2124283		
1,1/2"x3/4"		<b>6.76</b>	2124284			

## Cinkoti čuguna veidgabali

		GAB.	EUR	VEIKALS
	<b>245 C</b>			<i>Nipelis reducēts</i>
	1,1/2"x1"		<b>8.10</b>	2124285
	1,1/2"x1,1/4"		<b>3.99</b>	2124286
	2"x1"		<b>9.72</b>	2124287
	2"x1,1/4"		<b>8.77</b>	2124288
	2"x1,1/2"		<b>8.03</b>	2124289
	<b>241 C</b>			<i>Vītņu pāreja (A-I)</i>
	1/2"x3/8"		<b>0.80</b>	2124290
	3/4"x1/2"	10	<b>0.94</b>	2124291
	1"x1/2"	10	<b>1.32</b>	2124292
	1"x3/4"	10	<b>1.24</b>	2124293
	1,1/4"x1/2"	10	<b>2.28</b>	2124294
	1,1/4"x3/4"	10	<b>1.98</b>	2124295
	1,1/4"x1"	10	<b>1.57</b>	2124296
	1,1/2"x1/2"	10	<b>2.95</b>	2124297
	1,1/2"x3/4"	10	<b>3.17</b>	2124298
	1,1/2"x1"	10	<b>2.20</b>	2124299
	1,1/2"x1,1/4"	10	<b>2.35</b>	2124300
	2"x1/2"	10	<b>5.95</b>	2124301
	2"x3/4"		<b>5.89</b>	2124302
	2"x1"		<b>4.86</b>	2124303
	2"x1,1/4"		<b>4.53</b>	2124304
	2"x1,1/2"		<b>4.22</b>	2124305
	<b>529 C</b>			<i>Pagarinātājs</i>
	1/2"	10	<b>1.87</b>	2124306
	3/4"	10	<b>2.65</b>	2124307
	1"	10	<b>4.95</b>	2124308
	<b>246 C</b>			<i>Vītņu pāreja</i>
	3/4"x1/2"	10	<b>2.20</b>	2124309
	1"x1/2"	10	<b>3.51</b>	2124310
	1"x3/4"	10	<b>3.60</b>	2124311
	1,1/4"x1/2"	10	<b>9.93</b>	2124312
	1,1/4"x3/4"	10	<b>7.35</b>	2124313
	1,1/4"x1"	10	<b>4.28</b>	2124314
	1,1/2"x3/4"		<b>8.44</b>	2124315
	1,1/2"x1"		<b>7.99</b>	2124316
	1,1/2"x1,1/4"		<b>7.03</b>	2124317
	2"x1"		<b>13.88</b>	2124318
	2"x1,1/4"		<b>10.80</b>	2124319
	2"x1,1/2"		<b>11.30</b>	2124320
	<b>330 C</b>			<i>Izjaucams savienojums (I-I)</i>
	1/2"	10	<b>3.48</b>	2124321
	3/4"	10	<b>4.08</b>	2124322
	1"	10	<b>4.69</b>	2124323
	1,1/4"		<b>7.83</b>	2124324
	1,1/2"		<b>10.12</b>	2124325
	2"		<b>16.88</b>	2124326
	<b>331 C</b>			<i>Izjaucams savienojums (I-A)</i>
	1/2"	10	<b>4.42</b>	2124327
	3/4"	10	<b>4.97</b>	2124328
	1"	10	<b>5.94</b>	2124329
	1,1/4"		<b>10.53</b>	2124330
	1,1/2"		<b>12.74</b>	2124331
	2"		<b>19.93</b>	2124332
	<i>Gumijas blīve izjaucamiem savienojumiem</i>			
	<b>03576</b>	1/2"	100	<b>0.32</b> 2166001
		3/4"	100	<b>0.28</b> 2166002
		1"	100	<b>0.46</b> 2166003
		1,1/2"	100	<b>0.66</b> 2166004
		1,1/4"	100	<b>0.74</b> 2166005
	2"	100	<b>0.68</b> 2166006	







		GAB.	EUR	VEIKALS
	<b>340 C</b>			<i>Izjaucams savienojums (konuss (I-I))</i>
	1/2"	10	<b>4.39</b>	2124333
	3/4"	10	<b>4.97</b>	2124334
	1"	10	<b>5.74</b>	2124335
	1,1/4"		<b>9.83</b>	2124336
	1,1/2"		<b>11.49</b>	2124337
	2"		<b>18.66</b>	2124338
	<b>341 C</b>			<i>Izjaucams savienojums (konuss (I-A))</i>
	1/2"	10	<b>4.29</b>	2124339
	3/4"	10	<b>5.17</b>	2124340
	1"	10	<b>6.45</b>	2124341
	1,1/4"		<b>10.17</b>	2124342
	1,1/2"		<b>12.99</b>	2124343
	2"		<b>20.72</b>	2124344
	<b>180 C</b>			<i>Krusts</i>
	1/2"	10	<b>5.27</b>	2124359
	3/4"	10	<b>7.99</b>	2124360
	1"		<b>9.94</b>	2124361
	1,1/4"		<b>11.66</b>	2124362
	1,1/2"		<b>14.86</b>	2124363
	2"		<b>19.44</b>	2124364
	<b>310 C</b>			<i>Kontruzgrieznis</i>
	1/2"		<b>0.86</b>	2124365
	3/4"		<b>0.90</b>	2124366
	1"		<b>1.30</b>	2124367
	1,1/4"		<b>1.92</b>	2124368
	1,1/2"		<b>2.10</b>	2124369
	2"		<b>4.50</b>	2124370
	<b>291 M</b>			<i>Korķis radiatoram kreisā vītne</i>
	1,1/4"x1/2"		<del>1.50</del>	<del>2124407</del>
	1,1/4"x3/4"		<b>1.50</b>	2124408
	<b>291 M</b>			<i>Korķis radiatoram labā vītne</i>
	1,1/4"x1/2"		<b>1.50</b>	2124410
	1,1/4"x3/4"		<b>1.50</b>	2124411
	<b>291 M</b>			<i>Korķis radiatoram labā vītne</i>
	1,1/4"		<b>1.50</b>	2124409
	<b>291 M</b>			<i>Korķis radiatoram kreisā vītne</i>
	1,1/4"		<b>1.50</b>	2124406







## VEIKALS

## VEIKALS

EUR









EUR

201		<i>Lūkums</i>	
	21.3*2.0	1.39	2132001
	26.9*2.6	1.83	2132002
	33.7*2.6	1.90	2132003
	42.4*2.6	2.62	2132004
	48.3*2.6	3.05	2132005
	57.0*2.9	4.44	2132006
	60.3*2.9	5.03	2132007
202		<i>Pāreja</i>	
	26.9-21.3	1.89	2132008
	33.7-21.3	2.52	2132009
	33.7-26.9	2.62	2132010
	42.4-21.3	3.80	2132011
	42.4-26.9	3.73	2132012
	42.4-33.7	2.89	2132013
	48.3-21.3	4.68	2132014
	48.3-26.9	4.35	2132015
	48.3-33.7	3.53	2132016
	48.3-42.4	4.29	2132017
	57.0-26.9	7.81	2132018
	57.0-33.7	7.48	2132019
	57.0-42.4	6.35	2132020
	57.0-48.3	3.75	2132021
	60.3-26.9	5.64	2132022
60.3-33.7	5.69	2132023	
60.3-42.4	4.79	2132024	
60.3-48.3	5.01	2132025	
203		<i>Korķis</i>	
	26.9*2.6	1.10	2132026
	33.7*2.6	1.60	2132027
	42.4*2.6	1.60	2132028
	48.3*2.6	2.37	2132029
	57.0*2.9	3.04	2132030
	60.3*2.9	2.88	2132031
204		<i>Trejšgabals</i>	
	21.3*2.0	7.23	2132032
	26.9*2.6	10.61	2132033
	33.7*2.6	12.22	2132034
	42.4*2.6	13.35	2132035
	48.3*2.6	14.64	2132036
	57.0*2.9	21.99	2132037
205		<i>Uzmava</i>	
	1/2"	0.65	2132038
	3/4"	0.91	2132039
	1"	1.14	2132040
	1 1/4"	1.56	2132041
	1 1/2"	1.84	2132042
	2"	2.53	2132043
206		<i>Pāreja uz vītņi</i>	
	1/2"x40	0.56	2132044
	3/4"x50	0.67	2132045
	1"x60	0.91	2132046
	1 1/4"x60	1.26	2132047
	1 1/2"x60	1.73	2132048
	2"x60	2.17	2132049

312 C		<i>Īsā vītne (cinkota)</i>	
	1/2"x40	1.11	2124386
	1/2"x60	0.88	2124424
	1/2"x100	1.45	2124387
	1/2"x150	2.17	2124388
	3/4"x50	1.19	2124389
	3/4"x100	2.21	2124390
	3/4"x150	2.73	2124391
	1"x60	1.75	2124413
	1"x100	2.90	2124392
	1"x150	4.24	2124393
	1,1/4"x70	2.06	2124400
	1,1/2"x70	3.05	2124401
2"x70	3.69	2124402	
312 M		<i>Īsā vītne (melna)</i>	
	1/2"x40	0.60	2124374
	1/2"x60	0.67	2124423
	1/2"x100	1.41	2124375
	1/2"x150	1.71	2124376
	3/4"x50	0.72	2124377
	3/4"x100	1.76	2124378
	3/4"x150	2.75	2124379
	1"x60	0.93	2124380
	1"x100	2.81	2124381
	1"x150	4.23	2124382
	1,1/4"x70	1.87	2124394
	1,1/2"x70	2.12	2124395
2"x70	3.29	2124396	
311 C		<i>Garā vītne (cinkota)</i>	
	1/2"x100	1.60	2124383
	3/4"x110	2.19	2124384
	1"x120	2.79	2124385
	1,1/4"x130	4.38	2124403
	1,1/2"x140	5.63	2124404
	2"x150	7.83	2124405
311 M		<i>Garā vītne (melna)</i>	
	1/2"x100	1.31	2124371
	3/4"x110	1.60	2124372
	1"x120	2.51	2124373
	1,1/4"x130	3.48	2124397
	1,1/2"x140	4.09	2124398
	2"x150	7.52	2124399
GARUMS 3 M		<i>Tērauda caurule, melna</i>	
	DN15(21.3x2.6)	5.24	2532008
	DN20(26.9x2.6)	6.24	2532009
	DN25(33.7x3.2)	11.00	2532010
	DN32(42.3x3.2)	13.61	2532020
	DN40(48.3x3.2)	15.74	2532012
	DN50(60.3x3.2)	19.66	2532013
DN65(76.1x3.2)	22.71	2532023	
GARUMS 3 M		<i>Tērauda caurule, cinkota</i>	
	DN15(21.3x2.6)	5.73	2532025
	DN20(26.9x2.6)	8.21	2532016
	DN25(33.7x3.2)	11.49	2532014
	DN32(42.3x3.2)	13.95	2532015
	DN40(48.3x3.2)	16.86	2532021
	DN50(60.3x3.2)	21.62	2532022







## VEIKALS













GAB. EUR















	<b>900</b> PPR caurule PN 20			
	4	0.55	16x2,7	3936092
	4	1.22	20x3,4	3936093
	4	1.81	25x4,2	3936094
	4	3.21	32x5,4	3936095
	4	5.02	40x6,7	3936145
	4	8.13	50x8,4	3936146
	<b>918</b> PPR ar alumīnija slāni caurule PN20			
	4	1.95	20x3,4	3936142
	4	2.75	25x4,2	3936143
	4	4.16	32x5,4	3936144
	4	6.32	40x6,7	3936168
	4	9.52	50x8,4	3936169
	4	15.21	63x10,5	3936170
	<b>919</b> PPR caurule PN 20 ar šķiedru			
	4	1.20	20x2,8	3936161
	4	1.90	25x3,5	3936162
	4	3.25	32x4,4	3936163
	4	4.62	40x5,5	3936164
	4	6.61	50x6,9	3936165
	<b>901</b> PPR līkums 45° I-I			
	50	0.22	dn 16	3936005
	40	0.19	dn 20	3936006
	20	0.24	dn 25	3936007
		0.44	dn 32	3936008
		0.77	dn 40	3936106
		1.42	dn 50	3936107
	3.00	dn 63	3936108	
	<b>901</b> PPR līkums 90° I-I			
	50	0.19	dn 20	3936010
	40	0.31	dn 25	3936011
	20	0.42	dn 32	3936012
	10	0.82	dn 40	3936109
	4	1.55	dn 50	3936110
	<b>901</b> PPR līkums 45° I-A			
	200	0.31	dn 16	3936013
	50	0.62	dn 20	3936014
	50	0.65	dn 25	3936015
	10	0.96	dn 32	3936016
	<b>901</b> PPR līkums 90° I-A			
	100	0.23	dn 16	3936017
		0.31	dn 20	3936018
		0.46	dn 25	3936019
		0.80	dn 32	3936020
	<b>907</b> PPR līkums 90° IV			
	10	1.86	16x1/2i	3936053
	20	1.38	20x1/2i	3936054
	10	1.90	20x3/4i	3936055
	10	1.60	25x1/2i	3936056
	50	1.79	25x3/4i	3936057
	5	2.69	32x3/4i	3936058
	<b>907</b> PPR līkums 90° AV			
	10	2.00	16x1/2ā	3936060
	10	1.46	20x1/2ā	3936061
	10	2.17	20x3/4ā	3936062
	10	1.81	25x1/2ā	3936063
	10	2.20	25x3/4ā	3936064
		4.14	32x3/4ā	3936065
	6.59	32x1"ā	3936066	

## VEIKALS

GAB. EUR

	<b>911</b> PPR pāreja IV			
	50	1.46	16x1/2i	3936043
	20	1.23	20x1/2i	3936044
	20	1.90	20x3/4i	3936045
	20	1.27	25x1/2i	3936046
	20	1.52	25x3/4i	3936047
	20	1.71	32x1/2i	3936148
	10	2.21	32x3/4i	3936158
	10	3.53	32x1i	3936104
	5	6.39	40x1,1/4i	3936136
		8.19	50x1,1/2i	3936137
	12.04	63x2i	3936138	
	<b>911</b> PPR pāreja AV			
	20	1.38	20x1/2ā	3936049
		2.09	20x3/4ā	3936050
	20	1.66	25x1/2ā	3936051
	10	2.02	25x3/4ā	3936052
	10	2.49	32x3/4"	3936157
	5	3.93	32x1ā	3936105
	5	8.28	40x1,1/4ā	3936139
		12.68	50x1,1/2ā	3936140
	4	17.07	63x2ā	3936141
		<b>904</b> PPR trejgabals		
20		0.19	dn 16	3936021
40		0.22	dn 20	3936022
20		0.37	dn 25	3936023
10		0.54	dn 32	3936024
5		1.13	dn 40	3936112
		2.01	dn 50	3936113
	<b>904</b> PPR trejgabals			
		0.54	25/16/25	3936026
		0.32	25/20/25	3936027
	30	0.51	32/20/32	3936028
	20	0.60	32/25/32	3936029
	25	0.98	40/20/40	3936115
		0.98	40/25/40	3936116
	10	1.03	40/32/40	3936117
	10	2.48	50/20/50	3936118
		2.42	50/25/50	3936119
		2.47	50/32/50	3936120
	<b>905</b> PPR trejgabals AV			
	10	2.19	16x1/2āx16	3936067
		1.60	20x1/2āx20	3936068
		2.06	20x3/4āx20	3936069
	10	1.68	25x1/2āx25	3936070
		2.03	25x3/4āx25	3936071
		2.64	32x1/2"x32	3936185
	3.14	32x3/4āx32	3936072	
	4.59	32x1"āx32	3936073	
	<b>905</b> PPR trejgabals IV			
	10	1.29	20x1/2ix20	3936075
	10	1.57	20x3/4ix20	3936076
	10	1.39	25x1/2ix25	3936077
	10	1.83	25x3/4ix25	3936078
		2.23	32x1/2"x32	3936184
		2.68	32x3/4ix32	3936079
		5.67	32x1"ix32	3936080

		VEIKALS		
		GAB.	EUR	
	<b>908</b>	<i>PPR mufe</i>		
	100	<b>0.15</b>	dn 20	<b>3936031</b>
	50	<b>0.19</b>	dn 25	<b>3936032</b>
	30	<b>0.29</b>	dn 32	<b>3936033</b>
	10	<b>0.51</b>	dn 40	<b>3936122</b>
	10	<b>1.03</b>	dn 50	<b>3936123</b>
	9	<b>1.77</b>	dn 63	<b>3936124</b>
	<b>903</b>	<i>PPR mufe ar pāreju</i>		
		<b>0.50</b>	16/25	<b>3936035</b>
		<b>0.16</b>	20/25	<b>3936036</b>
	50	<b>0.22</b>	20/32	<b>3936037</b>
	20	<b>0.32</b>	25/32	<b>3936038</b>
	40	<b>0.31</b>	20/40	<b>3936125</b>
	20	<b>0.32</b>	25/40	<b>3936126</b>
		<b>0.48</b>	32/40	<b>3936127</b>
		<b>0.98</b>	20/50	<b>3936150</b>
		<b>0.81</b>	32/50	<b>3936128</b>
		<b>1.24</b>	40/50	<b>3936129</b>
		<b>0.92</b>	32/63	<b>3936130</b>
	10	<b>1.16</b>	40/63	<b>3936131</b>
	5	<b>1.30</b>	50/63	<b>3936132</b>
	<b>912</b>	<i>PPR uzdeva ar pāreju IV</i>		
	400	<b>0.22</b>	25/20	<b>3936336</b>
	200	<b>0.31</b>	32/20	<b>3936337</b>
	200	<b>0.28</b>	32/25	<b>3936338</b>
	<b>910</b>	<i>PPR korķis</i>		
	100	<b>0.12</b>	dn 20	<b>3936040</b>
		<b>0.14</b>	dn 25	<b>3936041</b>
	10	<b>0.23</b>	dn 32	<b>3936042</b>
		<b>0.41</b>	dn 40	<b>3936133</b>
		<b>1.20</b>	dn 50	<b>3936134</b>
		<b>1.60</b>	dn 63	<b>3936135</b>
	<b>920</b>	<i>PPR korķis iekšējais</i>		
	<b>0.34</b>	dn 32	<b>3936195</b>	
	<b>906</b>	<i>PPR apeja</i>		
		<b>0.31</b>	dn 16	<b>3936001</b>
		<b>0.70</b>	dn 20	<b>3936002</b>
		<b>0.98</b>	dn 25	<b>3936003</b>
		<b>1.52</b>	dn 32	<b>3936004</b>
	<b>902</b>	<i>PPR līkums ar sienas stiprinājumu IV</i>		
	10	<b>1.41</b>	20x1/2i	<b>3936082</b>
		<b>2.59</b>	20x3/4i	<b>3936083</b>
		<b>1.63</b>	25x1/2i	<b>3936084</b>
	10	<b>2.59</b>	25x3/4i	<b>3936085</b>
	<b>902</b>	<i>PPR līkums ar sienas stiprinājumu AV</i>		
		<b>1.78</b>	20x1/2ā	<b>3936087</b>
		<b>2.96</b>	25x1/2ā	<b>3936089</b>
	10	<b>3.27</b>	25x3/4ā	<b>3936090</b>
	<b>914</b>	<i>PPR kompensācijas cilpa</i>		
		<b>2.03</b>	dn 16	<b>3936096</b>
		<b>2.27</b>	dn 20	<b>3936097</b>
	<b>915</b>	<i>PPR izjaucama uzdeva IV</i>		
	20	<b>2.74</b>	20x1/2	<b>3936100</b>
		<b>3.52</b>	25x3/4	<b>3936101</b>
		<b>6.89</b>	32x1"	<b>3936186</b>
	<b>916</b>	<i>PPR izjaucama uzdeva AV</i>		
		<b>4.78</b>	20x1/2	<b>3936102</b>
		<b>5.10</b>	25x3/4	<b>3936103</b>
		<b>7.06</b>	32x1"	<b>3936187</b>
	<b>922</b>	<i>PPR pāreja ar saskrūvi IV</i>		
		<b>2.21</b>	20x1/2"	<b>3936178</b>
		<b>3.03</b>	25x3/4"	<b>3936182</b>
		<b>6.80</b>	32x1"	<b>3936301</b>

		VEIKALS		
		GAB.	EUR	
	<b>923</b>	<i>PPR pāreja līkums ar saskrūvi IV</i>		
		<b>1.93</b>	20x1/2"	<b>3936177</b>
		<b>2.87</b>	25x3/4"	<b>3936183</b>
	<b>921</b>	<i>PPR saskrūve plastmasa IV</i>		
	200	<b>1.53</b>	dn 20	<b>3936342</b>
	100	<b>1.94</b>	dn 25	<b>3936343</b>
	60	<b>2.36</b>	dn 32	<b>3936344</b>
	<b>924</b>	<i>PPR apeja īsā</i>		
		<b>0.47</b>	dn 20	<b>3936152</b>
		<b>0.47</b>	dn 25	<b>3936153</b>
		<b>0.92</b>	dn 32	<b>3936154</b>
	<b>925</b>	<i>PPR zemapmetuma līkums I-V</i>		
		<b>3.47</b>	20x1/2"	<b>3936091</b>
	<b>909</b>	<i>PPR sienas montāžas komplekts</i>		
		<b>6.34</b>	20x1/2"	<b>3936167</b>
	<b>4476 A/10</b>	<i>Montāžas plāksne ar 2 PPR līkumiem</i>		
	10	<b>9.78</b>	1/2"x20	<b>3936329</b>
	<b>928</b>	<i>Gružu filtrs PPR</i>		
	100	<b>2.08</b>	1/2"	<b>3936339</b>
	80	<b>2.92</b>	3/4"	<b>3936340</b>
	35	<b>5.28</b>	1"	<b>3936341</b>
	<b>927</b>	<i>PPR lodveida ventilis ar saskrūvi</i>		
	10	<b>13.54</b>	25x3/4"	<b>3936333</b>
	<b>917</b>	<i>PPR lodveida ventilis (zemapmetuma)</i>		
	10	<b>3.25</b>	dn 20	<b>3936323</b>
	5	<b>4.65</b>	dn 25	<b>3936324</b>
	5	<b>7.27</b>	dn 32	<b>3936325</b>
		<b>13.92</b>	dn 40	<b>3936326</b>
	2	<b>21.88</b>	dn 50	<b>3936327</b>
	1	<b>38.90</b>	dn 63	<b>3936328</b>
	<b>921 PPR</b>	<i>Šķēres PPR caurulēm 0-42mm nerūsējoša tērauda asmenis</i>		
		<b>14.73</b>		<b>3435001</b>
		<b>14.46</b>		<b>3435002</b>
	<b>913- PLAKANS</b>	<i>Lodāmurs 1000W (komplektā ar uzgaļiem 20-63)</i>		
		<b>69.91</b>	1000W	<b>7635001</b>
		<b>55.08</b>	800W	<b>7635018</b>
	<b>913-apalš</b>	<i>Lodāmurs (komplektā ar uzgaļiem 16-32)</i>		
		<b>78.45</b>	1200W	<b>7635014</b>
		<b>73.61</b>	800W	<b>7635020</b>
	<b>912-uzg. apalš</b>	<i>Lodāmura PPR uzgali</i>		
		<b>8.24</b>	20	<b>9735006</b>
		<b>9.00</b>	25	<b>9735007</b>
		<b>9.81</b>	32	<b>9735008</b>
	<b>912-uzg. plakans</b>	<i>Lodāmura PPR uzgali</i>		
		<b>12.36</b>	16	<b>9735001</b>
		<b>9.59</b>	20	<b>9735002</b>
		<b>10.68</b>	25	<b>9735003</b>
		<b>13.31</b>	32	<b>9735004</b>
		<b>4.41</b>	40	<b>7635007</b>
		<b>5.39</b>	50	<b>7635008</b>
	<b>6.37</b>	63	<b>7635009</b>	



















VEIKALS

EUR

VEIKALS

EUR























<b>1509068</b>		<i>Likums 45° I-I</i>	
	15x15	<b>2.31</b>	<b>2215070</b>
	18x18	<b>2.41</b>	<b>2215007</b>
	22x22	<b>2.50</b>	<b>2215008</b>
	28x28	<b>3.40</b>	<b>2215009</b>
<b>1509068</b>		<i>Likums 45° I-A</i>	
	15x15	<b>2.17</b>	<b>2215010</b>
	18x18	<b>2.26</b>	<b>2215011</b>
	22x22	<b>2.40</b>	<b>2215012</b>
	28x28	<b>3.54</b>	<b>2215013</b>
<b>1509068</b>		<i>Likums 90° I-I</i>	
	15x15	<b>1.92</b>	<b>2215014</b>
	18x18	<b>2.07</b>	<b>2215015</b>
	22x22	<b>2.38</b>	<b>2215016</b>
	28x28	<b>3.25</b>	<b>2215017</b>
<b>1509068</b>		<i>Likums 90° I-A</i>	
	15x15	<b>2.02</b>	<b>2215018</b>
	18x18	<b>2.25</b>	<b>2215019</b>
	22x22	<b>2.60</b>	<b>2215020</b>
	28x28	<b>3.22</b>	<b>2215071</b>
<b>1509045</b>		<i>Pāreja AV</i>	
	15x1/2"	<b>3.36</b>	<b>2215021</b>
	18x1/2"	<b>3.93</b>	<b>2215023</b>
	18x3/4"	<b>4.28</b>	<b>2215024</b>
	22x1/2"	<b>4.09</b>	<b>2215025</b>
	22x3/4"	<b>4.61</b>	<b>2215072</b>
	28x1/2"	<b>5.43</b>	<b>2215026</b>
	28x3/4"	<b>5.61</b>	<b>2215027</b>
28x1"	<b>5.77</b>	<b>2215028</b>	
<b>1509044</b>		<i>Pāreja IV</i>	
	15x1/2"	<b>2.57</b>	<b>2215073</b>
	18x1/2"	<b>3.06</b>	<b>2215033</b>
	18x3/4"	<b>4.93</b>	<b>2215034</b>
	22x1/2"	<b>3.92</b>	<b>2215035</b>
	22x3/4"	<b>4.60</b>	<b>2215074</b>
	28x1/2"	<b>5.78</b>	<b>2215037</b>
	28x3/4"	<b>4.60</b>	<b>2215038</b>
	28x1"	<b>5.94</b>	<b>2215036</b>
<b>1509057</b>		<i>Krusts</i>	
	15x15	<b>9.16</b>	<b>2215029</b>
	18x15	<b>9.62</b>	<b>2215079</b>
	18x18	<b>9.62</b>	<b>2215030</b>
	22x15	<b>10.55</b>	<b>2215080</b>
	22x18	<b>10.55</b>	<b>2215081</b>
	22x22	<b>10.54</b>	<b>2215031</b>
28x28	<b>10.88</b>	<b>2215032</b>	
<b>1509022</b>		<i>Apeja</i>	
	15	<b>3.72</b>	<b>2215082</b>
	18	<b>3.78</b>	<b>2215083</b>
	22	<b>4.36</b>	<b>2215084</b>











<b>1509245</b>		<i>Savienojums I-I</i>	
	15x15	<b>1.42</b>	<b>2215039</b>
	18x18	<b>1.47</b>	<b>2215040</b>
	22x22	<b>1.70</b>	<b>2215041</b>
	28x28	<b>1.99</b>	<b>2215042</b>
<b>1509221</b>		<i>Savienojums reducēts I-A</i>	
	18x15	<b>1.32</b>	<b>2215043</b>
	22x15	<b>1.32</b>	<b>2215044</b>
	22x18	<b>1.43</b>	<b>2215045</b>
	28x18	<b>2.16</b>	<b>2215046</b>
	28x22	<b>1.84</b>	<b>2215047</b>
<b>1509080</b>		<i>Remontuzmava</i>	
	15x15	<b>1.59</b>	<b>2215075</b>
	18x18	<b>1.84</b>	<b>2215076</b>
	22x22	<b>2.13</b>	<b>2215077</b>
	28x28	<b>2.70</b>	<b>2215048</b>
<b>1509042</b>		<i>Uzmava ar pāreju I-I</i>	
	18x15	<b>2.33</b>	<b>2215085</b>
	22x15	<b>2.37</b>	<b>2215086</b>
	22x18	<b>2.59</b>	<b>2215087</b>
	28x15	<b>4.03</b>	<b>2215088</b>
	28x18	<b>3.85</b>	<b>2215089</b>
	28x22	<b>3.39</b>	<b>2215090</b>
<b>1509257</b>		<i>Trejšgabals</i>	
	15	<b>3.86</b>	<b>2215078</b>
	18	<b>4.14</b>	<b>2215049</b>
	22	<b>4.47</b>	<b>2215050</b>
	28	<b>5.96</b>	<b>2215051</b>
<b>1509258</b>		<i>Trejšgabals IV</i>	
	15x1/2"	<b>5.50</b>	<b>2215052</b>
	18x1/2"	<b>5.66</b>	<b>2215053</b>
	22x1/2"	<b>6.22</b>	<b>2215054</b>
	22x3/4"	<b>6.51</b>	<b>2215055</b>
	28x1/2"	<b>7.25</b>	<b>2215057</b>
	28x3/4"	<b>8.66</b>	<b>2215058</b>
	28x1"	<b>10.08</b>	<b>2215056</b>
<b>1509260</b>		<i>Trejšgabals ar pāreju</i>	
	15x22x15	<b>4.63</b>	<b>2215059</b>
	18x15x18	<b>4.14</b>	<b>2215060</b>
	18x22x18	<b>4.15</b>	<b>2215061</b>
	22x15x22	<b>4.40</b>	<b>2215062</b>
	22x18x22	<b>4.47</b>	<b>2215063</b>
	28x15x28	<b>5.92</b>	<b>2215064</b>
	28x18x28	<b>6.12</b>	<b>2215065</b>
	28x22x28	<b>6.43</b>	<b>2215066</b>
	<b>1509250</b>		<i>Korķis</i>
	15	<b>2.66</b>	<b>2215067</b>
	18	<b>2.81</b>	<b>2215068</b>
	22	<b>3.01</b>	<b>2215069</b>
	28	<b>4.46</b>	<b>2215006</b>
<b>1530207</b>		<i>Karbons caurule</i>	
	15	<b>2.00</b>	<b>2215000</b>
	18	<b>2.39</b>	<b>2215001</b>
	22	<b>3.19</b>	<b>2215002</b>
	28	<b>4.15</b>	<b>2215003</b>
	35	<b>5.92</b>	<b>2215004</b>
	42	<b>7.53</b>	<b>2215005</b>













# PLASTMASAS VEIDGABALI POLIETILĒNA CAURULEI

		GAB.	EUR	VEIKALS			GAB.	EUR	VEIKALS
	<b>510</b>			<i>Uzmava</i>					
	20x20	20	<b>2.18</b>	<b>9018001</b>					
	25x25	10	<b>2.58</b>	<b>9018002</b>					
	32x32	10	<b>3.36</b>	<b>9018003</b>					
	40x40	5	<b>5.45</b>	<b>9018004</b>					
	50x50	5	<b>7.44</b>	<b>9018005</b>					
	63x63	5	<b>10.28</b>	<b>9018006</b>					
	<b>511</b>			<i>Pāreja (ārējā vītne - caurule)</i>					
	20x1/2"	20	<b>1.21</b>	<b>9018007</b>					
	20x3/4"	20	<b>1.21</b>	<b>9018008</b>					
	25x1/2"	10	<b>1.43</b>	<b>9018009</b>					
	25x3/4"	10	<b>1.43</b>	<b>9018010</b>					
	25x1"	10	<b>1.43</b>	<b>9018011</b>					
	32x3/4"	10	<b>1.82</b>	<b>9018012</b>					
	32x1"	10	<b>1.82</b>	<b>9018013</b>					
	32x1,1/4"	10	<b>2.04</b>	<b>9018014</b>					
	40x1"	5	<b>3.40</b>	<b>9018015</b>					
	40x1,1/4"	5	<b>3.40</b>	<b>9018016</b>					
	40x1,1/2"	5	<b>3.40</b>	<b>9018017</b>					
50x1,1/2"	5	<b>4.43</b>	<b>9018018</b>						
63x2"	5	<b>6.28</b>	<b>9018019</b>						
	<b>512</b>			<i>Uzmava ar pāreju</i>					
	25x20	20	<b>2.36</b>	<b>9018020</b>					
	32x25	10	<b>3.07</b>	<b>9018021</b>					
	40x32	5	<b>5.44</b>	<b>9018022</b>					
	50x40	5	<b>6.85</b>	<b>9018023</b>					
	63x40	5	<b>9.68</b>	<b>9018024</b>					
63x50	5	<b>9.69</b>	<b>9018025</b>						
	<b>513</b>			<i>Līkums 90°</i>					
	20x20	20	<b>2.19</b>	<b>9018026</b>					
	25x25	10	<b>2.62</b>	<b>9018027</b>					
	32x32	10	<b>3.25</b>	<b>9018028</b>					
	40x40	5	<b>5.69</b>	<b>9018029</b>					
	50x50	5	<b>7.97</b>	<b>9018030</b>					
63x63	5	<b>10.10</b>	<b>9018031</b>						
	<b>514</b>			<i>Trejgabals</i>					
	20x20x20	20	<b>2.84</b>	<b>9018032</b>					
	25x25x25	10	<b>3.71</b>	<b>9018033</b>					
	32x32x32	10	<b>4.89</b>	<b>9018034</b>					
	40x40x40	5	<b>7.97</b>	<b>9018035</b>					
	50x50x50	5	<b>10.86</b>	<b>9018036</b>					
63x63x63	5	<b>15.45</b>	<b>9018037</b>						
	<b>515</b>			<i>Trejgabals ar iekšējo vītņi</i>					
	20x1/2"x20	20	<b>2.41</b>	<b>9018038</b>					
	25x1/2"x25	10	<b>3.11</b>	<b>9018039</b>					
	25x3/4"x25	10	<b>3.11</b>	<b>9018040</b>					
	32x3/4"x32	10	<b>4.16</b>	<b>9018041</b>					
	32x1"x32	10	<b>4.16</b>	<b>9018042</b>					
	40x1"x40	5	<b>8.40</b>	<b>9018043</b>					
40x1,1/4"x40	5	<b>8.40</b>	<b>9018044</b>						
50x1,1/2"x50	5	<b>10.70</b>	<b>9018045</b>						
63x2"x63	5	<b>13.43</b>	<b>9018046</b>						
	<b>521</b>			<i>Korkis</i>					
	20	20	<b>1.44</b>	<b>9018060</b>					
	25	10	<b>1.66</b>	<b>9018061</b>					
	32	10	<b>1.96</b>	<b>9018062</b>					
	40	5	<b>3.34</b>	<b>9018063</b>					
	50	5	<b>4.95</b>	<b>9018064</b>					
63	5	<b>6.70</b>	<b>9018065</b>						
	<b>505</b>			<i>Uzmavas atzars</i>					
	20x1/2"		<b>2.00</b>	<b>9018086</b>					
	25x1/2"		<b>2.05</b>	<b>9018087</b>					
	25x3/4"		<b>2.05</b>	<b>9018088</b>					
	32x3/4"		<b>3.01</b>	<b>9018089</b>					
32x1"		<b>2.36</b>	<b>9018090</b>						
	<b>518</b>			<i>Līkums 90° ar iekšējo vītņi</i>					
	20x1/2"	20	<b>1.80</b>	<b>9018047</b>					
	25x3/4"	10	<b>2.29</b>	<b>9018048</b>					
	32x3/4"	10	<b>2.68</b>	<b>9018049</b>					
	32x1"	10	<b>2.68</b>	<b>9018050</b>					
	40x1,1/4"	5	<b>5.47</b>	<b>9018051</b>					
50x1,1/2"	5	<b>7.26</b>	<b>9018052</b>						
63x2"	5	<b>9.66</b>	<b>9018053</b>						
	<b>519</b>			<i>Līkums 90° ar ārējo vītņi</i>					
	20x1/2"	20	<b>1.58</b>	<b>9018054</b>					
	25x1/2"	20	<b>1.52</b>	<b>9018092</b>					
	25x3/4"	10	<b>1.91</b>	<b>9018055</b>					
	32x1"	10	<b>2.41</b>	<b>9018056</b>					
	40x1,1/4"	5	<b>4.08</b>	<b>9018057</b>					
50x1,1/2"	5	<b>5.85</b>	<b>9018058</b>						
63x2"	5	<b>8.09</b>	<b>9018059</b>						
	<b>523</b>			<i>Trejgabals ar pāreju</i>					
	25x20	10	<b>4.44</b>	<b>9018066</b>					
	32x25	10	<b>5.01</b>	<b>9018067</b>					
	40x32	1	<b>10.55</b>	<b>9018068</b>					
	50x40	1	<b>14.18</b>	<b>9018069</b>					
63x50	1	<b>19.11</b>	<b>9018070</b>						
	<b>601</b>			<i>Pāreja (iekšējā vītne - caurule)</i>					
	20x1/2"	20	<b>1.49</b>	<b>9018071</b>					
	25x1/2"	10	<b>1.65</b>	<b>9018083</b>					
	25x3/4"	10	<b>1.65</b>	<b>9018072</b>					
	25x1"	10	<b>1.65</b>	<b>9018084</b>					
	32x3/4"	10	<b>2.12</b>	<b>9018085</b>					
32x1"	10	<b>2.12</b>	<b>9018073</b>						
40x1,1/4"	5	<b>3.13</b>	<b>9018074</b>						
50x1,1/2"	5	<b>4.53</b>	<b>9018075</b>						
63x2"	5	<b>6.36</b>	<b>9018076</b>						
	<b>335</b>			<i>Lodveida ventilis PVC</i>					
	DN20		<b>12.00</b>	<b>9018093</b>					
	DN25		<b>12.00</b>	<b>9018094</b>					
DN32		<b>14.29</b>	<b>9018095</b>						
	<b>GHI10</b>			<i>Uzgrieznis</i>					
	20		<b>0.52</b>	<b>9018077</b>					
	25		<b>0.77</b>	<b>9018078</b>					
	32		<b>0.93</b>	<b>9018079</b>					
	40		<b>1.59</b>	<b>9018080</b>					
	50		<b>2.03</b>	<b>9018081</b>					
63		<b>2.87</b>	<b>9018082</b>						
	<b>ARG10</b>			<i>Ieliktnis</i>					
	20		<b>0.40</b>	<b>9066001</b>					
	25		<b>0.48</b>	<b>9066002</b>					
	32		<b>0.88</b>	<b>9066003</b>					
	40		<b>1.01</b>	<b>9066004</b>					
	50		<b>1.26</b>	<b>9066005</b>					
63		<b>2.29</b>	<b>9066006</b>						
	<b>GUA11</b>			<i>Bļīve</i>					
	Dn20		<b>0.42</b>	<b>9066007</b>					
	Dn25		<b>0.45</b>	<b>9066008</b>					
	Dn32		<b>0.65</b>	<b>9066009</b>					
	Dn40		<b>0.80</b>	<b>9066010</b>					
	Dn50		<b>0.87</b>	<b>9066011</b>					
Dn63		<b>1.04</b>	<b>9066012</b>						
				<i>Polietilēna caurule rullī</i>					
	20x2,0;	100 m	<b>1.04</b>	<b>2518001</b>					
	20x2,0;	500 m	<b>0.94</b>	<b>2518012</b>					
	25x2,3;	100 m	<b>1.33</b>	<b>2518002</b>					
	25x2,3;	500 m	<b>1.33</b>	<b>2518013</b>					
	32x3,0;	100 m	<b>1.57</b>	<b>2518003</b>					
	32x3,0;	500 m	<b>1.57</b>	<b>2518014</b>					
	40x3,0;	100 m	<b>2.30</b>	<b>4218001</b>					
	40x3,7;	100 m	<b>2.89</b>	<b>2518005</b>					
	50x3,0;	100 m	<b>2.69</b>	<b>4218003</b>					
	50x4,6;	100 m	<b>4.33</b>	<b>2518004</b>					
	63x3,8;	100 m	<b>4.90</b>	<b>2518006</b>					















## RADIATORU VENTIĻI VENTIĻI DVIELU ŽĀVĒTĀJIEM













GAB. <b>EUR VEIKALS</b>					GAB. <b>EUR VEIKALS</b>								
<b>KAS0401303</b>	<i>Radiatora ventilis, leņķa</i>		1/2"	1	<b>4.29</b>	3920001	<b>3760</b>	<i>Ventīlis, leņķa, rokas regulācija</i>		1/2"	1	<b>19.36</b>	2120021
<b>KAS0405310</b>	<i>Radiatora ventilis, leņķa</i>		3/4"	1	<b>2.67</b>	3920002	<b>3761</b>	<i>Ventīlis, leņķa, labais</i>		1/2"	1	<b>28.05</b>	2120022
<b>KAS042301</b>	<i>Radiatora ventilis, taisns</i>		1/2"	1	<b>4.83</b>	3920003	<b>3762</b>	<i>Ventīlis, leņķa, kreisais</i>		1/2"	1	<b>26.57</b>	2120023
<b>KAS0402303</b>	<i>Atpakaļgaitas ventilis, taisnais</i>		1/2"	1	<b>5.48</b>	3920005	<b>3763</b>	<i>Ventīlis, leņķa</i>		1/2"	1	<b>11.78</b>	2120024
<b>KAS0404305</b>	<i>Atpakaļgaitas ventilis, leņķa</i>		1/2"	1	<b>4.83</b>	3920004	<b>3764</b>	<i>Ventīlis, leņķa ar slēptu pievadu</i>		1/2"	1	<b>11.29</b>	2120025
<b>KAS8102005</b>	<i>Termo galva, hromēta</i>		1/2"	1	<b>7.41</b>	3920006	<b>3770</b>	<i>Termogalva</i>		1/2"	1	<b>25.56</b>	2120026
<b>KAS8102004</b>	<i>Termo galva, balta</i>		1/2"	1	<b>7.04</b>	3920007	<b>3765</b>	<i>Ventīlis, leņķa, termo</i>		1/2"	1	<b>21.51</b>	2120027
<b>KAS1314014</b>	<i>Termoventīlis, leņķa, PEX Bez galvas</i>		1/2"	1	<b>2.72</b>	3920008	<b>3766</b>	<i>Ventīlis, leņķa, labais, termo</i>		1/2"	1	<b>30.88</b>	2120028
<b>KAS1309007</b>	<i>Termoventīlis, aksiālais ar galvu</i>		1/2"	1	<b>13.47</b>	3920010	<b>3767</b>	<i>Ventīlis, leņķa, kreisais, termo</i>		1/2"	1	<b>30.88</b>	2120029
<b>KAS1304010</b>	<i>Termoventīlis, taisnais Ar galvu</i>		1/2"	1	<b>12.70</b>	3920030	<b>3772</b>	<i>Pāreja daudzslāņu caurulei komplekts</i>		16x1/2"	1	<b>12.01</b>	0925169
<b>KAS1302305</b>	<i>Radiatoru ventiļu komplekts termostats</i>		1/2"		<b>16.66</b>	3920032	<b>3774</b>	<i>Pāreja misiņa caurulei komplekts</i>		15 x 1/2"	1	<b>9.81</b>	0925168
							<b>3789</b>	<i>Pievads divieļu žāvētājam 15 cm</i>		1/2"x15	1	<b>5.65</b>	2110003

	GAB.	EUR	VEIKALS
	<b>7750</b> <i>Lodveida ventilis (I-I)</i>		
	3/8"	25	<b>6.15</b> 0620141
	1/2"	25	<b>5.39</b> 0620001
	3/4"	20	<b>7.40</b> 0620002
	1"	10	<b>11.09</b> 0620003
	1,1/4"		<b>19.92</b> 0620048
	1,1/2"		<b>30.68</b> 0620049
2"		<b>48.94</b> 0620050	
	<b>7752</b> <i>Lodveida ventilis (I-I)</i>		
	3/8"	25	<b>6.12</b> 0620130
	1/2"	25	<b>5.39</b> 0620004
	3/4"	20	<b>7.36</b> 0620005
1"	10	<b>11.19</b> 0620051	
	<b>7951</b> <i>Lodveida ventilis (I-I)</i>		
	4"		<b>111.50</b> 0620102
	<b>7605</b> <i>Lodveida ventilis (I-A)</i>		
	1/2"	20	<b>6.23</b> 0620026
	3/4"	15	<b>9.01</b> 0620027
	1"	10	<b>13.54</b> 0620028
	1,1/4"		<b>21.12</b> 0620052
	1,1/2"		<b>31.65</b> 0620053
2"		<b>46.73</b> 0620054	
	<b>7607</b> <i>Lodveida ventilis (I-A)</i>		
	3/8"	25	<b>6.34</b> 0620010
	1/2"	20	<b>6.26</b> 0620029
	3/4"	15	<b>8.94</b> 0620030
1"	10	<b>13.52</b> 0620055	
	<b>7645</b> <i>Lodveida ventilis (A-A)</i>		
	1/2"	20	<b>6.42</b> 0620006
	3/4"	15	<b>9.48</b> 0620007
	1"	10	<b>13.92</b> 0620056
	1,1/4"		<b>22.70</b> 0620057
	1,1/2"		<b>33.85</b> 0620058
2"		<b>55.86</b> 0620059	
	<b>7647</b> <i>Lodveida ventilis (A-A)</i>		
	1/2"	20	<b>6.42</b> 0620008
	3/4"	15	<b>9.45</b> 0620009
1"	10	<b>14.02</b> 0620060	
	<i>Lodveida krāns ar pieslēguzgriezni</i>		
	<b>7650</b>		
	1/2"	15	<b>9.04</b> 0620038
	3/4"	10	<b>13.43</b> 0620039
	1"	6	<b>19.06</b> 0620040
1,1/4"	5	<b>30.91</b> 0620041	
	<b>7950</b> <i>Lodveida ventilis gāzei (I-I)</i>		
	1/2"	15	<b>8.91</b> 0620135
	<b>7952</b> <i>Lodveida ventilis gāzei (I-I)</i>		
	1/2"	15	<b>9.03</b> 0620134

















	GAB.	EUR	VEIKALS
	<b>7955</b> <i>Lodveida ventilis gāzei (I-A)</i>		
	1/2"	15	<b>8.38</b> 0620132
	<b>7957</b> <i>Lodveida ventilis gāzei (I-A)</i>		
	1/2"	15	<b>8.69</b> 0620133
	<b>7956</b> <i>Lodveida ventilis</i>		
	Ø15	15	<b>4.25</b> 0620106
	Ø22	10	<b>5.45</b> 0620107
Ø28	8	<b>9.70</b> 0620108	
	<b>7759</b> <i>Sistēmas uzpildes ventilis</i>		
	1/2"		<b>8.93</b> 0620109
	<i>Lodveida ventilis ar atgaisotāju</i>		
	1/2"	10	<b>9.83</b> 0620042
	3/4"	10	<b>4.60</b> 0620043
	1,1/4"		<b>9.75</b> 0620045
	1,1/2"		<b>13.40</b> 0620046
2"		<b>17.00</b> 0620047	
	<b>7620</b> <i>Lodveida trīscēļu ventilis</i>		
	1/2"		<b>15.20</b> 0620032
	3/4"		<b>18.80</b> 0620033
	1,1/4"		<b>37.60</b> 0620035
	1,1/2"		<b>67.20</b> 0620036
2"		<b>102.00</b> 0620037	
	<b>7300</b> <i>Dārza krāns</i>		
	1/2"	12	<b>7.49</b> 0620021
	3/4"	10	<b>10.37</b> 0620022
	1"	6	<b>17.13</b> 0620023
	<b>7350</b> <i>Dārza krāns</i>		
	1/2"	20	<b>7.48</b> 0620024
	3/4"	10	<b>10.39</b> 0620025
	1"	6	<b>18.91</b> 0620061
	<b>7700</b> <i>Mini ventilis</i>		
	1/2"	20	<b>4.98</b> 0620011
	<b>7720</b> <i>Mini ventilis</i>		
	1/2"	25	<b>4.92</b> 0620012
	<b>5230</b> <i>Aizbīdnis</i>		
	1/2"	20	<b>7.75</b> 0620062
	3/4"	20	<b>8.73</b> 0620063
	1"	20	<b>12.63</b> 0620064
	1,1/4"	10	<b>19.54</b> 0620119
	1,1/2"	10	<b>25.08</b> 0620120
	2"		<b>37.87</b> 0620121
	2,1/2"		<b>18.20</b> 0620122
3"		<b>24.30</b> 0620123	
	<i>Lodveida ventilis iebūvei sienā</i>		
	<b>8002</b>		
	1/2"	8	<b>17.54</b> 0620065
3/4"		<b>20.46</b> 0620066	

## Noslēgarmatūra

		GAB.	EUR	VEIKALS
	<b>1772891</b>	<i>Termostata ventilis aksiālais</i> HERTZ TS-90		
	1/2"		<b>15.01</b>	<b>6320005</b>
	<b>3613</b>	60	<b>13.76</b>	<b>0620086</b>
	<b>3602</b>	<i>Radiatoru ventilis taisnais</i>		
	1/2"	15	<b>7.53</b>	<b>0620080</b>
	<b>3601</b>	<i>Radiatoru ventilis leņķa</i>		
	1/2"	15	<b>6.43</b>	<b>0620078</b>
	<b>3604</b>	<i>Balansa ventilis taisnais</i>		
	1/2"	15	<b>7.36</b>	<b>0620081</b>
	<b>3603</b>	<i>Balansa ventilis leņķa</i>		
	1/2"	15	<b>6.35</b>	<b>0620079</b>
	<b>3630</b>	<i>Drošības vārsts</i>		
	1/2" 3 bar		<b>7.35</b>	<b>0620087</b>
	3/4" 3 bar		<b>20.75</b>	<b>0620088</b>
	<b>3631</b>	<i>Drošības vārsts</i>		
	1/2" 6 bar		<b>7.81</b>	<b>0620143</b>
	3/4" 6 bar		<b>12.58</b>	<b>0620144</b>
	<b>4005</b>	<i>Drošības grupa ar manometru</i>		
	6 bar		<b>50.33</b>	<b>1720007</b>
	<b>4000</b>	<i>Drošības grupa ar manometru</i>		
	3 bar		<b>45.56</b>	<b>1720006</b>
	<b>4021</b>	<i>Atgaisotais automātiskais taisnais</i>		
			<b>6.91</b>	<b>1720004</b>
	<b>0200.293</b>	<i>Atgaisotais automātiskais, leņķa</i>		
			<b>6.89</b>	<b>1720005</b>
	<b>3620</b>	<i>Atgaisotais automātiskais taisnais</i>		
	1/2"	16	<b>7.33</b>	<b>0620082</b>
	<b>7009C</b>	<i>Atgaisotais automatiskais leņķa</i>		
	1/2"	10	<b>12.24</b>	<b>0920002</b>
	<b>3621</b>	<i>Atgaisotāja pretvārsts</i>		
	1/2"		<b>0.59</b>	<b>0620092</b>

		GAB.	EUR	VEIKALS
	<b>9003</b>	<i>Atgaisotājs mehāniskais</i>		
	1/2"		<b>1.94</b>	<b>7420004</b>
	<b>9825 O</b>	<i>Atgaisotājs mehāniskais</i>		
	1/2"	25	<b>1.29</b>	<b>1720002</b>
	<b>9825 balts</b>	<i>Korķis ar blīvi hromēts</i>		
	1/2"	25	<b>0.95</b>	<b>7420005</b>
	<b>9825 Z</b>	<i>Korķis ar blīvi hromēts</i>		
	1/2"	25	<b>1.11</b>	<b>1720003</b>
	<b>9824 met</b>	<i>Atslēga radiatora atgaisošanai (metāla)</i>		
			<b>1.09</b>	<b>1735011</b>
	<b>9824PL</b>	<i>Atslēga radiatora atg. (plastmasa)</i>		
			<b>0.35</b>	<b>1735006</b>
	<b>2500</b>	<i>Gružu filtrs</i>		
	1/2"	150	<b>5.80</b>	<b>0620093</b>
	3/4"	150	<b>8.10</b>	<b>0620070</b>
	1"	50	<b>12.05</b>	<b>0620071</b>
	1,1/4"	50	<b>22.43</b>	<b>0620072</b>
	1,1/2"	35	<b>27.08</b>	<b>0620073</b>
	2"	35	<b>43.42</b>	<b>0620074</b>
	1/2"	18	<b>3.71</b>	<b>2120033</b>
	<b>1010</b>	<i>Pretvārsts bez sieta</i>		
	1/2"	25	<b>5.71</b>	<b>0620014</b>
	3/4"	20	<b>7.41</b>	<b>0620015</b>
	1"	12	<b>10.08</b>	<b>0620016</b>
	1,1/4"	5	<b>14.25</b>	<b>0620075</b>
	1,1/2"	5	<b>18.50</b>	<b>0620076</b>
	2"	3	<b>27.84</b>	<b>0620077</b>
	2,1/2"		<b>18.20</b>	<b>0620116</b>
	3"		<b>25.50</b>	<b>0620117</b>
	4"		<b>38.90</b>	<b>0620118</b>
	<b>1011</b>	<i>Pretvārsts bez sieta (misīņa disks)</i>		
	1/2"	10	<b>7.87</b>	<b>0620031</b>
	3/4"	8	<b>10.70</b>	<b>0620137</b>
	1"	6	<b>14.62</b>	<b>0620138</b>
	<b>1030</b>	<i>Pretvārsts ar sietu</i>		
	1/2"	25	<b>5.88</b>	<b>0620017</b>
	3/4"	15	<b>6.50</b>	<b>0620018</b>
	1"	12	<b>8.18</b>	<b>0620019</b>
	1,1/4"	6	<b>11.94</b>	<b>0620125</b>
	1,1/2"	4	<b>15.29</b>	<b>0620126</b>
	2"	2	<b>21.24</b>	<b>0620127</b>
	<b>1920</b>	<i>Siets pretvārstam</i>		
	1/2"		<b>1.45</b>	<b>0620067</b>
	3/4"		<b>1.51</b>	<b>0620068</b>
	1"		<b>1.80</b>	<b>0620069</b>
	1,1/4"		<b>2.58</b>	<b>2320108</b>
	1,1/2"		<b>3.97</b>	<b>2320106</b>
	2"		<b>4.59</b>	<b>2320107</b>
	<b>7000</b>	<i>Pretvārsts ar klapi</i>		
	1/2"		<b>7.82</b>	<b>0620110</b>
	3/4"		<b>10.82</b>	<b>0620111</b>
	1"		<b>14.25</b>	<b>0620112</b>
	1,1/4"		<b>20.11</b>	<b>0620113</b>
	1,1/2"		<b>26.65</b>	<b>0620114</b>
	2"		<b>40.45</b>	<b>0620115</b>

		GAB.	EUR	VEIKALS			GAB.	EUR	VEIKALS
	<b>359</b> 1/2"x3/4"x1/2"	10	<b>8.64</b>	<b>2020008</b>	<i>Trīsceļu krāns</i> <i>Stūra ventilis</i>				
	<b>678</b> 3/4"	5	<b>13.51</b>	<b>0120001</b>	<i>Krāns ar pagarinošo daļu</i> <i>Stūra ventilis</i>				
	<b>2242/A</b> 1/2"x3/4"	15	<b>6.52</b>	<b>2020005</b>	<i>Krāns veļas mašīnai</i> <i>Stūra ventilis</i>				
	<b>7830</b> 1/2"x3/4"		<b>7.06</b>	<b>0620013</b>	<i>Krāns veļas mašīnai</i> <i>Stūra ventilis</i>				
	<b>244-030-00</b> 1/2"x3/8"		<b>6.89</b>	<b>0720003</b>	<i>Stūra ventilis</i> <i>Stūra lodveida ventilis</i>				
	<b>7671/IB</b> 1/2"x1/2"		<b>5.35</b>	<b>0620139</b>	<i>Stūra lodveida ventilis</i> <i>Stūra krāns veļas mašīnai</i>				
	<b>950/C</b> 1/2"x1/2"	20	<b>6.42</b>	<b>2020004</b>	<i>Stūra lodveida ventilis ar filtru</i> <i>Stūra krāns veļas mašīnai</i>				
	<b>130400</b> 1/2"x1/2"x3/4"	10	<b>4.43</b>	<b>7420001</b>	<i>Krāns veļas mašīnai</i> <i>Stūra krāns veļas mašīnai</i>				
	<b>694</b> 1/2"x1/2"	2	<b>5.82</b>	<b>0120006</b>	<i>Stūra ventilis</i> <i>Stūra krāns veļas mašīnai</i>				
	<b>4080</b> 1/2"x3/4"		<b>5.35</b>	<b>0620020</b>	<i>Krāns veļas mašīnai</i> <i>Stūra krāns veļas mašīnai</i>				
	<b>FS-01</b> 1/2"x1/2"	SARKANS	<b>5.12</b>	<b>4920008</b>	<i>Stūra ventilis</i>				
		ZILS	<b>5.12</b>	<b>4920009</b>					
	<b>FS-02</b> 1/2"x3/4"		<b>5.24</b>	<b>4920010</b>	<i>Stūra ventilis</i>				
	<b>FS-03</b> 1/2"x1/2"	SARKANS	<b>4.72</b>	<b>4920011</b>	<i>Stūra ventilis</i>				
		ZILS	<b>4.72</b>	<b>4920012</b>					
	<b>FS-04</b> 1/2"x3/4"		<b>4.86</b>	<b>4920013</b>	<i>Stūra ventilis</i>				
	<b>FS-05</b> 1/2"x3/8"x10	SARKANS	<b>5.69</b>	<b>4920014</b>	<i>Stūra ventilis</i>				
	1/2"x3/8"x10	ZILS	<b>5.69</b>	<b>4920015</b>					
	<b>FS-06</b> 1/2"x3/8"x10	SARKANS	<b>5.30</b>	<b>4920016</b>	<i>Stūra ventilis</i>				
	1/2"x3/8"x10	ZILS	<b>5.30</b>	<b>4920017</b>					
	<b>682</b> 1/2"x3/4"	5	<b>7.99</b>	<b>0120024</b>	<i>Krāns veļas mašīnai</i>				
	<b>950/D</b> 1/2"x3/8"x3/4"	6	<b>11.75</b>	<b>2020009</b>	<i>Stūra krāns veļas mašīnai</i>				
	<b>968</b> 1/2"		<b>12.02</b>	<b>0601001</b>	<i>Misiņa krāns vienam ūdenim</i>				
	<b>696</b> 1/2" 3/4"		<b>4.65</b> <b>10.21</b>	<b>0620091</b> <b>0620085</b>	<i>Drošības vārsts boilerim</i>				
	<b>3635</b> 1/2" 3/4"		<b>5.57</b> <b>11.46</b>	<b>0620083</b> <b>0620084</b>	<i>Drošības vārsts boilerim ar rokturi</i>				
	<b>700</b> ø43mm	25	<b>6.83</b>	<b>1245004</b>	<i>Dekoratīvs noslēgs izlietnei hromēts</i>				
	<b>700/10</b> ø43mm	10	<b>7.98</b>	<b>1245019</b>	<i>Dekoratīvs noslēgs izlietnei balts</i>				

		GAB. EUR VEIKALS						GAB. EUR VEIKALS			
<b>SLD1001</b>		<i>Lodveida ventīlis (I-I)</i>									
	1/2"	24/120	<b>3.13</b>	9620003							
	3/4"	18/90	<b>4.92</b>	9620018							
	1"	10/50	<b>6.71</b>	9620019							
	1,1/4"	8/32	<b>10.69</b>	9620020							
	1,1/2"	6/24	<b>16.88</b>	9620021							
	2"	4/12	<b>22.47</b>	9620022							
<b>SLD1002</b>		<i>Lodveida ventīlis (I-I)</i>									
	1/2"	35/175	<b>3.12</b>	9620007							
	3/4"	18/90	<b>4.91</b>	9620034							
	1"	10/50	<b>6.56</b>	9620035							
<b>SLD1003</b>		<i>Lodveida ventīlis (I-Ā)</i>									
	1/2"	24/120	<b>3.69</b>	9620008							
	3/4"	18/90	<b>4.63</b>	9620032							
	1"	10/50	<b>9.06</b>	9620033							
	1,1/4"	8/32	<b>10.36</b>	9620015							
	1,1/2"	6/24	<b>20.88</b>	9620016							
	2"	3/12	<b>31.71</b>	9620017							
<b>SLD1004</b>		<i>Lodveida ventīlis (I-Ā)</i>									
	1/2"	35/175	<b>3.12</b>	9620001							
	3/4"	18/90	<b>4.65</b>	9620013							
	1"	10/50	<b>7.13</b>	9620014							
<b>SLD1016</b>		<i>Lodveida ventīlis ar pieslēguzgriezni</i>									
	1/2"	20/100	<b>5.41</b>	9620002							
	3/4"	14/70	<b>9.46</b>	9620023							
	1"	8/40	<b>12.98</b>	9620044							
	1,1/4"	8/32	<b>8.23</b>	9620004							
<b>SLD1018</b>		<i>Lodveida ventīlis (Ā-Ā)</i>									
	1/2"	35/175	<b>4.00</b>	9620041							
	3/4"	18/90	<b>6.47</b>	9620042							
	1"	10/50	<b>6.74</b>	9620043							
<b>SLD1017</b>		<i>Lodveida ventīlis (Ā-Ā)</i>									
	1/2"	24/120	<b>3.90</b>	9620045							
	3/4"	18/90	<b>6.75</b>	9620046							
	1"	10/50	<b>8.67</b>	9620047							
<b>SLD204</b>		<i>Dārza krāns</i>									
	1/2"	15/60	<b>4.51</b>	9620025							
	3/4"	10/40	<b>5.83</b>	9620026							
	1"	6/24	<b>3.60</b>	9620027							
<b>SLD204</b>		<i>Dārza krāns ar tvertnes vāciņu</i>									
	1/2"		<b>6.04</b>	9620009							
	3/4"		<b>6.53</b>	9620010							
	1"		<b>7.19</b>	9620012							
<b>1010 F</b>		<i>Pretvārsts bez sieta</i>									
	1/2"	30	<b>4.30</b>	2120001							
	3/4"	15	<b>5.69</b>	2120002							
	1"	12	<b>8.03</b>	2120003							
<b>1011 F</b>		<i>Pretvārsts bez sieta (misiņa disks)</i>									
	1/2"		<b>5.58</b>	2120013							
	3/4"		<b>7.91</b>	2120014							
	1"		<b>11.02</b>	2120015							
	1,1/4"		<b>17.31</b>	2120016							
	1,1/2"		<b>22.42</b>	2120017							
	2"		<b>34.45</b>	2120018							
<b>1030 F</b>		<i>Pretvārsts ar sietu</i>									
	1/2"	36	<b>4.22</b>	2120004							
	3/4"	18	<b>4.80</b>	2120005							
	1"	14	<b>5.87</b>	2120006							
	1,1/4"	8	<b>8.89</b>	2120007							
<b>2500/P F</b>		<i>Gružu filtrs ar ausi plombēšanai</i>									
	1/2"	12	<b>3.63</b>	2120033							
	3/4"		<b>8.46</b>	2120008							
	1"		<b>10.82</b>	2120009							
	1,1/4"		<b>20.77</b>	2120010							
	1,1/2"		<b>22.62</b>	2120011							
	2"		<b>33.99</b>	2120012							
<b>Korķu komplekts alumīnija radiatoriem</b>											
		PF RK 552									
		1/2"Fx1"M				<b>5.55</b>		2120031			
		PF RK 553									
		3/4"Fx1"M				<b>7.25</b>		2120032			
<b>KAS01</b>		<i>Komplekts taisnais</i>									
		1/2"				<b>16.11</b>		3920028			
<b>KAS02</b>		<i>Komplekts leņķa</i>									
		1/2"				<b>15.51</b>		3920029			

Modelis	Apraksts	Izmērs	KV2 m³/h	Artikuls	gab./ iep.	VEIKALS EUR
---------	----------	--------	-------------	----------	---------------	-------------

## TERMOVĀRSTI

## Termostata vārsti HERZ-TS-90 (divcauruļu sistēmām)

	<b>HERZ-TS-90, taisns</b> Pieslēgšana radiatoram ar konusa blīvslēgu. Universāls modelis ar pieslēgšanu vītņotajai caurulei vai kompresijas savienojumam.	1/2	1.0	1 7723 91	20	14.26
		3/4	1.9	1 7723 92	20	21.71
	<b>HERZ-TS-90, leņķa</b> Pieslēgšana radiatoram ar konusa blīvslēgu. Universāls modelis ar pieslēgšanu vītņotajai caurulei vai kompresijas savienojumam.	1/2	1.0	1 7724 91	20	14.26
		3/4	1.9	1 7724 92	20	21.71
	<b>HERZ-TS-90, aksiāls</b> Pieslēgšana radiatoram ar konusa blīvslēgu. Universāls modelis ar pieslēgšanu vītņotajai caurulei vai kompresijas savienojumam.	1/2	1.0	1 7728 91	20	15.01
	<b>HERZ-TS-90, taisns</b> Pieslēgšana radiatoram ar konusa saskrūvi. Pieslēgšana ar kompresijas savienojumu vītne G3/4 ar konusu.	1/2	1.0	1 7733 81	20	14.26
	<b>HERZ-TS-90, leņķa</b> Pieslēgšana radiatoram ar konusa saskrūvi. Pieslēgšana ar kompresijas savienojumu vītne G3/4 ar konusu.	1/2	1.0	1 7724 37	20	14.26
	<b>HERZ-TS-90-Termostata vārsts, aksiāls, ārējā vītne</b> Pieslēgšana radiatoram ar konusa saskrūvi. Pieslēgšana ar kompresijas savienojumu vītne G3/4.	1/2	1.0	1 7748 91	20	16.95

## Termostata komplekti

	<b>HERZ-Termostata komplekts, taisns</b> Komplektā: termostata vārsts 1 7723 91 un termostata vārsta galva 1 7260 06	1/2	1.0	1 7723 60		22.25
	<b>HERZ-Termostata komplekts, leņķa</b> Komplektā: termostata vārsts 1 7724 91 un termostata vārsta galva 1 7260 06	1/2	1.0	1 7724 60		22.25
	<b>HERZ-Termostata komplekts, aksiāls</b> Komplektā: termostata vārsts 1 7728 91 un termostata vārsta galva 1 7260 06	1/2	1.0	1 7728 60		22.86

## Termostata vārsti HERZ-TS-E ar maksimālu caurplūdi, jebkurām viencauruļu sistēmām, tai skaitā pašteces, un sistēmām ar lielu patēriņu

	<b>HERZ-TS-E, taisns</b> Pieslēgšana radiatoram ar eirokonusa blīvslēgu. Standarta modelis ar vītņotu muffi.	1/2	1.5 / 5.1	1 7723 11	20	18.41
		3/4	1.5 / 5.1	1 7723 02	20	21.71
		1	1.5 / 5.1	1 7723 03	10	33.09

## Termostata trīsceļu vārsti CALIS-TS

	<b>Termostata trīsceļu vārsts CALIS-TS</b> Pieslēgšana sistēmai ar plakano blīvslēgu. Pieslēguma veidgabali pasūtāmi atsevišķi.	1/2	2.75	1 7761 01	10	23.72
		3/4	3.2	1 7761 02	10	23.72

## Termostata trīsceļu vārsti CALIS-TS 3-asu 3D izpildījumā (termostata galva horizontālā novietojumā)

	<b>Termostata trīsceļu vārsts CALIS-TS-3D</b> Vārsts pa kreisi no radiatora. Pieslēgšana sistēmai ar plakano blīvslēgu. Pieslēguma veidgabali pasūtāmi atsevišķi.	1/2	3.5	1 7761 43	10	29.44
		3/4	4.2	1 7761 45	10	30.29
	<b>Termostata trīsceļu vārsts CALIS-TS-3D</b> Vārsts pa labi no radiatora. Pieslēgšana sistēmai ar plakano blīvslēgu. Pieslēguma veidgabali pasūtāmi atsevišķi.	1/2	3.5	1 7761 44	10	29.44
		3/4	4.2	1 7761 46	10	30.29







Modelis	Apraksts	Izmērs	KV2 m³/h	Artikuls	gab. iep.	VEIKALS EUR
<b>TERMOSTATA VĀRSTU GALVAS</b>						
<b>Termostata vārstu galva HERZ ar vītņi M28x1.5, savietojamas ar HERZ vārstiem</b>						
	<b>Termostata vārsta galva</b> Ar šķidrums sensoru (Hydrosensor), ar pretaižsalšanas 6°C iestatījumu. Iestatāmā temperatūra 6–28°C. Regulēšanas ierobežošana un bloķēšana ar 1 9551 00 (pasūtāms atsevišķi).			1 7260 06	20	12.03
<b>Termostata vārstu galva HERZ "DESIGN MINI", ar vītņi M28x1.5, savietojamas ar HERZ vārstiem</b>						
	<b>Samazinātas formas termostata vārsta galva</b> Ar šķidrums sensoru (Hydrosensor), Regulēšanas diapazons 6–30 °C, ar noslēgšanas "0" un pretaižsalšanas 6 °C iestatījumiem. Ierobežošana un bloķēšana ar 1 9551 02 (pasūtāms atsevišķi). Izmēri: Garums 75 mm, diametrs 45 mm.			1 9200 30	20	13.84
<b>Termostata vārstu galva "HERZCULES", ar vītņi M28x1.5, savietojamas ar HERZ vārstiem</b>						
	<b>Termostata vārsta galva, īpaši stipras konstrukcijas. Vandālisma, zādzības un nepareizas ekspluatācijas droša.</b> Ar šķidrums sensoru (Hydrosensor), Ieregulējams temperatūras režīms 8–26°C, ar automātisku pretaižsalšanu. Montāža un demontāža tikai ar instrumentiem 1 9554 01 un atslēgu 1 6616 00 (iespējams pasūtīt atsevišķi). Temperatūras režīma iestatīšana ar instrumentu 1 9554 00 (komplektā). Noregulētais regulējums bloķēts. Ieregulējums nobloķētā stāvoklī neredzams.			1 9860 10	20	31.63
<b>Termostata vārstu galva ar uzliekamu kapilāru, ar vītņi M28x1.5, savietojamas ar HERZ vārstiem</b>						
	<b>Termostata vārstu galva ar uzliekamu kapilāru silto grīdu sistēmām</b> Termostata galva ar kapilāru, kapilāra cauruli, stiprinājumu pie caurules. Regulēšanas diapazons 20–50°C, kapilāra caurulītes garums 2000mm.			1 7420 06	10	35.32
<b>Iegremdējama čaula</b>						
	<b>Iegremdējama čaula, misiņa</b> priekš 7420/7421, 9421, ar ārēju 1/2" vītņi.			1 6313 01	20	6.76
<b>Termostata vārstu galva HERZ - DESIGN ar iznestu devēju, ar vītņi M28x1.5, savietojamas ar HERZ vārstiem</b>						
	<b>Termostata vārsta galva ar iznestu devēju</b> Termostats ar šķidrums sensoru (Hydrosensor), kapilāra caurulīte un kapilārs. Temperatūras regulēšanas diapazons 6–30°C, ar noslēgšanas "0" un pretaižsalšanas 6°C iestatījumiem. Ierobežošana un bloķēšana ar 1 9551 00 (pasūtāms atsevišķi). Kapilāra caurules garums 2000 mm.			1 9430 08	10	37.41
<b>Termostata vārstu galva HERZ-H, ar vītņi M 30x1.5, radiatoriem ar iebūvētu vārstu ("Heimeier" un citi)</b>						
	<b>Termostata vārsta galva HERZ "H"</b> Iestatāmā temperatūra 6–28°C, nav mehāniski slēdzama, automātiska pretaižsalšanas temperatūra 6°C. Regulēšanas ierobežošana un bloķēšana ar 1 9551 00 (pasūtāms atsevišķi).			1 7260 98	20	12.03
<b>Termostata vārstu galva "HERZCULES-H", ar vītņi M30x1.5, savietojamas ar HERZ vārstiem</b>						
	<b>Termostata vārsta galva, īpaši stipras konstrukcijas. Vandālisma, zādzības un nepareizas ekspluatācijas droša.</b> Ar šķidrums sensoru (Hydrosensor), Ieregulējams temperatūras režīms 8–26°C, ar automātisku pretaižsalšanu. Montāža un demontāža tikai ar instrumentiem 1 9554 01 un atslēgu 1 6616 00 (iespējams pasūtīt atsevišķi). Temperatūras režīma iestatīšana ar instrumentu 1 9554 00 (komplektā). Noregulētais regulējums bloķēts. Ieregulējums nobloķētā stāvoklī neredzams.			1 9860 98	20	31.63
<b>Termostata vārstu galva HERZ "DESIGN MINI-H", ar vītņi M30x1.5, savietojamas ar HERZ vārstiem</b>						
	<b>Samazinātas formas termostata vārsta galva GS</b> Ar šķidrums sensoru (Hydrosensor), regulēšanas diapazons 6–30°C, ar noslēgšanas "0" un pretaižsalšanas 6°C iestatījumiem. Ierobežošana un bloķēšana ar 1 9551 02 (pasūtāms atsevišķi).			1 9200 83	20	13.84
<b>Termostata vārstu galva HERZ DESIGN "D" "Danfoss" vārstiem</b>						
	<b>Termostata vārstu galva HERZ "D"</b> Ar šķidrums sensoru (Hydrosensor), regulējamās temperatūras diapazons 6–28°C, nav mehāniski noslēdzama, automātisks pretaižsalšanas 6°C iestatījums. Temperatūras regulējuma ierobežošana un bloķēšana iespējama.			1 7260 99	20	12.03
<b>Termonešēja temperatūras ierobežotājs-regulators HERZ-"MINI"</b>						
	<b>Atpakaļgaitas temperatūras regulēšanas galva, 25-60°C HERZ-MINI</b> Regulē atpakaļgaitas temperatūru robežās 25-60° C, ierobežošana un bloķēšana ar 1 9551 02 (pasūtāms atsevišķi). Savietojama ar HERZ termostata vārstiem.			1 9201 00	10	23.21





Modelis	Apraksts	Izmērs	KV2 m³/h	Artikuls	gab./ iep.	VEIKALS EUR
---------	----------	--------	-------------	----------	---------------	-------------

### ATPAKAĻGAITAS NOSLĒGVĀRSTI

#### Atpakaļgaitas noslēgvārsti HERZ-RL-5, ar iepēju balansēt un iztukšot sistēmu

	<b>HERZ-RL-5, taisns</b> Priekšiestatīšana, uzpilde un izlaišana. Pievienošana radiatoram ar konisku blīvslēgu. Universālais modelis vītņotajai caurulei vai kompresijas savienojumam.	1/2		1 3923 01	20	10.35
		3/4		1 3923 02	20	14.26
	<b>HERZ-RL-5, leņķa</b> Priekšiestatīšana, uzpilde un izlaišana. Pievienošana radiatoram ar konisku blīvslēgu. Universālais modelis vītņotajai caurulei vai kompresijas savienojumam.	1/2		1 3924 01	20	10.35
		3/4		1 3924 02	20	14.26
	<b>HERZ-RL-5, taisns, ārējā vītne</b> Pieslēgšana radiatoram ar eirokonusa saskrūvi. Pieslēgšana sistēmai ar kompresijas savienojumu ārējā vītne G3/4 ar eirokonusu.	1/2		1 3937 11	20	10.50
	<b>HERZ-RL-5, leņķa, ārējā vītne</b> Pieslēgšana radiatoram ar eirokonusa saskrūvi. Pieslēgšana sistēmai ar kompresijas savienojumu ārējā vītne G3/4 ar eirokonusu.	1/2		1 3948 11	20	10.35

#### Atpakaļgaitas noslēgvārsti HERZ-RL-1

	<b>HERZ-RL-1, taisns</b> Pievienošana radiatoram ar konisku blīvslēgu. Universālais modelis vītņotajai caurulei vai kompresijas savienojumam.	1/2		1 3723 41	20	8.08
		3/4		1 3723 42	20	10.86
	<b>HERZ-RL-1, leņķa</b> Pievienošana radiatoram ar konisku blīvslēgu. Universālais modelis vītņotajai caurulei vai kompresijas savienojumam.	1/2		1 3724 41	20	8.08
		3/4		1 3724 42	20	10.86
	<b>HERZ-RL-1, taisns, ārējā vītne</b> Pieslēgšana radiatoram ar eirokonusa saskrūvi. Pieslēgšana sistēmai ar kompresijas savienojumu ārējā vītne G3/4 ar eirokonusu.	1/2		1 3733 11	20	9.37
	<b>HERZ-RL-1, leņķa, ārējā vītne</b> Pieslēgšana radiatoram ar eirokonusa saskrūvi. Pieslēgšana sistēmai ar kompresijas savienojumu ārējā vītne G3/4 ar eirokonusu.	1/2		1 3748 01	20	9.37

#### Atpakaļgaitas noslēgvārsti HERZ RL-1-E ar palielinātu caurplūdi

	<b>HERZ-RL-1-E, taisns</b> Pieslēgšana radiatoram ar eirokonusa blīvslēgu. Standarta modelis ar vītņotu muffi.	1/2		1 3723 01	20	23.23
		3/4		1 3723 02	20	26.16
		1		1 3723 03	10	51.65

### KOMPRESIJAS SAVIENOJUMI

#### Eirokonuss pievienojuma veidgabali daudzslāņu un polimēra caurulēm, PE-X, PB-, PE- un daudzslāņu caurulēm

	<b>Kompresijas savienojums plastmasas un daudzslāņu caurulei</b> Blīvējumam izmantoti gumijas gredzeni un kompresijas gredzens. Sastāv no nipeļa, kompresijas gredzena, un gredzena ar vītņi G3/4 eirokonusam.	G 3/4	16x2	1 6098 03	10	3.46
		G 3/4	20x2	1 6098 08	10	3.46

#### Eirokonuss pievienojuma veidgabali dzelzs un kapara caurulēm

	<b>Pieslēguma veidgabals ar elastīgu blīvējumu</b> Kompresijas gredzens, masīvs gumijas blīvējums (EPDM) un vītņots gredzens ar vītņi G 3/4. Īpaši ieteicams lietot hromētām dzelzs un leģētā tērauda caurulēm.	G 3/4	15	1 6276 15	10	2.96
---	--	-------	----	-----------	----	------

#### Pievienojuma veidgabali dzelzs un kapara caurulēm

	<b>Pieslēguma veidgabals ar metāla blīvgredzenu.</b> Metāla kompresijas ieliekams gredzens un stiprinājuma nipelis ar konusu.	1/2x15		1 6292 01	10	1.59
---	--	--------	--	-----------	----	------

Modelis	Apraksts	Izmērs	KV2 m³/h	Artikuls	gab. iep.	VEIKALS EUR
---------	----------	--------	-------------	----------	--------------	-------------

### DVIEĻU ŽĀVĒTĀJU PIEVIENOJUMI

#### Leņķa termovārsts divieļu žāvētāja pieslēgšanai VUA-50

	<b>HERZ-VUA-50-leņķa-2-cauruļu sistēma-Design-nalasāma priekšiestatīšana</b> 4-ceļu leņķa vārsts 2-cauruļu sistēmām, ar priekšiestatīšanu, ar plūsmas cauruli L-290mm, D-11mm, bez pārplūdes, ar hromētu pārklājumu, termogalvas pievienojuma vītne-M28x1.5, cauruļu starpcentru attālums-50mm, pievienojuma vītne-M22x1.5	hromēts		<b>S 7684 41</b>	1	<b>65.64</b>
		balts		<b>S 7684 44</b>	1	<b>63.40</b>

#### Termostata vārstu galva

	<b>Termostatiska galva MINI-GS-Design (hromēta)</b> Ar šķidrums sensoru (Hydrosensor), ar noslēgšanas pozīciju "0" un pretaižsaišanas pozīciju 6°C. Temperatūras regulēšana un bloķēšana diapazonā 6–30°C. M28x1.5			<b>S 9200 31</b>	1	<b>29.37</b>
---	--	--	--	------------------	---	--------------

#### Pieslēguma komplekts – M22x1.5

	<b>Pieslēguma komplekts-Design-M22x1.5 (hromēts)</b> Ar gumijas blīvgredzenu no cauruļu stiprinājuma puses, uzgrieznis M22x1.5 Hromēts uzgrieznis	15		<b>S 6286 15</b>	10	<b>10.75</b>
---	---	----	--	------------------	----	--------------

	<b>Pieslēguma komplekts-Design-M22x1.5 (hromēts)</b> Priekš PE-X, PB un metālpolimēra caurulēm. Kompresijas gredzena uzgrieznis M22x1.5. Hromēts uzgrieznis	16x2		<b>S 6066 16</b>	10	<b>12.19</b>
---	--	------	--	------------------	----	--------------

	<b>HERZ Radiatora termoregulatoru komplekts 1/2", taisns</b> 1762367+1726006+1372341	1/2"		<b>V772301</b>	10	<b>26.13</b>
---	---	------	--	----------------	----	--------------







	<b>HERZ Radiatora termoregulatoru komplekts 1/2", leņķa.</b> 1762467+1726006+1372441	1/2"		<b>V772401</b>	10	<b>26.13</b>
---	---	------	--	----------------	----	--------------

	<b>HERZ Radiatora termoregulatoru komplekts 1/2", aksiālais.</b> 1772891+1726006+1372441	1/2"		<b>V772891</b>	10	<b>26.13</b>
---	---	------	--	----------------	----	--------------

	<b>HERZ stūra ventīlis 1/2"-1/2"</b>	1/2"		<b>1255101</b>		<b>4.18</b>
---	--------------------------------------	------	--	----------------	--	-------------

	<b>HERZ stūra ventīlis 1/2"-3/8" un 3/4"</b>	1/2"		<b>1255201</b>		<b>5.74</b>
---	--	------	--	----------------	--	-------------







Modelis	Apraksts	Izmērs	KV2 m <sup>3</sup> /h	Artikuls	gab./ iep.	VEIKALS EUR
<b>TRĪSCEĻU VĀRSTI</b>						
<b>Termostatisks trīsceļu jaucējvārsts HERZ-TEPLOMIX</b>						
	<b>Termostatisks trīsceļu jaucējvārsts HERZ-TEPLOMIX</b> "Teplomix" 3-ceļu jaucējvārsts ir paredzēts uzstādīšanai katlu apsāistes atpakaļgaitā, temperatūras paaugstināšanai tajā. Rūpnīcas iestatījums sajaukšanas temperatūrai. Ar korķi noslēgts 3/8 pieslēgums tīrīšanai. Maksimālā ekspluatācijas temperatūra 110 °C. Modeļiem 7766 03 un 7766 04 nenoslēdzams "bypass", "bypass" zarā nepieciešams uzstādīt balansējošo vārstu. Temp. atpakaļgaitā 61 °C. Modeļiem 7766 13 un 7766 14 noslēdzams "bypass", temp. atpakaļgaitā 55–63 °C. (maks. novirze 10%). DN 25, Kvs=11; DN 32, Kvs=14	1	11	1 7766 13	1	69.56
		1 1/4	14	1 7766 14	1	71.31
<b>Trīsceļu jaucējvārsts ar rokturi</b>						
	<b>Trīsceļu jaucējvārsts, PN 10</b> Iekšējās vītnes. Korpus un cilindrs no DZR-misiņa. EPDM blīvējums. Temperatūru diapazons -10°C līdz +110°C.	3/4	6.3	1 2137 02	1	32.67
		1	10	1 2137 03	1	
		1 1/4	16	1 2137 04	1	
<b>Trīsceļu jaucējvārsta motors</b>						
	<b>Trīsceļu jaucējvārsta motors HERZ NR 230-455, 230 V</b>			1 7712 63	1	114.13
<b>Pārplūdes vārsti HERZ, spiediena starpības noturēšanai</b>						
	<b>Pārplūdes vārsts spiediena starpības noturēšanai, taisns</b> Korpus no misiņa, niķelēts. Pieslēgšana sistēmai ar plakanā blīvējuma saskrīvi. Pievienojuma veidgabali pasūtāmi atsevišķi.	1/2	10-2000 l/h	1 4004 31	1	26.41
<b>BALANSIERI</b>						
<b>Balansēšanas vārsti HERZ ar mērdiafragmu un mērnipeļiem, slīps Y-veida</b>						
	<b>Balansēšanas vārsts STRÖMAX FODRV, ar mērdiafragmu un mērnipeļiem spiediena starpības mērīšanai, jaunais modelis</b> Izgatavots no cinka izskalošanas noturīga DZR misiņa, iekšējās vītnes mufē x mufē. Vārpstas blīvējums ar dubultu gredzenu (ORing). Priekšiestatīšana ar stieņa gājienu garuma ierobežošanu, Iestatījuma nolaišana roktura displejā. 2 mērnipeļi (1 0284). Mērījuma nolaišanai mērnipeļu pagarinājumi un drenāžas ventīlis pasūtāmi atsevišķi. Pieslēguma veidgabali: DN 15: adapteris 1 6266 01 un kompresijas savienojums G3/4 (pasūtāms atsevišķi). DN 20: adapteris 1 6266 20 un kompresijas savienojums G3/4 (pasūtāms atsevišķi).	1/2	2.00	1 4017 01	10	39.75
		3/4	3.60	1 4017 02	10	44.17
		1	6.50	1 4017 03	10	52.09
		1 1/4	13.30	1 4017 04	5	62.29
<b>Balansēšanas vārsti HERZ, STRÖMAX-GM, patēriņa mērīšanai un regulēšanai, ar iekšējo vītņi, vārpsta taisna</b>						
	<b>Balansēšanas vārsts STRÖMAX-GM, taisns, ar mērnipeļiem</b> Iekšējās vītnes mufē x mufē; Vārpsta blīvēta ar diviem gumijas blīvgredzēniem O-Ring. Priekšiestatīšana ar gājienu ierobežošanu, Iestatījuma nolaišana roktura displejā. 2 mērnipeļi (1 0284) montēti blakus rokturim. DN 15–DN 50: 2 pieslēgumi ar vītņi 1/4" noslēgti ar korķiem 1 0273 09 DN 65–DN 80: 2 pieslēgumi ar vītņi 3/8" noslēgti ar korķiem 1 0273 00. Priekšiestatīšanas plombe 1 6517 04 un zīme 1 6517 05 komplektā. Nolaišanas vārsts 276 pasūtāms atsevišķi. Pieslēguma veidgabali: DN 15: adapteris 1 6266 01 un kompresijas savienojums G3/4 (pasūtāms atsevišķi) DN 20: adapteris 1 6266 20 un kompresijas savienojums G3/4 (pasūtāms atsevišķi)	1/2	6.00	1 4217 01	10	54.99
		3/4	6.88	1 4217 32	10	
		1	13.23	1 4217 33	10	
		1 1/4	18.91	1 4217 34	5	
<b>Balansēšanas vārsti HERZ 4117 patēriņa regulēšanai un spiediena starpības izmērīšanai, ar slīpu vārpstu, Y-veida</b>						
	<b>Balansēšanas vārsts STRÖMAX-M, patēriņa regulēšanai un spiediena starpības mērīšanai, ar slīpu vārpstu un mērnipeļiem</b> Ar iekšējām vītņēm, vārpstas blīvējums ar gumijas blīvgredzēniem, Priekšiestatīšana ar vārpstas gājienu ierobežošanu. Vārsta sēža blīvējas ar gumijas blīvgredzenu. DN 15–DN 20: 2 pievienojumi ar vītņi 1/4 mērnipeļiem (komplektā mērnipeļi), 1 pievienojums ar vītņi 1/4 nolaišanas vārstam HERZ, noslēgts ar korķi. DN 20–DN 50: 2 pievienojumi ar vītņi 1/4 mērnipeļiem (komplektā mērnipeļi), 2 pievienojums ar vītņi 1/4 nolaišanas vārstam HERZ, noslēgts ar korķi. DN 65–DN 80: 2 pievienojumi ar vītņi 1/4 mērnipeļiem (komplektā mērnipeļi), 2 pievienojums ar vītņi 3/8 nolaišanas vārstam HERZ, noslēgts ar korķi. Pieslēguma veidgabali: DN 15: Universālais modelis vītņotas caurules pievienošanai vai kompresijas savienojumiem. DN 20: Adapteris 1 6266 20 un kompresijas savienojums ar vītņi G3/4. Adapteris un kompresijas savienojums pasūtāms atsevišķi.	1/2	4.75	1 4117 51	10	24.36
		3/4	6.12	1 4117 52	10	32.42
		1	10.40	1 4117 53	10	39.62
		1 1/4	15.97	1 4117 54	5	53.53





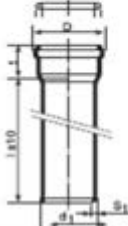

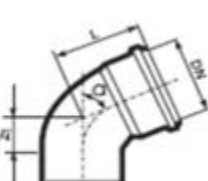





HERZ

Apraksts	Artikuls	Mērv.	VEIKALS
HERZ-LINE PE-RT 16x2mm, sarkana, 240m rullī	HZ162240 (6319029)	m	€ 0.72
HERZ-LINE PE-RT 16x2mm, sarkana, 480m rullī	HZ162480 (6319030)	m	€ 0.72
HERZ-LINE PE-RT 16x2mm, sarkana, 600m rullī	HZ162600 (6319023)	m	€ 0.88
HERZ-LINE PE-RT 20x2mm, sarkana, 240m rullī	HZ202240 (6319024)	m	€ 1.01

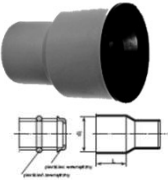

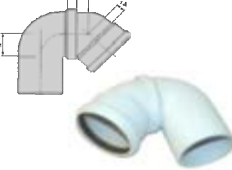

Tehniskais parametrs	16x2.0	17x2.0	20x2.0
Materiāls	PE-RT Polietilēns ar augstu temperatūras noturību	PE-RT Polietilēns ar augstu temperatūras noturību	PE-RT Polietilēns ar augstu temperatūras noturību
Pasūtīšanas apzīmējums	PE-RT 16X2	PE-RT 17X2	PE-RT 20X2
Tips	5-sāņu plastmasas caurule	5-sāņu plastmasas caurule	5-sāņu plastmasas caurule
Ārējais diametrs (mm)	16	17	20
Sieniņas biezums (mm)	2	2	2
Iekšējais diametrs (mm)	12	13	16
Caurules svārs(g./m)	90	100	120
Svārs ar ūdeni (g./m)	203	233	321
Iekšējais tilpums (l/m)	0.113	0.133	0.201
Izplešanās koeficients (mm/mK)	0.19	0.19	0.19
Siltumvadītspēja (W/mK) vidējā	0.35	0.35	0.35
Skābekļa difūzija (mg/lđ)	<0.1	<0.1	<0.1
Maksimālā darba temperatūra (°C)	70	70	70
Maksimālais darba spiediens (bar) pie 70°C	6	6	6
Ārkārtas temperatūras noturība °C	90	90	90
Blīvums (g/cm <sup>3</sup> )	0.933	0.933	0.933
Liekšanas rādiuss *	5 x od	5 x od	5 x od
Krāsa	Sarkana	Sarkana	Sarkana
Metri rullī (m)	240, 480, 600	240	240
Slāņu struktūra	PE-RT Adhezīvs (līme) Skābekļa barjera Adhezīvs (līme) PE-RT	PE-RT Adhezīvs (līme) Skābekļa barjera Adhezīvs (līme) PE-RT	PE-RT Adhezīvs (līme) Skābekļa barjera Adhezīvs (līme) PE-RT
Pielietojums	Silto grīdu un sienas paneļu apsildes sistēmās	Silto grīdu un sienas paneļu apsildes sistēmās	Silto grīdu un sienas paneļu apsildes sistēmās









	VEIKALS	EUR		VEIKALS	EUR	
 	<b>800</b>		<i>Caurule ar uznavu</i>	<b>802</b>		<i>Atzars</i>
	DN 32/250	0.86	6180001	DN 50/32; 45°	1.63	6180041
	DN 32/500	1.01	6180002	DN 50/32; 67°	1.81	6180042
	DN 32/1000	1.66	6180003	DN 50/32; 90°	1.65	6180043
	DN 32/2000	2.94	6180004	DN 50/40; 45°	2.05	6180118
	DN 40/150	0.99	6180111	DN 50/40; 67°	2.11	6180113
	DN 40/250	1.07	6180005	DN 50/40; 90°	2.11	6180119
	DN 40/500	1.17	6180006	DN 50/50; 45°	1.18	6180044
	DN 40/1000	1.76	6180007	DN 50/50; 67°	1.18	6180045
	DN 40/1500	5.00	6180112	DN 50/50; 90°	1.18	6180046
	DN 40/2000	3.84	6180008	DN 75/50; 45°	2.33	6180075
	DN 50/150	1.00	6180110	DN 75/50; 67°	2.32	6180076
	DN 50/250	1.12	6180009	DN 75/50; 90°	2.33	6180077
	DN 50/500	1.21	6180010	DN 75/75; 45°	2.34	6180072
	DN 50/1000	1.94	6180011	DN 75/75; 67°	2.40	6180073
	DN 50/1500	3.07	6180089	DN 75/75; 90°	2.35	6180074
	DN 50/2000	3.45	6180012	DN 110/50; 45°	2.24	6180047
	DN 75/150	1.88	6180116	DN 110/50; 67°	2.19	6180048
	DN 75/250	1.72	6180066	DN 110/50; 90°	2.19	6180049
	DN 75/500	2.35	6180067	DN 110/75; 45°	3.99	6180071
	DN 75/1000	3.60	6180068	DN 110/75; 67°	4.69	6180104
	DN 75/2000	6.64	6180069	DN 110/75; 90°	3.51	6180070
	DN 110/150	2.14	6180109	DN 110/110; 45°	2.96	6180050
	DN 110/250	2.00	6180013	DN 110/110; 67°	2.81	6180051
	DN 110/500	2.94	6180014	DN 110/110; 90°	2.86	6180052
	DN 110/1000	4.72	6180015			
	DN 110/1500	7.62	6180088	<b>803</b>		<i>Redukcija garā</i>
	DN 110/2000	8.31	6180016	DN 40/32 (BALTA)	1.29	6180097
				DN 50/32 (BALTA)	0.85	6180053
				DN 50/40	0.87	6180054
				DN 75/50	1.52	6180085
				DN 110/50	1.15	6180055
			DN 110/75	1.61	6180081	
 	<b>801</b>		<i>Līkums</i>	<b>804</b>		<i>Dubultatzars</i>
	DN 32/15°	0.77	6180017	DN 50/50/50; 45°	3.81	6180096
	DN 32/30°	0.71	6180018	DN 50/50/50; 67°	3.58	6180107
	DN 32/45°	0.71	6180019	DN 50/50/50; 90°	3.53	6180087
	DN 32/67°	0.73	6180020	DN 110/50/50; 45°	10.93	6180100
	DN 32/90°	0.71	6180021	DN 110/50/50; 67°	10.41	6180108
	DN 40/15°	1.12	6180092	DN 110/50/50; 90°	9.99	6180101
	DN 40/30°	0.77	6180091	DN 110/75/75; 67°	8.15	6180121
	DN 40/45°	0.70	6180022	DN 110/110/110; 45°	9.00	6180094
	DN 40/67°	1.12	6180090	DN 110/110/110; 67°	7.98	6180106
	DN 40/90°	0.70	6180023	DN 110/110/110; 90°	7.85	6180095
	DN 50/15°	0.75	6180024			
	DN 50/20°	0.75	6180025			
	DN 50/30°	0.70	6180026			
	DN 50/45°	0.70	6180027			
	DN 50/67°	0.70	6180028			
	DN 50/90°	0.70	6180029			
	DN 75/15°	1.53	6180117			
	DN 75/30°	1.74	6180083			
	DN 75/45°	1.69	6180079			
	DN 75/67°	1.70	6180084			
DN 75/90°	1.60	6180078				
DN 110/15°	1.55	6180030				
DN 110/20°	1.89	6180031				
DN 110/30°	1.60	6180032				
DN 110/45°	1.65	6180033				
DN 110/67°	1.67	6180034				
DN 110/90°	1.84	6180035				
	<b>802</b>		<i>Atzars</i>	<b>805</b>		<i>Stūra dubultatzars</i>
	DN 32/32; 45°	1.32	6180036	DN 110/110/110; 67°	22.36	6180123
	DN 32/32; 67°	1.27	6180037	DN 110/110/110; 90°	14.44	6180105
	DN 32/32; 90°	1.32	6180038			
	DN 40/40; 45°	1.64	6180039			
	DN 40/40; 67°	1.53	6180093			
DN 40/40; 90°	1.58	6180040				
	<b>806</b>		<i>Dubultuzmava ar ierobežotāju</i>			
	DN 40	1.42	6180056			
	DN 50	1.38	6180057			
	DN 75	2.53	6180082			
	DN 110	2.63	6180058			

## IEKŠĒJĀ KANALIZĀCIJA

	<b>807</b>		<i>Revīzija</i>
	DN 50	<b>1.64</b>	<b>6180059</b>
	DN 75	<b>3.53</b>	<b>6180080</b>
	DN 110	<b>3.36</b>	<b>6180060</b>
	<b>808</b>		<i>Slīdmufe</i>
	DN 32	<b>1.07</b>	<b>6180061</b>
	DN 40	<b>1.24</b>	<b>6180062</b>
	DN 50	<b>1.32</b>	<b>6180063</b>
	DN 75	<b>2.77</b>	<b>6180086</b>
	DN 110	<b>2.46</b>	<b>6180064</b>
	<b>809</b>		<i>Kompensators</i>
	DN 40	<b>2.47</b>	<b>6180114</b>
	DN 50	<b>2.58</b>	<b>6180099</b>
	DN 75	<b>3.76</b>	<b>6180124</b>
	DN110	<b>4.14</b>	<b>6180098</b>
	<b>810</b>		<i>Korķis</i>
	DN 32	<b>0.54</b>	<b>6180126</b>
	DN 40	<b>0.62</b>	<b>6180152</b>
	DN 50	<b>0.54</b>	<b>6180134</b>
	DN 75	<b>0.93</b>	<b>6180153</b>
	DN 110	<b>0.86</b>	<b>6180135</b>
	<b>811</b>		<i>Pāreja uz čugunu ar gumiju</i>
	DN 50	<b>2.78</b>	<b>6180136</b>
	DN 75	<b>4.50</b>	<b>6180125</b>
	DN 110	<b>5.17</b>	<b>6180137</b>
	DN 160	<b>8.20</b>	<b>6180145</b>
	<b>812</b>		<i>Gaisa vārsts</i>
	DN 50	<b>3.12</b>	<b>6180132</b>
	DN 75	<b>4.33</b>	<b>6180154</b>
	DN 110	<b>16.99</b>	<b>6180133</b>
	<b>817</b>		<i>Gaisa vārsts Ø50</i>
	50	<b>5.28</b>	<b>6180139</b>
	110	<b>12.49</b>	<b>6180140</b>
	<b>814</b>		<i>Redukcijas līkums</i>
	50/32; 90°	<b>0.75</b>	<b>6180065</b>
	<b>815</b>		<i>Grozāms līkums</i>
	DN 50 (BALT)	<b>1.58</b>	<b>6180127</b>
	DN 100 (BAL)	<b>4.27</b>	<b>6180128</b>
	<b>819</b>		<i>Ventilācijas jumtiņš</i>
	50	<b>3.38</b>	<b>6180141</b>
	110	<b>8.40</b>	<b>6180142</b>
			<i>Kanalizācijas gaisa vārsts</i>
	CEP3240	<b>17.24</b>	<b>6180161</b>
	CEP4050	<b>19.31</b>	<b>6180157</b>
	CEP100	<b>31.20</b>	<b>6180158</b>











	<b>816</b>		<i>Labošanas uzdeva - pāreja</i>
	DN 50	<b>3.19</b>	<b>6180159</b>
	DN 110	<b>4.93</b>	<b>6180150</b>
	<b>803Z</b>		<i>Redukcija zemā</i>
	DN 110/50	<b>1.89</b>	<b>6180115</b>
	DN 110/75	<b>2.23</b>	<b>6180146</b>
	DN 40/32	<b>1.18</b>	<b>6180147</b>
	DN 50/40	<b>1.18</b>	<b>6180148</b>
	DN 75/50	<b>1.34</b>	<b>6180149</b>
	<b>823</b>		<i>Labošanas redukcija</i>
	DN 110/50	<b>3.95</b>	<b>6180151</b>
	<b>FKV00A0</b>		<i>WC pretnopludināšanas vārsts</i>
	DN 110	<b>7.90</b>	<b>6880012</b>
			<i>Univers.pieslēgums kanalizācijai</i>
	COS0A48 DN 110/40	<b>15.50</b>	<b>6850045</b>
	COS0A58 DN 110/50	<b>15.50</b>	<b>6850046</b>
	<b>5000</b>		<i>Kanalizācijas pretvārsts</i>
	Ø50	<b>16.69</b>	<b>6180138</b>
	<b>GEB-GEBEX PLUS</b>		
	400 gr	<b>5.11</b>	<b>6766025</b>
	Uz silikona bāzes veidota formula visu veidu cauruļvadu eļļošanai: plastmasas, čuguna, betona, u.c., kā arī gumijas blīvju aizsardzībai jebkuros laika apstākļos.		
	<b>GEB-GEBEX</b>		
	200 gr	<b>3.62</b>	<b>6766015</b>
	500 gr	<b>5.17</b>	<b>6766016</b>
	Montāžas smēre cauruļvadiem kura nesatur silikonu. Pielieto plastikas cauruļvadu montāžā, uzdevās un gumijas blīvju uzstādīšanā u.c. *Piemērots spiediena un kanalizācijas caurulēm. *Nodrošina vieglu slīdēšanu. *Aizsargā gumijas blīvējumus.		
	<b>813</b>		<i>HT smērviela</i>
	150 gr.	<b>3.23</b>	<b>6866003</b>
	250 gr.	<b>3.76</b>	<b>6866004</b>
	1000 gr	<b>10.25</b>	<b>6866005</b>
			<i>Troše cauruļu tīrīšanai</i>
	150 cm	<b>4.45</b>	<b>7435001</b>
	250 cm	<b>5.84</b>	<b>7435002</b>
	350 cm	<b>7.71</b>	<b>7435003</b>
	500 cm	<b>10.34</b>	<b>7435004</b>
	750 cm	<b>20.79</b>	<b>7435005</b>
	<b>VANTUSS</b>		<i>Vantūzis</i>
		<b>4.15</b>	<b>2935007</b>

	VEIKALS	EUR	
<b>850</b>	<i>Caurule ar uznavu SN4</i>		
	DN 110/500	5.37	5467001
	DN 110/1000	6.37	5467002
	DN 110/2000	11.79	5467003
	DN 110/3000	19.83	5467004
	DN 125/500	5.97	5467008
	DN 125/1000	8.07	5467009
	DN 125/2000	16.36	5467010
	DN 160/500	9.22	5467012
	DN 160/1000	11.43	5467013
	DN 160/2000	21.65	5467014
	DN 160/3000	33.48	5467015
	DN 200/1000	18.09	5467019
	DN 200/2000	34.27	5467020
	DN 200/3000	53.74	5467021
<b>850/8</b>	<i>Caurule ar uznavu SN8, trīsslāņu</i>		
	DN 110/500		5467098
	DN 110/1000		5467024
	DN 110/2000		5467025
	DN 110/3000		5467007
	DN 160/500	7.74	5467099
	DN 160/1000		5467029
	DN 160/2000	20.35	5467030
	DN 160/3000	30.52	5467031
	DN 200/1000		5467034
	DN 200/2000		5467035
	DN 200/3000	47.97	5467036
<b>851</b>	<i>Līkums</i>		
	DN 110/15°	2.13	5467039
	DN 110/30°	2.39	5467040
	DN 110/45°	2.39	5467041
	DN 110/67°	2.69	5467042
	DN 110/87,5°	2.95	5467043
	DN 125/15°	4.06	5467044
	DN 125/30°	2.69	5467045
	DN 125/45°	4.80	5467046
	DN 125/67°	4.34	5467047
	DN 125/87,5°	5.42	5467048
	DN 160/15°	5.18	5467049
	DN 160/30°	4.68	5467050
	DN 160/45°	5.06	5467051
	DN 160/67°	9.08	5467052
	DN 160/87,5°	9.37	5467053
	DN 200/15°	12.99	5467054
	DN 200/30°	12.99	5467055
	DN 200/45°	12.96	5467056
	DN 200/67°	12.71	5467057
	DN 200/87,5°	14.25	5467058
<b>861</b>	<i>Pāreja uz čugunu ar gumiju</i>		
	DN110	9.28	5467101
	DN160	13.98	5467102

	VEIKALS	EUR	
<b>852</b>	<i>Atzars</i>		
	DN 110/110; 45°	5.47	5467059
	DN 110/110; 67°	4.55	5467060
	DN 110/110; 87°	4.26	5467061
	DN 125/110; 45°	6.48	5467062
	DN 125/110; 87°	5.61	5467063
	DN 125/125; 45°	7.67	5467064
	DN 125/125; 87°	8.11	5467065
	DN 160/110; 45°	8.54	5467066
	DN 160/110; 87°	11.12	5467067
	DN 160/125; 45°	11.02	5467068
	DN 160/125; 87°	9.77	5467069
	DN 160/160; 45°	12.95	5467070
	DN 160/160; 87°	12.08	5467071
	DN 200/110; 45°	20.09	5467072
	DN 200/110; 87°	15.16	5467073
	DN 200/125; 45°	16.32	5467074
	DN 200/125; 87°	14.96	5467075
	DN 200/160; 45°	22.03	5467076
	DN 200/160; 87°	20.45	5467077
	DN 200/200; 45°	27.91	5467078
	DN 200/200; 87°	22.94	5467079
<b>853</b>	<i>Redukcija</i>		
	DN 125/110	5.89	5467080
	DN 160/110	3.81	5467081
	DN 160/125	3.95	5467082
	DN 200/160	9.84	5467084
<b>856</b>	<i>Dubultuzmava ar ierobežotāju</i>		
	DN 110	4.62	5467026
	DN 125	3.75	5467106
	DN 160	5.98	5467027
	DN 200	12.64	5467028
<b>858</b>	<i>Slīdmufe</i>		
	DN 110	3.35	5467085
	DN 125	3.89	5467086
	DN 160	5.10	5467087
	DN 200	10.96	5467088
<b>857</b>	<i>Revīzija</i>		
	DN 110	7.22	5467089
	DN 160	13.82	5467090
	DN 200	68.30	5467091
<b>857-VS</b>	<i>Revīzija ar skrūvēm</i>		
	DN 160	22.22	5467096
	DN 200	56.93	5467097
<b>860</b>	<i>Korķis</i>		
	DN 110	1.52	5467092
	DN 160	2.66	5467093
	DN 200	4.79	5467094
<b>5000</b>	<i>Pretvārsts</i>		
	DN 110	44.36	5467103
	DN 160	59.01	5467104
	DN 200	138.93	5467105
<b>866</b>	<i>Labošanas uzmava - pāreja</i>		
	DN 110	5.53	5467100













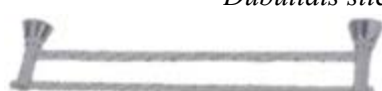



## VANNAS ISTABAS AKSESUĀRI













		EUR				EUR	
	<b>82611C</b>						
	<i>Ziepju trauks</i>	<del>8.20</del>	1131057	97	<b>3.50</b>		
	<b>82624C</b>						
	<i>Stienis dvieļiem (60 cm)</i>	<del>14.93</del>	1131021	97	<b>9.50</b>		
	<b>82624DC</b>						
	<i>Dubultais stienis dvieļiem (60 cm)</i>	<del>24.26</del>	1131022	75	<b>16.00</b>		
	<b>82680C</b>						
	<i>Riņķis dvieļiem</i>	<del>6.80</del>	1131023	38	<b>4.30</b>		
	<b>82684DC</b>						
	<i>Dubulta glāze ar sienas stiprinājumu</i>	<del>14.02</del>	1131026	78	<b>9.30</b>		
	<b>82684C</b>						
	<i>Glāze ar sienas stiprinājumu</i>	<del>8.53</del>	1131025	84	<b>5.50</b>		
	SPL-Y					<i>Lampa Y</i>	
				39	<del>9.73</del>	<b>1.99</b>	9879002
	SPL-D3					<i>Lampa D3</i>	
				2	<del>7.64</del>	<b>1.49</b>	9879003
	SPL-D39					<i>Lampa D39</i>	
				9	<del>13.60</del>	<b>2.99</b>	9879001
		<del>3.37</del>	SPL-D240			<i>Lampas stikla daļas</i>	9879004
		<del>3.37</del>	SPL-D165			<i>Lampas stikla daļas</i>	9879005
	104206262					<i>Āķītis, līmējams</i>	
						<i>Ražotājs Bemeta (Čehija)</i>	
					<b>8.50</b>		8231071

EUR		EUR	
	83724C Stienis dvieļiem (60 cm) <del>12.67</del> 1131046 137 <b>6.30</b>		85011 Ziepjū trauks, metāla <del>17.36</del> 1131069 76 <b>8.50</b>
	83780C BLISTERIS Riņķis dvieļiem <del>5.90</del> 1131049 18 <b>3.50</b>		85024C Stienis dvieļiem (60 cm) <del>21.32</del> 1131070 61 <b>12.00</b>
	83782C Āķītis dubultais 4.34 1131050 151 <b>2.65</b>		85080C Stienis dvieļiem <del>15.61</del> 1131072 65 <b>8.80</b>
	83784C BLISTERIS Glāze ar <del>6.14</del> 1131051 131 <b>3.60</b>		85084C Glāze ar sienas stiprinājumu <del>13.68</del> 1131074 134 <b>6.30</b>
	83781C BLISTERIS Šķidro ziepju trauks ar turētāju un dozatoru <del>9.47</del> 7131010 126 <b>5.30</b>		85084D Dubulta glāze ar sienas stiprinājumu <del>19.16</del> 1131077 17 <b>12.50</b>
	83787C Stikla plaukts <del>12.52</del> 1131048 191 <b>7.50</b>		85085 Ziepjū trauks <del>13.68</del> 1131075 24 <b>8.50</b>
	83786C Tualetes papīra turētājs 1131044 300 <b>7.20</b>		85088 Poda birste ar keramikas trauciņu <del>21.05</del> 1131079 74 <b>11.00</b>

## VANNAS ISTABAS AKSESUĀRI

	VEIKALS EUR		VEIKALS EUR
<b>84211C</b> <i>Ziepju trauks, metāla</i> 	<del>16.26</del>	1131034	<del>8.48</del>
	8	<b>10.20</b>	308
<b>84224C</b> <i>Stienis dvieļiem (60 cm)</i> 	<del>27.45</del>	1131031	<del>12.68</del>
	132	<b>15.00</b>	205
<b>84224DC</b> <i>Dubultais stienis dvieļiem (60 cm)</i> 	<del>41.93</del>	1131032	<del>9.40</del>
	132	<b>20.00</b>	95
<b>84280C</b> <i>Stienis dvieļiem</i> 	<del>13.31</del>	1131033	<del>21.54</del>
	21	<b>8.20</b>	95
<b>84282C</b> <i>Āķītis</i> 	<del>9.47</del>	1131035	<del>7.13</del>
	1	<b>7.00</b>	308
<b>84284C</b> <i>Glāze ar sienas stiprinājumu</i> 	<del>15.64</del>	1131055	<del>5.30</del>
	257	<b>7.30</b>	308
<b>84284DC</b> <i>Dubulta glāze ar sienas stiprinājumu</i> 	<del>18.22</del>	1131036	<del>11.31</del>
	68	<b>10.00</b>	60
<b>84285C</b> <i>Ziepju trauks (stikla)</i> 	<del>14.53</del>	1131037	<del>8.30</del>
	222	<b>7.20</b>	60
<b>84288C</b> <i>Poda birste ar keramikas trauciņu</i> 	<del>19.76</del>	1131040	<del>8.30</del>
	101	<b>11.70</b>	
<b>84711</b> <i>Ziepju trauks, metāla</i> 	<del>8.48</del>	1131056	<del>7.13</del>
	308	<b>6.00</b>	308
<b>84724C</b> <i>Stienis dvieļiem (60 cm)</i> 	<del>12.68</del>	1131058	<del>9.40</del>
	205	<b>9.40</b>	95
<b>84724DC</b> <i>Dubultais stienis dvieļiem (60 cm)</i> 	<del>21.54</del>	1131059	<del>11.31</del>
	95	<b>16.00</b>	60
<b>84784C</b> <i>Glāze ar sienas stiprinājumu</i> 	<del>7.13</del>	1131062	<del>8.30</del>
	308	<b>5.30</b>	60
<b>84788</b> <i>Poda birste ar keramikas trauciņu</i> 	<del>11.31</del>	1131067	<del>8.30</del>
	60	<b>8.30</b>	

## VANNAS ISTABAS AKSESUĀRI

EUR		EUR	
86085	Ziepju trauks	86087	Stikla plaukts
<del>15.02</del> 7131006		<del>24.66</del> 7131001	
214	8.80	139	13.50
86024	Stienis dvieļiem (60 cm)	86088	Poda birste ar keramikas trauciņu
<del>23.18</del> 7131007		<del>22.36</del> 7131002	
211	14.00	171	13.50
86081	Šķidro ziepju trauks ar turētāju	H 132	Metāla plauktiņš vannas iztabai
<del>16.57</del> 7131003		320x232x45	
221	10.00	7.33	1131085
86080	Stienis dvieļiem	24	5.40
<del>12.90</del> 7131004		H 210	Metāla plauktiņš vannas iztabai
176	7.80	155x125x32	
86082D	Āķītis	3.12	1131086
<del>10.78</del> 7131008		28	2.30
42	6.50	H 212	Metāla plauktiņš vannas iztabai
86084	Glāze ar sienas stiprinājumu	175x175x50	
<del>14.70</del> 7131009		3.12	1131087
223	8.80	41	2.30
			Glāze (stikla)
		<del>2.62</del> 1131093	
		114	1.60

## Invalīdu rokturi

EUR

*EQUA-1500 rokturis sienas stiprinājumu  
 ar atbalsta kāju 901*

**205.00** 2531001

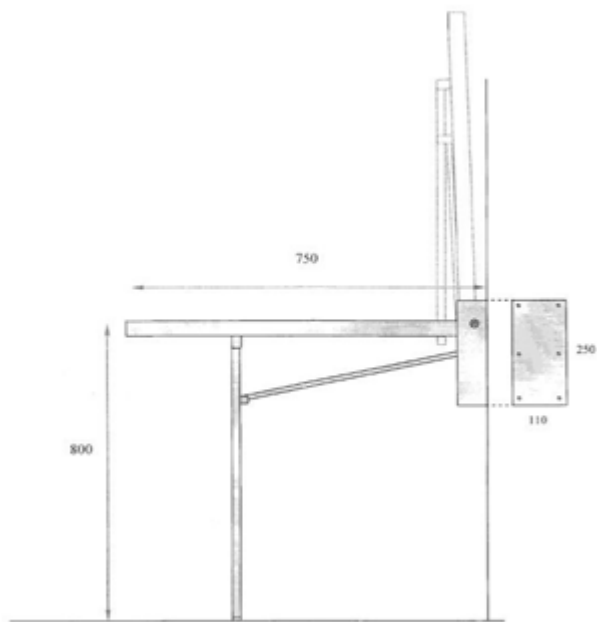

EUR

*EQUA-1501 rokturis sienas stiprinājumu  
 ar atbalsta kāju 902*



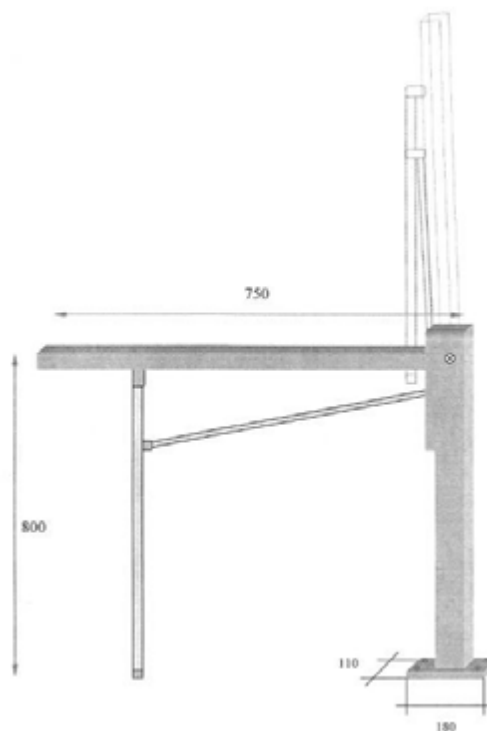





**255.00**

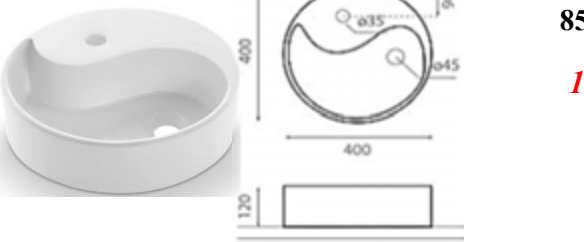
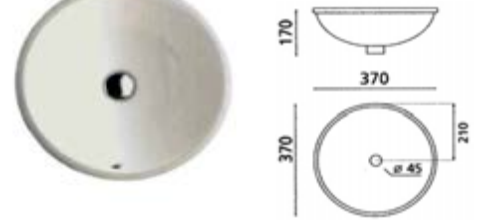

## UZLIEKAMĀS KERAMISKĀS IZLIETNES (SPĀNIJA)

VEIKALS EUR

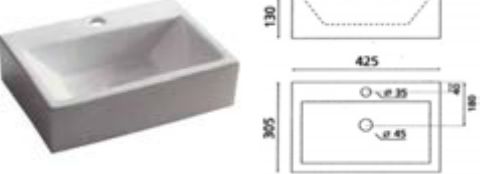
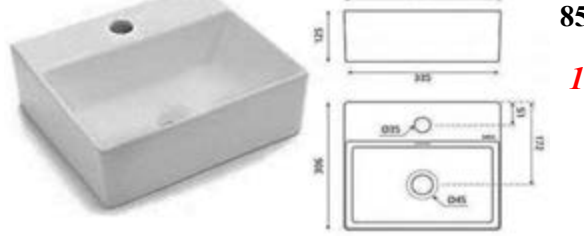
VEIKALS EUR

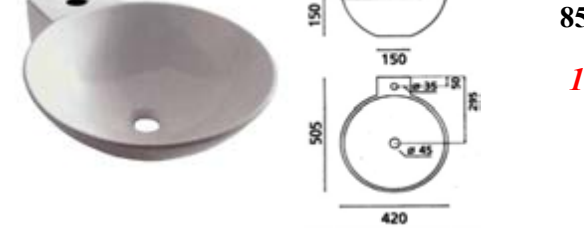
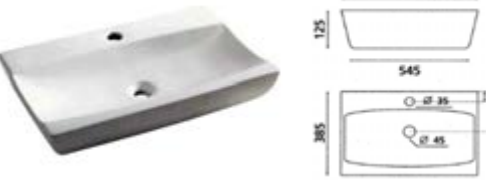
<p>0051B <b>TORINO B</b></p> <p>8575074 <b>132.60</b></p> 	<p>0011 <b>CAPRI</b></p> <p>8575025 <b>131.97</b></p> 
<p>0051 <b>TORINO</b></p> <p>8575073 <b>108.15</b></p> 	<p>0015 <b>CACERES</b></p> <p>8575005 <b>112.74</b></p> 
<p>0040B <b>YIN YANG</b></p> <p>8575045 <b>117.62</b></p> 	<p>0052 <b>CERDENA</b></p> <p>8575023 <b>97.89</b></p> 
<p>0087 <b>DALIA</b></p> <p>8575019 <b>90.11</b></p> 	<p>0037 <b>GERONA</b></p> <p>8575021 <b>126.47</b></p> 
<p>4913 <b>NEW BERGAMO</b></p> <p>8575102 <b>117.35</b></p> 	<p>4056 <b>FLORENCIA-A</b></p> <p>8575072 <b>123.73</b></p> 
<p>0028 <b>BAYONA</b></p> <p>8575009 <b>123.30</b></p> 	<p>0041 <b>SARDINERO</b></p> <p>8575022 <b>175.68</b></p> 

UZLIEKAMĀS KERAMISKĀS IZLIETNES (SPĀNIJA)

VEIKALS EUR

VEIKALS EUR

4122 **DINAN**  
 8575093  
**143.63**

4071 **OLEA**  
 8575035  
**157.46**

0043 **OPORTO**  
 8575013  
**177.11**

0025 **RIMINI**  
 8575044  
**185.05**

4010 **TT2**  
 8575052  
**182.21**

0023 **MANCHESTER**  
 8575029  
**254.42**

0034N **MALAGA NEW**  
 8575088  
**212.85**

0024 **VENEZIA**  
 8575030  
**188.95**

0062 **FUNCHIAL**  
 8575043  
**147.56**











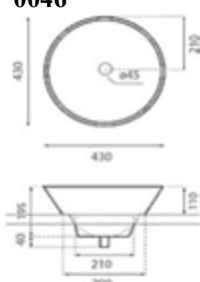

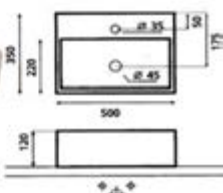

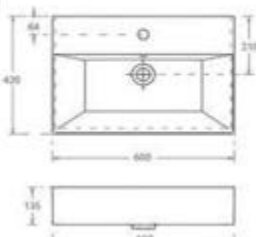

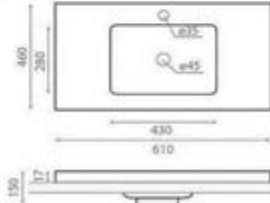

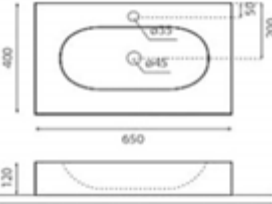

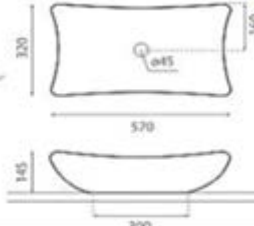

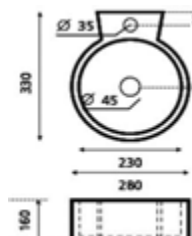
4088 **NILO 60**  
 8575083  
**391.51**

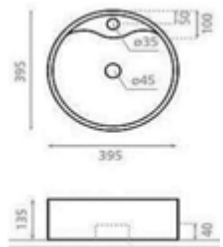
4020 **PURE**  
 8575058  
**179.11**

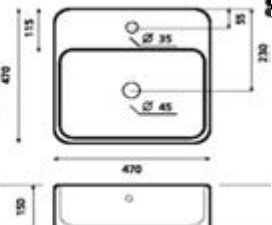
## UZLIEKAMĀS KERAMISKĀS IZLIETNES (SPĀNIJA)

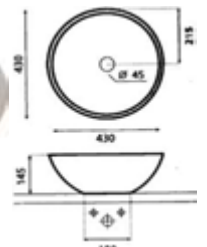
VEIKALS EUR

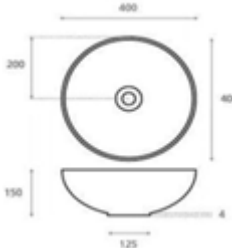
VEIKALS EUR

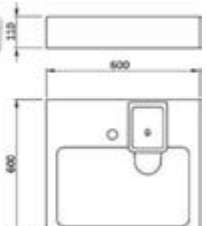
<p>0046 <b>NAPOLAS</b></p>   <p>8575063 <b>130.07</b></p>	<p>0017B <b>TURIN</b></p>   <p>8575050 <b>179.11</b></p>
<p>4106 <b>BRUSELAS</b></p>   <p>8575085 <b>236.73</b></p>	<p>4065 <b>LIEBANA 60</b></p>   <p>8575103 <b>137.89</b></p>
<p>0078 <b>ICE CREAM</b></p>   <p>8575046 <b>204.03</b></p>	<p>0092B <b>MAGDALENA</b></p>   <p>8575002 <b>189.77</b></p>
<p>0066 <b>JEREZ</b></p>   <p>8575028 <b>113.54</b></p>	<p>0040N <b>VIENA NEW</b></p>   <p>8575106 <b>145.60</b></p>
<p>0064 <b>OROTAVA</b></p>   <p>8575031 <b>129.98</b></p>	<p>0012B <b>CASTELLON</b></p>   <p>8575038 <b>123.02</b></p>
<p>4069 <b>SICILIA</b></p>   <p>8575081 <b>134.68</b></p>	<p>WBX101 <b>Uz velas mašīnas</b></p>   <p>8275042 <b>179.39</b></p>



## UZLIEKAMĀS KERAMISKĀS IZLIETNES (SPĀNIJA)

VEIKALS EUR



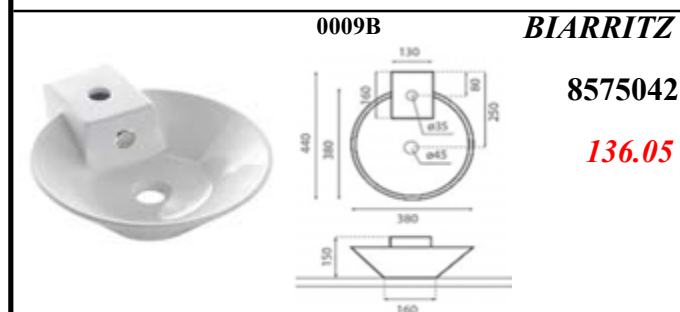
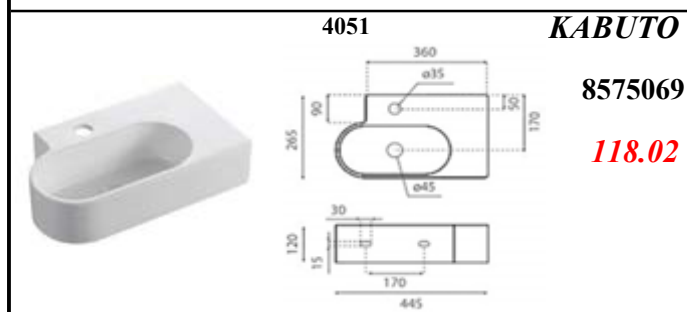
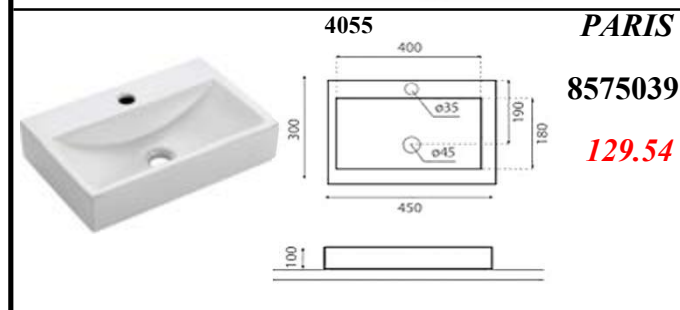
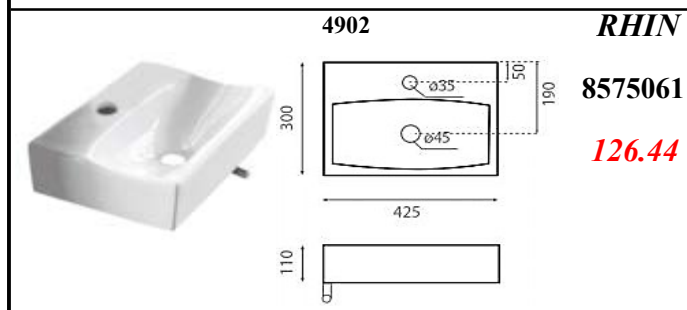
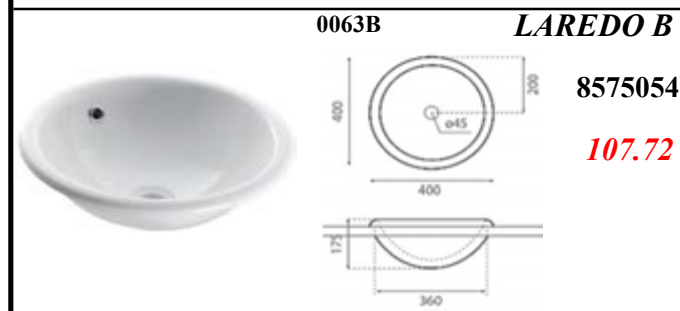
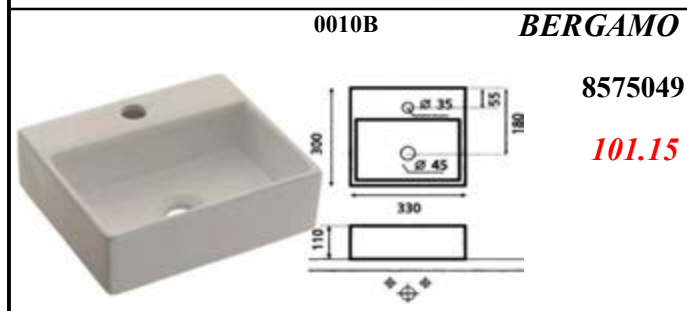
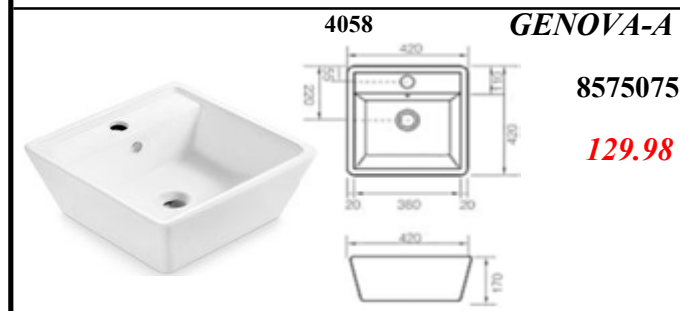
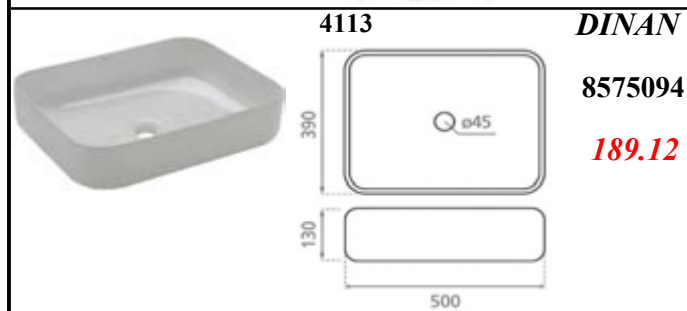
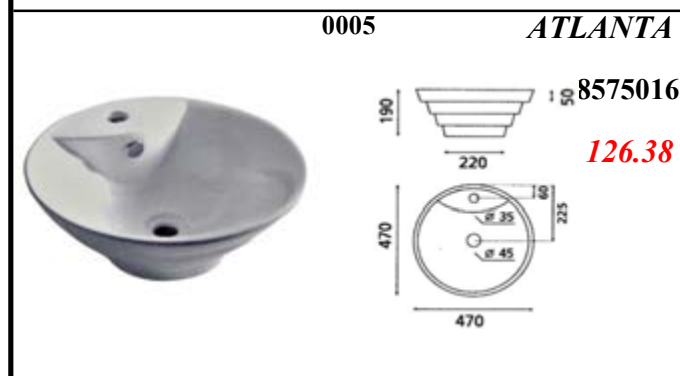
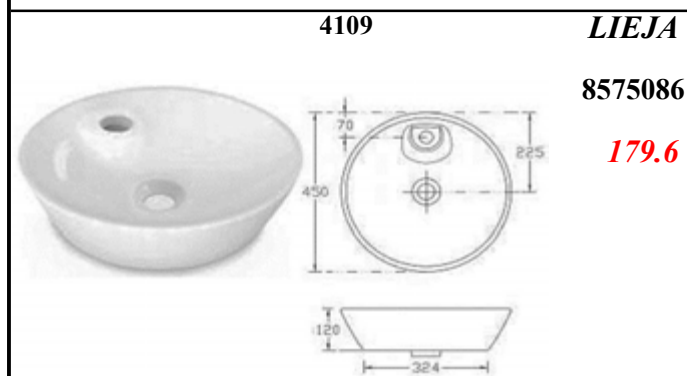
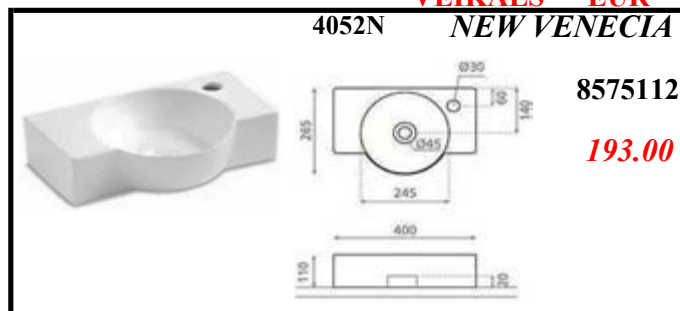
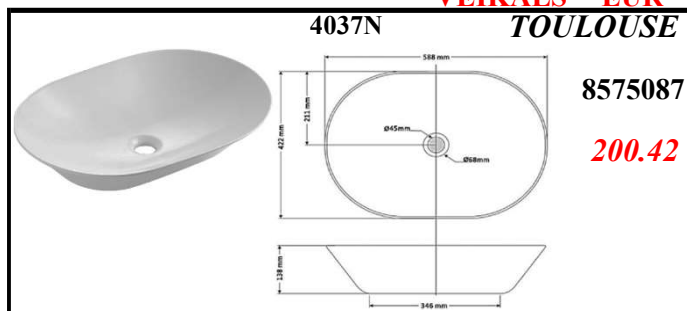



VEIKALS EUR

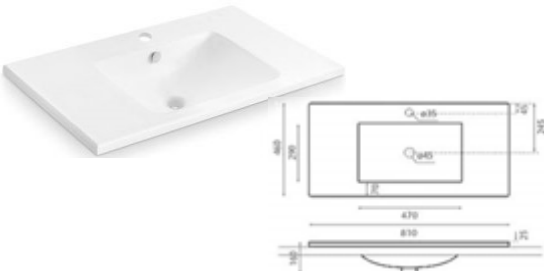
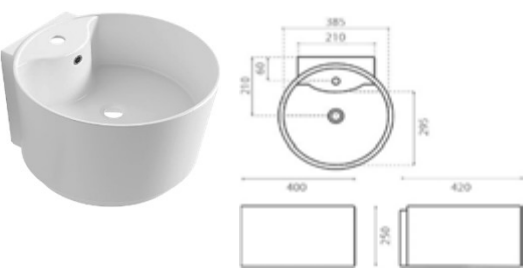
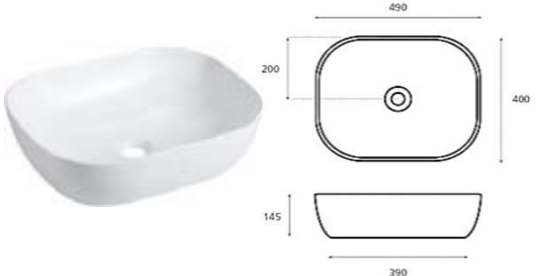

## UZLIEKAMĀS KERAMISKĀS IZLIETNES (SPĀNIJA)

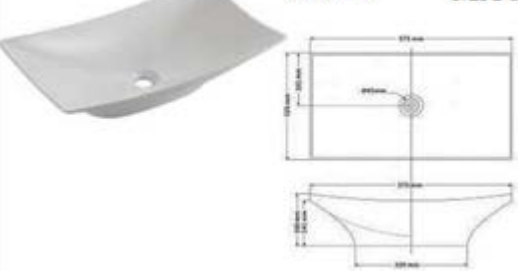
VEIKALS EUR

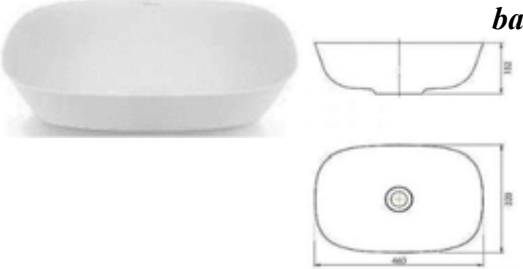
VEIKALS EUR

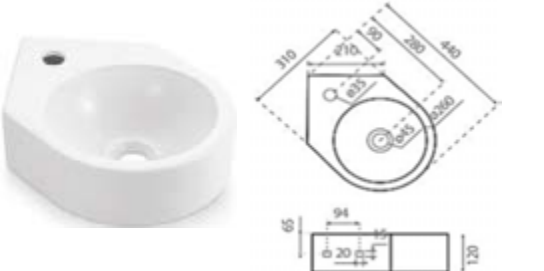
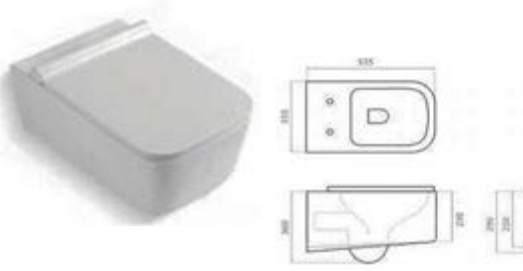
<p>4012/NM <b>NUEVO</b></p>  <p>8575008 <b>187.04</b></p>	<p>H1012 <b>HAMBURG</b></p>  <p>8575010 <b>197.30</b></p>
<p>4072 <b>OLEA</b></p>  <p>8575017 <b>175.06</b></p>	<p>4131 <b>BARI</b></p>  <p>8575015 <b>154.46</b></p>
<p>0017D <b>GOMERA</b></p>  <p>8575068 <b>132.42</b></p>	<p>0092BN <b>MAGDALENA</b></p>  <p>8575099 <b>204.65</b></p>
<p>0067 <b>DUBLIN</b></p>  <p>8575059 <b>120.80</b></p>	<p>6039 <b>MENDOZA</b> balta/matēta</p>  <p>8575101 <b>330.43</b></p>
<p>4087 <b>VOLTA 42</b> 420x125</p>  <p>8575080 <b>185.71</b></p>	<p>4029 <b>CALIFORNIA 70</b></p>  <p>8575089 <b>153.82</b></p>
<p>4049 <b>BRISTOL</b></p>  <p>8575064 <b>109.08</b></p>	<p>4533/UF <b>YUCON</b></p>  <p>8577004 <b>272.53</b></p>

## WATEX ūdens filtri

VEIKALS EUR

SNOW PAD

Dzeramā ūdens filtrs



530.40

8226010

BNT-RO75-C30

Dzeramā ūdens filtrs



219.38

8226011

HT SILVER

Ultrafiltrācijas sistēma



121.84

8226012

VEIKALS EUR



B008

5.02

2826008

B15 filtra kartridžs  
170 l

Krūzēm: Standart



B006

8.67

2826013

B5 filtra kartridžs  
300 l

Krūzēm: Smile, Prestige un Provance



A5

350 l

9.71 2826010

Krūzēm: Smile, Prestige un Provance

A10

AQUAPHOR FORAZ  
mūļas filtra kartridžs









1.39







2826011

**Uz pasūtījumu**

**VEIKALS  
EUR**

**VEIKALS  
EUR**

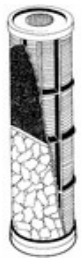







	331000	Aqua KID 5"-1/2"	<b>16.11</b>	<b>2326047</b>	<i>Aqua KID</i>
	331010 331012 331014	FP3 5"-1/2" FP3 5"-3/4" FP3 5"-1"	<b>16.88</b> <b>16.90</b> <b>17.23</b>	<b>2326038</b> <b>2326053</b> <b>2326051</b>	<i>FP3 5"</i>
	331016 331017 331018	FP3 7"-1/2" FP3 7"-3/4" FP3 7"-1"	<b>18.11</b> <b>18.18</b> <b>19.25</b>	<b>2326042</b> <b>2326064</b>	<i>FP3 7"</i>
	331020 331022 331024	FP3 10"-1/2" FP3 10"-3/4" FP3 10"-1"	<b>16.69</b> <b>18.33</b> <b>15.96</b>	<b>2326001</b> <b>2326034</b> <b>2326045</b>	<i>FP3 10"</i>
	331030 331032	FP3 20"-3/4" FP3 20"-1"	<b>57.01</b> <b>56.76</b>	<b>2326073</b>	<i>FP3 20"</i>
	331050 331052	FO3 10"-3/4" FO3 10"-1"	<b>131.14</b> <b>136.85</b>	<b>2326052</b>	<i>FO3 10"</i>
	331320	Vital	<b>10.14</b>	<b>2326023</b>	<i>Vital (velas mašīnas filtrs)</i>
	332002	1/2"	<b>13.82</b>	<b>2326032</b>	<i>Mignon 5" 3P 90-tips</i>
	332000	1/2"	<b>13.50</b>	<b>2326002</b>	<i>Mignon 5" 3P 180-tips</i>















	331202	Aqua KID 5" RLA	<b>6.08</b>	<b>2326009</b>	<i>Aqua KID 5" RLA (neilons)</i>
	331203 331204 331206	7" RLA 10" RLA 20" RLA	<b>7.60</b> <b>7.78</b> <b>20.83</b>	<b>2326008</b>	<i>RLA (neilons)</i>
	331210 331212	5"AC 10"AC	<b>28.06</b> <b>38.86</b>	<b>2326030</b> <b>2326031</b>	<i>AC (nerūs.tēr. siets)</i>
	331240 331242	5" RLA-CA 10" RLA-CA	<b>10.81</b> <b>13.65</b>	<b>2326025</b> <b>2326024</b>	<i>RLA-CA(neil.+ogle)</i>
	331250 331252	5" RLA-CP 10" RLA-CP	<b>8.23</b> <b>20.14</b>	<b>2326026</b> <b>2326027</b>	<i>RLA-CP(neil.+polifosfāts)</i>
	331362		<b>4.67</b>	<b>2326035</b>	<i>Filtra elements 5" dzeltens (PL, 10mikr)</i>  Mehāniskais elements + polifosfāta sāļi. Šis aukstā ūdens filtrējošais elements nodrošinās ūdens attīrīšanu no mehāniskajiem piemaisījumiem, rūsas, nogulsniem. Polifosfāta sāļi, kas ir filtrējošā elementa sastāvā, reaģējot ar ūdenī esošo kalciju, pārveido kaļķa ķīmisko formulu un mīkstina ūdeni, tādā veidā pasargājot sadzīves tehniku no kaļķakmens veidošanās. Maksimālā ūdens t. 38° C. Šis ir labākais ūdens filtrs Jūsu veļasmašīnai, ūdens boileram vai citai ūdens sildierīcei. Nav ieteicams dzeramajam ūdenim.

**Uz pasūtījumu**







**VEIKALS  
EUR**



**VEIKALS  
EUR**

		AQUA CV kārtidža	
331260	5"	3.54	
331262	10"	4.53	
		CA ogle	
331280	5"	4.17	2326011
331282	10"	7.13	2326010
331284	20"	18.26	2326074
		CA +I (jonīts + ogle)	
331286	10" CA+I	6.69	2326067
		CP polifosfāts	
331290	5"	9.01	2326041
331292	10"	13.57	2326003
331294	20"	33.7	
		FA-CA (polipr. + ogle)	
331310	5"FA-CA	8.65	2326028
331312	10"FA-CA	11.11	2326029
		Aqua KID FA 5" 10mikroni	
331328	Aqua KID FA 5"	3.12	2326049
		FA 5mikroni	
331330	FA 5"	2.49	2326007
331331	FA 7"	2.71	2326059
331332	FA 10"	3.03	2326006
331334	FA 20"	6.35	2326063
		FA Mignon 10 mikroni	
332200	FA 5"	2.64	2326033
332203	FA10" - R	2.71	2326014

		Metāla stiprinājums Aqua	
331500		6.32	2326012
		Plastmasas stiprinājums Aqua FP3	
331502		3.76	2326043
		Plastmasas dubultstiprinājums Aqua	
331504		6.97	2326056
		Misiņa atslēga FO3	
331508		7.56	2326054
		Atslēga Aqua korpusiem	
331510		2.64	2326036
		Atslēga Aqua KID korpusiem	
331516		2.39	2326050
		Atslēga L-tipa mignon korpusiem	
332304		2.94	2326048
		Polifosfāta kristāli	
331522	Paciņa 800 gr	10.25	2326040
331534	25 kg	238.24	
		Aktīvā ogle	
331524	Paciņa 280 gr	2.39	2326044
331536	25 kg	156	
		Aktīvā ogle+sudrabs	
331526	Paciņa 250 gr	5.71	2326078
331538	25 kg	35.51	
		Aktīvā ogle+jonizators	
331528	Paciņa 400 gr	2.83	2326013
		Katjona jonīts (10" elementu uzpildei)	
331530	Paciņa 250 gr	3.67	2326072
331532	25 litri	81.98	
		Blīve kārtidžām	
331540		0.89	
		O-ring filtru korpusiem	
331542	FP3	2.18	2326066
331541	Aqua Kid	1.93	2326070



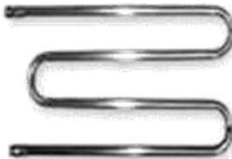
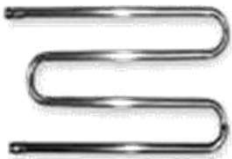

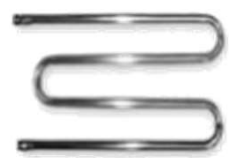
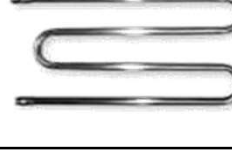

## Čūskveida divieļu žāvētaji



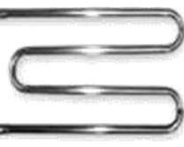



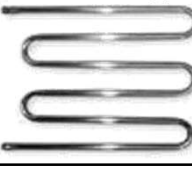





	VEIKALS	EUR
<i>"U veida" 1" (starpcentru attāl. 250 mm ± 15 mm)</i>		
	10013	400 <b>63.72</b>
	10020	450 <b>66.76</b>
	10037	500 <b>69.90</b>
	10044	550 <b>72.98</b>
	10051	600 <b>76.15</b>
	10068	650 <b>79.20</b>
	10075	700 <b>82.31</b>
	10082	750 <b>85.38</b>
	10099	800 <b>88.51</b>
	10105	850 <b>91.56</b>
	10112	900 <b>94.08</b>
<i>"U veida" 1 1/4" (starpcentru attāl. 250 mm ± 15 mm)</i>		
	10228	400 <b>83.60</b>
	10235	450 <b>87.51</b>
	10242	500 <b>91.71</b>
	10259	550 <b>95.80</b>
	10266	600 <b>100.00</b>
	10273	650 <b>104.20</b>
	10280	700 <b>108.40</b>
	10297	750 <b>112.06</b>
	10303	800 <b>116.16</b>
	10310	850 <b>120.36</b>
	10327	900 <b>124.28</b>
<i>"P veida" 3/4" (starpcentru attāl. 500mm ± 15 mm)</i>		
	11645*	500 x 500 <b>53.71</b>
	11652*	500 x 600 <b>59.42</b>
	11669*	500 x 700 <b>65.11</b>
	11881*	500 x 800 <b>70.76</b>
<i>"P veida" 1" (starpcentru attāl. 500mm ± 15 mm)</i>		
	11591*	500 x 500 <b>75.48</b>
	11614*	500 x 600 <b>82.42</b>
	11621*	500 x 700 <b>90.22</b>
	11638*	500 x 800 <b>97.04</b>
<i>"P veida" ar plauktiņu 1" (starpcentru attāl. 600 mm ± 15 mm)</i>		
	17746*	600 x 500 <b>90.01</b>
	17753*	600 x 600 <b>99.29</b>
	17760*	600 x 700 <b>107.13</b>
	18903*	600 x 800 <b>111.60</b>
<i>"P veida" 1 1/4" (starpcentru attāl. 500mm ± 15 mm)</i>		
	11898*	500 x 500 <b>99.08</b>
	11904*	500 x 600 <b>104.98</b>
	11911*	500 x 700 <b>115.69</b>
	11928*	500 x 800 <b>127.69</b>
<i>"Eiro" 1/2" (starpcentru attāl. 500mm ± 15 mm)</i>		
	14639	500 <b>184.53</b>

	VEIKALS	EUR
<i>"M veida" 3/4" (starpcentru attāl. 350 mm ± 15 mm)</i>		
	10921	400 <b>69.97</b>
	10938	450 <b>74.23</b>
	10945	500 <b>78.46</b>
	10952	550 <b>82.70</b>
	10969	600 <b>86.96</b>
	10976	650 <b>91.28</b>
	10983	700 <b>95.47</b>
	10990	750 <b>98.25</b>
	11003	800 <b>104.01</b>
	<i>"M veida" 3/4" (starpcentru attāl. 500 mm ± 15 mm)</i>	
	11324	400 <b>72.08</b>
	11331	450 <b>76.34</b>
	11348	500 <b>80.59</b>
	11355	550 <b>84.87</b>
	11362	600 <b>89.13</b>
	11379	650 <b>93.39</b>
	11386	700 <b>97.62</b>
	11393	750 <b>101.88</b>
	11409	800 <b>106.09</b>
	<i>"M veida" 1" (starpcentru attāl. 500 mm ± 15 mm)</i>	
	10365	400 <b>85.38</b>
	10372	450 <b>91.56</b>
	10341	500 <b>97.79</b>
	10396	550 <b>104.01</b>
	10402	600 <b>110.19</b>
	10419	650 <b>116.46</b>
	10389	700 <b>122.61</b>
	10426	750 <b>128.84</b>
	10433	800 <b>135.04</b>
	<i>"M veida" 1" (starpcentru attāl. 600 mm ± 15 mm)</i>	
	13717*	500 <b>117.36</b>
	13724*	550 <b>124.81</b>
	13731*	600 <b>132.26</b>
	13748*	650 <b>139.74</b>
	13755*	700 <b>147.12</b>
	13762*	750 <b>154.59</b>
	13779*	800 <b>162.02</b>
	<i>"M veida" 1" (starpcentru attāl. 600 mm ± 15 mm) Iekšējā vītne 1/2"</i>	
	12055*	700 <b>122.10</b>

\* - ražošanas laiks 1-2 dienas

## Čūskveida divieļu žāvētāji







	VEIKALS	EUR
<i>"M veida" ar plauktiņu1" (starpcentru attāl. 600 mm ± 15 mm)</i>		
	13601	500 <b>126.94</b>
	12215	600 <b>142.81</b>
	12246	700 <b>158.71</b>
	12253	800 <b>174.63</b>
<i>"M veida" 11/4" (starpcentru attāl. 550 mm ± 15 mm)</i>		
	11430*	400 <b>133.68</b>
	11447*	450 <b>142.88</b>
	11546*	500 <b>152.25</b>
	11454*	550 <b>161.60</b>
	11560*	600 <b>171.00</b>
	11461*	650 <b>185.92</b>
	11584*	700 <b>189.62</b>
	11478*	750 <b>198.99</b>
	11607*	800 <b>208.32</b>
	11485*	850 <b>220.75</b>
<i>"3 Vīļņu" 3/4" (starpcentru attāl. 580 mm ± 15 mm)</i>		
	11126	400 <b>97.11</b>
	11133	450 <b>102.46</b>
	11140	500 <b>107.76</b>
	11157	550 <b>117.11</b>
	11164	600 <b>120.53</b>
	11171	650 <b>125.83</b>
	11188	700 <b>131.15</b>
<i>"3 Vīļņu" 1/2" (starpcentru attāl. 600 mm ± 15 mm)</i>		
	18408*	500 <b>99.61</b>
	17685*	600 <b>105.07</b>
	18415*	700 <b>110.51</b>
<i>"3 Vīļņu" 1" (starpcentru attāl. 850 mm ± 15 mm)</i>		
	10549	500 <b>134.92</b>
	10556	550 <b>143.55</b>
	10563	600 <b>152.07</b>
	10570	650 <b>160.72</b>
	10587	700 <b>169.19</b>
<i>"3 Vīļņu" 1/2" (starpcentru attāl. 850 mm ± 15 mm)</i>		
	18422	500 <b>107.27</b>
	18439*	600 <b>111.71</b>
<i>"Taurenis" 3/4" (starpcentru attāl. 250 mm ± 15 mm)</i>		
	13830*	500 <b>105.24</b>
	13847*	550 <b>110.81</b>
	13854*	600 <b>116.37</b>
	13861*	650 <b>121.94</b>
	13878*	700 <b>127.45</b>
	13885*	750 <b>132.98</b>
	13892*	800 <b>138.51</b>
<i>"Taurenis" 1" (starpcentru attāl. 250 mm ± 15 mm)</i>		
	10723	600 <b>125.55</b>
	10730	650 <b>132.35</b>
	10747	700 <b>139.07</b>
	10754	750 <b>145.84</b>
	10761	800 <b>152.56</b>





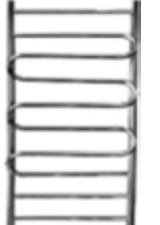
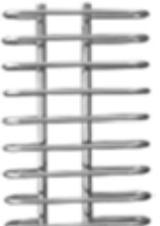

	VEIKALS	EUR
<i>"Step" 1" (starpcentru attāl. 500mm ± 15 mm)</i>		
	19351*	500 x 500 <b>179.91</b>
	19368*	500 x 600 <b>183.79</b>
	19375*	500 x 700 <b>192.05</b>
	19382*	500 x 800 <b>195.36</b>
<i>"Step" 1" (starpcentru attālums 600mm ± 15 mm)</i>		
	19399*	600 x 500 <b>188.86</b>
	19405*	600 x 600 <b>192.96</b>
	19412*	600 x 700 <b>201.66</b>
	19429*	600 x 800 <b>205.13</b>
<i>"Džaz" 1" (starpcentru attāl. 500mm ± 15 mm)</i>		
	18941	500 x 500 <b>138.74</b>
	18965	500 x 600 <b>146.08</b>
	18958	500 x 700 <b>156.28</b>
	18972	500 x 800 <b>165.37</b>
<i>"Džaz" 1" (starpcentru attāl. 600mm ± 15 mm)</i>		
	19474	600 x 500 <b>169.42</b>
	19481	600 x 600 <b>177.36</b>
	19498	600 x 700 <b>186.45</b>
	19504	600 x 800 <b>196.75</b>
<i>"Džaz" 11/4" (starpcentru attāl. 500mm ± 15 mm)</i>		
	19238*	500 x 500 <b>189.97</b>
	19245*	500 x 600 <b>193.60</b>
	19252*	500 x 700 <b>209.64</b>
	19269*	500 x 800 <b>223.73</b>
<i>"Džaz" 11/4" (starpcentru attālums 600mm ± 15 mm)</i>		
	19511*	600 x 500 <b>194.02</b>
	19528*	600 x 600 <b>205.15</b>
	19535*	600 x 700 <b>217.51</b>
	19542*	600 x 800 <b>230.90</b>
<i>"Fokstrots" 1" (starpcentru attāl. 500mm ± 15 mm)</i>		
	11874	500 x 500 <b>139.34</b>
	18866	500 x 600 <b>162.60</b>
<i>"Fokstrots" 1" (starpcentru attāl. 600mm ± 15 mm)</i>		
	14950*	600 x 500 <b>167.27</b>
	16862*	600 x 600 <b>178.40</b>
<i>Regulējams stiprinājums M8 ar gredzenu</i>		
	11683	D 20 3/4" <b>13.56</b>
	11690	D 25 1" <b>14.25</b>
	11706	D 32 11/4" <b>14.97</b>
<i>Neregulējams stiprinājums M8 ar gredzenu</i>		
	12000	D 20 3/4" <b>12.52</b>
	12017	D 25 1" <b>13.17</b>
	12024	D 32 11/4" <b>13.68</b>
<i>Noņemams, regulējams stiprinājums</i>		
	18910	D 20 3/4" <b>18.21</b>
	18927	D 25 1" <b>18.97</b>
	18934	D 32 11/4" <b>26.22</b>
<i>Amerikanka</i>		
	12864	D 20 3/4" <b>12.08</b>
	12871	D 25 1" <b>15.48</b>
	12888	D 32 11/4" <b>22.29</b>

## Pulēti nerūsējošā tērauda dvieļu žāvētāji

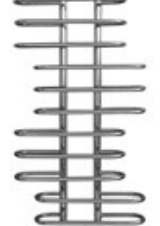
VEIKALS EUR

VEIKALS EUR

	<b>VIKTORIJA</b>	<i>Dvieļu žāvētājs bez plauktiņa</i>	14974 500*600 (5) <b>168.87</b>
			14561 500*700 (6) <b>195.15</b>
			14967 500*900 (7) <b>217.85</b>
			14554 500*1000 (8) <b>240.25</b>
	<b>VIKTORIJA +</b>	<i>Dvieļu žāvētājs ar plauktiņu starp ribām</i>	14905 500*600 (6) <b>215.93</b>
			14578 500*700 (7) <b>242.13</b>
			19672 500*900 (8) <b>247.91</b>
			14585 500*1000 (9) <b>259.43</b>
	<b>SONĀTE</b>	<i>Dvieļu žāvētājs bez plauktiņa</i>	14981 500*600 (5) <b>177.66</b>
			14615 500*700 (6) <b>200.98</b>
			14998 500*900 (7) <b>224.56</b>
			14622 500*1000 (8) <b>247.91</b>
	<b>SONĀTE +</b>	<i>Dvieļu žāvētājs ar plauktiņu starp ribām</i>	14912 500*600 (6) <b>220.77</b>
			14608 500*700 (7) <b>244.72</b>
			10198 500*900 (8) <b>258.11</b>
			14592 500*1000 (9) <b>267.16</b>
	<b>SONĀTE 2+</b>	<i>Dvieļu žāvētājs ar 2 plauktiņiem ribu vietā</i>	14929 500*900 (9) <b>263.39</b>
	<b>SONĀTE 3+</b>	<i>Dvieļu žāvētājs ar 3 plauktiņiem ribu vietā</i>	15001 500*900 (9) <b>270.45</b>
	<b>KAIJA</b>	<i>Dvieļu žāvētājs</i>	15025 500*600 (5) <b>313.19</b>
			15018 500*900 (7) <b>270.98</b>
	<b>TANGO</b>	<i>Dvieļu žāvētājs</i>	18026 500*1000 (3) <b>251.57</b>
	<b>ALLEGRO</b>	<i>Dvieļu žāvētājs</i>	18460 160*700*500 (7) <b>277.76</b>

	<b>TRIO</b>	<i>Dvieļu žāvētājs</i>	18477 400*700*600 (7) <b>268.62</b>
	<b>AKKORD</b>	<i>Dvieļu žāvētājs (pulēts)</i>	18484 160*700*650 (7) <b>277.76</b>
			18507 160*900*650 (9) <b>326.17</b>
			18521 160*1200*650 (11) <b>381.26</b>
	<b>AKKORD</b>	<i>Dvieļu žāvētājs (matēts)</i>	18491 160*700*650 (7) <b>313.97</b>
			18514 160*900*650 (9) <b>376.47</b>
			18538 160*1200*650 (11) <b>443.37</b>
	<b>GAMMA</b>	<i>Dvieļu žāvētājs (pulēts)</i>	18545 160*700*500 (7) <b>268.43</b>
			18569 160*900*500 (9) <b>316.86</b>
			18583 160*1200*500 (11) <b>371.94</b>
	<b>GAMMA</b>	<i>Dvieļu žāvētājs (matēts)</i>	18552 160*700*500 (7) <b>307.15</b>
			18576 160*900*500 (9) <b>367.19</b>
			18590 160*1200*500 (11) <b>434.09</b>
	<b>"W"</b>	<i>Dvieļu žāvētājs</i>	18897 500*600 (2) <b>190.60</b>
			18651 500*1000 (3) <b>250.27</b>
	<b>"E"</b>	<i>Dvieļu žāvētājs</i>	19320 500*600 (5) <b>177.20</b>
			18873 500*800 (6) <b>201.19</b>
			18880 500*1000 (6) <b>229.17</b>
			19559 500*1200 (8) <b>252.54</b>
	<b>"R"</b>	<i>Dvieļu žāvētājs</i>	19337 500*600 (5) <b>169.54</b>
			18804 500*800 (6) <b>196.10</b>
			18811 500*1000 (6) <b>220.68</b>





## Elektriskie nerūsējošā tērauda dvieļu žāvētāji

VEIKALS EUR

VEIKALS EUR

VIKTORIJA		<i>Dvieļu žāvētājs bez plauktiņa</i>			
	19016	200 W	500*600 (5)	<b>246.01</b>	
	19009	200 W	500*700 (6)	<b>273.59</b>	
	18989	200 W	500*900 (7)	<b>299.14</b>	
	18996	300 W	500*1000 (8)	<b>310.92</b>	

TANGO		<i>Dvieļu žāvētājs</i>			
	19184	300 W	500*1000 (3)	<b>336.23</b>	

VIKTORIJA +		<i>Dvieļu žāvētājs ar plauktiņu starp ribām</i>			
	*19023	200 W	500*600 (6)	<b>286.39</b>	
	*19030	200 W	500*700 (7)	<b>301.29</b>	
	19047	300 W	500*900 (8)	<b>306.91</b>	
	19054	300 W	500*1000 (9)	<b>316.22</b>	
* Žāvētājiem ar augstumu 600 un 700 mm, nav attēlā redzamās atstarpes					

ALLEGRO		<i>Dvieļu žāvētājs</i>			
	19191	200 W	160*700*500 (7)	<b>348.68</b>	

SONĀTE		<i>Dvieļu žāvētājs bez plauktiņa</i>			
	19092	200 W	500*600 (5)	<b>253.02</b>	
	19085	200 W	500*700 (6)	<b>277.60</b>	
	19078	300 W	500*900 (7)	<b>306.20</b>	
	19061	300 W	500*1000 (8)	<b>315.99</b>	

TRIO		<i>Dvieļu žāvētājs</i>			
	19207	200 W	400*700*600 (7)	<b>350.88</b>	

SONĀTE +		<i>Dvieļu žāvētājs ar plauktiņu starp ribām</i>			
	19108	200 W	500*600 (6)	<b>294.58</b>	
	19115	200 W	500*700 (7)	<b>308.03</b>	
	19122	300 W	500*900 (8)	<b>314.87</b>	
	19139	300 W	500*1000 (9)	<b>321.59</b>	

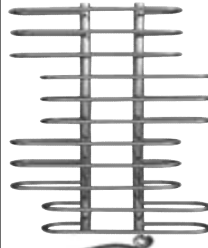
AKKORD		<i>Dvieļu žāvētājs (pulēts)</i>			
	19214	200 W	160*700*650 (7)	<b>363.49</b>	
	19221	300 W	160*900*650 (9)	<b>416.20</b>	
	17616	300 W	160*1200*650 (11)	<b>474.28</b>	

SONĀTE 2+		<i>Dvieļu žāvētājs ar 2 plauktiņiem ribu vietā</i>			
	19146	300 W	500*900 (9)	<b>320.57</b>	

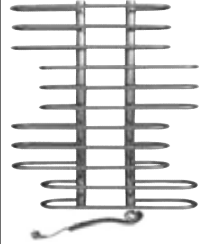
AKKORD		<i>Dvieļu žāvētājs (matēts)</i>			
	17623	200 W	160*700*650 (7)	<b>401.65</b>	
	17630	300 W	160*900*650 (9)	<b>469.23</b>	
	17647	300 W	160*1200*650 (11)	<b>539.67</b>	

SONĀTE 3+		<i>Dvieļu žāvētājs ar 3 plauktiņiem ribu vietā</i>			
	19153	300 W	500*900 (9)	<b>330.96</b>	

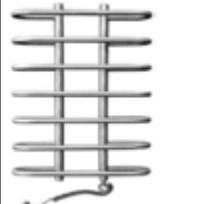

GAMMA		<i>Dvieļu žāvētājs (pulēts)</i>			
	17654	200 W	160*700*500 (7)	<b>539.67</b>	
	17661	300 W	160*900*500 (9)	<b>406.20</b>	
	17678	300 W	160*1200*500 (11)	<b>464.44</b>	

KAIJA		<i>Dvieļu žāvētājs</i>			
	19177	200 W	500*600 (5)	<b>298.89</b>	
	19160	200 W	500*900 (7)	<b>355.07</b>	

GAMMA		<i>Dvieļu žāvētājs (matēts)</i>			
	17692	200 W	160*700*500 (7)	<b>395.86</b>	
	17708	300 W	160*900*500 (9)	<b>459.33</b>	
	17722	300 W	160*1200*500 (11)	<b>530.07</b>	

## Dvieļu žāvētāji no cinkotās caurules

VEIKALS EUR

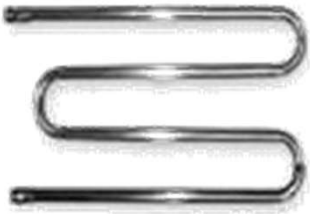
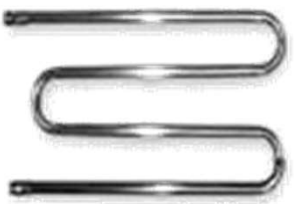
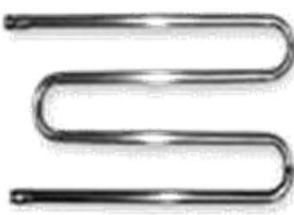
<i>"U veida" 1" (starpcentru attāl. 250 mm ± 15 mm)</i>			
	500	<b>33.41</b>	<b>3660206</b>
	600	<b>37.72</b>	<b>3660128</b>
	700	<b>41.93</b>	<b>3660075</b>
	800	<b>46.21</b>	<b>3660207</b>
<i>"U veida" 1 1/4" (starpcentru attāl. 250 mm ± 15 mm)</i>			
	500	<b>55.97</b>	<b>3660208</b>
	600	<b>63.61</b>	<b>3660209</b>
	700	<b>71.29</b>	<b>3660210</b>
	800	<b>78.93</b>	<b>3660102</b>
<i>"M veida" 3/4" (caurule 25.0x3.2starpcentru attāl. 500 mm ± 15 mm)</i>			
	400	<b>64.23</b>	<b>3660211</b>
	500	<b>68.21</b>	<b>3660212</b>
	600	<b>71.68</b>	<b>3660213</b>
	700	<b>75.02</b>	<b>3660214</b>
	800	<b>78.53</b>	<b>3660215</b>
	900	<b>82.17</b>	<b>3660216</b>
<i>"M veida" 1" (caurule 33.7x3.2starpcentru attāl. 500 mm ± 15 mm)</i>			
	400	<b>60.81</b>	<b>3660283</b>
	500	<b>71.99</b>	<b>3660217</b>
	600	<b>83.49</b>	<b>3660218</b>
	700	<b>95.26</b>	<b>3660124</b>
	800	<b>106.76</b>	<b>3660205</b>
<i>"M veida" 1.1/4" (caurule 42.4x3.2, starpcenru attāl. 550 mm ± 15 mm)</i>			
	500	<b>74.35</b>	<b>3660219</b>
	600	<b>85.08</b>	<b>3660220</b>
	700	<b>90.40</b>	<b>3660221</b>
	800	<b>95.82</b>	<b>3660222</b>

Cinkotie dvieļu žāvētāji ir ekonomiskās klases dvieļu žāvētāji, viņus pārsvarā izmanto objektos, kuros renovē vecos stāvvadus. Cinkotus ieteicams likt uz problēmatiskiem stāvvadiem, kur ir elektrokorozijas pazīmes, vai slikts ūdens, kā Jūrmalā. Varam piedāvāt arī krāsotus modeļus pēc RAL krāsu kataloga. Cena sadārdzinās par 30.00 eur. Krāsoti tiek ar pulverkrāsošanu. Cinkoti dvieļu žāvētāji ir ļoti izturīgi pret elektrokoroziju vai agresīvu ūdeni. Izmēri iespējami arī individuāli.

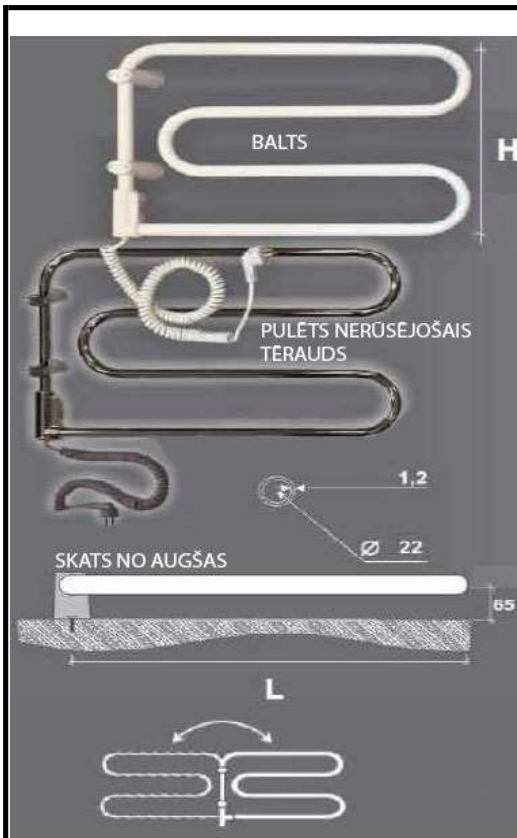

## DIVU VIĻŅU (STARP ASĪM H=340)

KLĀJUMS	BALTS (RAL 9010)	PULĒTS
PLATUMS	540	540
SVARS KG	1.86	1.98
JAUDA, W	45	45
CAURULES DIAMETRS	22 mm	22 mm
STIPRINĀJUMI	3	3
KODS	2160004	2160002
PIEGĀDĀTĀJA KODS	5890	5900
CENA EUR AR PVN	92.30	127.10

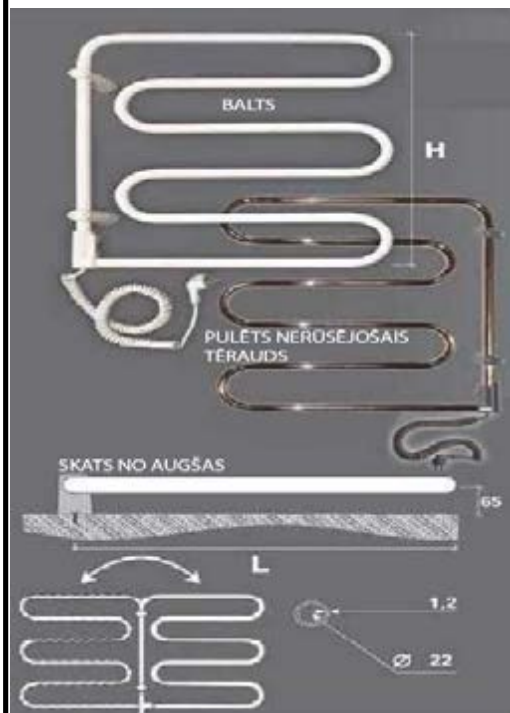

## TRĪS VIĻŅU (STARP ASĪM H=560)

KLĀJUMS	BALTS (RAL 9010)	PULĒTS
PLATUMS	520	520
SVARS KG	2.60	3.20
JAUDA, W	70	70
CAURULES DIAMETRS	22 mm	22 mm
STIPRINĀJUMI	3	3
KODS	2160005	2160003
PIEGĀDĀTĀJA KODS	5891	5902
CENA EUR AR PVN	117.74	174.41

## ČETRU VIĻŅU (STARP ASĪM H=780)

KLĀJUMS	BALTS (RAL 9010)	PULĒTS
PLATUMS	520	520
SVARS KG	3.47	3.47
JAUDA, W	100	100
CAURULES DIAMETRS	22 mm	22 mm
STIPRINĀJUMI	3	3
KODS	2160006	2160007
PIEGĀDĀTĀJA KODS	5893	5903
CENA EUR AR PVN	163.59	249.77



**Elektriskie dviēļu žāvētāji, baltie:** Izgatavoti no nerūsējošā tērauda caurules ar eiropas standartu - EN 10305-3. Caurules diametrs 22 mm, sienas biezums 1.2 mm. Lai izstrādājuma virsmu aizsargātu no virsmas korozijas, mehāniskiem bojājumiem un ķīmiskas iedarbības tērauda cauru virsma tiek slīpēta, attaukota un krāsota ar krāsu EPOXYPOL.TRIBO BT-55 Gloss 10/180°. Krāsa balta - RAL 9010.

**Nerūsējošā tērauda elektriskie dviēļu žāvētāji:** Izgatavoti no nerūsējošā tērauda caurules ar eiropas standartu - EN 10204. Caurules diametrs 22 mm, sienas biezums 1.5 mm.

Dviēļu žāvētāja iekšpusē ir pilnībā drošs sildkabelis. Dviēļu žāvētāja maksimālā uzsilšanas temperatūra ir +60°C, līdz ar to tas ir pilnībā drošs pret pieskārieniem.

VEIKALS EUR















VEIKALS EUR

SPL-Y		<i>Lampa Y</i>	
			9879002
	41	9.73	1.99
SPL-D3		<i>Lampa D3</i>	
			9879003
	6	7.64	1.49
SPL-D39		<i>Lampa D39</i>	
			9879001
	14	13.60	2.99
3.37	SPL-D240	<i>Lampas stikla daļas</i>	9879004
3.37	SPL-D165	<i>Lampas stikla daļas</i>	9879005

VEIKALS EUR

VEIKALS EUR

<i>Komplekts 1/2" ar smidzināšanas uzgali</i>			
	CL8802 BL	13.36	2363067
<i>Komplekts 3/4" ar smidzināšanas uzgali</i>			
	CL8827	18.49	2363101
			
<i>Smidzināšanas uzgalis Plus</i>			
	CL8536	5.44	2363070
			
<i>Smidzināšanas uzgalis Plus</i>			
	CL8537 BL	6.02	2363081
			
<i>Smidzināšanas uzgalis JET</i>			
	CL8616	3.84	2363021
			
<i>Smidzināšanas uzgalis JET (blister)</i>			
	CL8617 BL	5.24	2363022
			
<i>Smidzināšanas pistole SPRAY (blister)</i>			
	CL8756 BL	8.30	2363054
<i>Smidzināšanas pistole SPRAY</i>			
	CL8966	6.05	2363035
			
<i>Daudzfunkciju laistīšanas pistole Garden</i>			
	CL9373 BL	12.94	2363014
			
<i>Smidzināšanas pistole Ergo</i>			
	CL8538	8.50	2363062
			
<i>Smidzināšanas pistole Ergo</i>			
	CL8539 BL	9.76	2363074
			
<i>Smidzināšanas pistole ar kompl. ERGO</i>			
	CL8551 BL	18.50	2363103
			
<i>Smidzināšanas pistole Ergo</i>			
	CL8541 BL	13.54	2363091
			
<i>Laistīšanas pistole Ergo - Garden</i>			
	CL9391 BL	15.82	2363072
			
<i>Mazgāšanas pistole</i>			
	CL8757 BL	11.59	2363051
			
<i>Pistole laistīšanas Precision</i>			
	CL9561 BL	20.29	2363080
			









<i>Savienotājs ar iekšējo vītņi</i>				
	CL8622	1/2"	1.71	2363008
	CL8623 BL	1/2"	2.31	2363023
	CL8626	3/4"	1.61	2363009
	CL8627 BL	3/4"	2.26	2363094
	CL8628	1"	1.78	2363010
	CL8629 BL	1"	2.37	2363078
<i>Savienotājs ar ārējo vītņi</i>				
	CL8636	3/4"	1.60	2363007
	CL8637 BL	3/4"	2.03	2363075
<i>Remontuzmava</i>				
	CL8618	1/2"	2.37	2363019
	CL8620	5/8*3/4"	3.67	2363020
	CL8621	5/8*3/4"	4.40	2363084
	CL-8619 BL	1/2"	3.16	2363059
<i>Savienotājs</i>				
	CL8606	1/2"	2.33	2363001
	CL8607 BL	1/2"	3.49	2363041
	CL8608	3/4"	3.51	2363002
	CL8609 BL	3/4"	5.20	2363042
<i>Savienotājs ar aquastop</i>				
	CL8602	1/2"	3.75	2363003
	CL8604	3/4"	4.53	2363004
	CL8603 BL	1/2"	5.46	2363082
	CL8605 BL	3/4"	6.59	2363083
<i>Uzgalis ar 1/2" un 3/4" adapteri</i>				
	CL8591		2.47	2363043
<i>Uzgalis ar 1/2" un 3/4" adapteri (blister)</i>				
	CL8804 BL		2.92	2363102
<i>Savienotājs QUICK-FIT ar aeratoru</i>				
	CL8587 BL		19.28	2363073
<i>Blīvju remontkomplekts</i>				
	CL8811 BL		2.60	2363036
<i>Dīvgabals</i>				
	CL8612		1.95	2363005
	CL8613 BL		2.76	2363040
<i>Trejšgabals</i>				
	CL8614		3.44	2363006
	CL8615 BL		4.10	2363076
<i>Savienotājs Koala</i>				
	CL8583 BL		12.68	2363039
<i>Sadalītājs ar 2 izejām</i>				
	CL8598		10.11	2363052
	CL8599 BL		10.95	2363037
<i>Ar quick-click</i>				
<i>Sadalītājs ar 4 izejām</i>				
	CL8581 BL		31.25	2363038
<i>Savienotājs krānam ar I vai A vītņi 3/4"</i>				
	CL8597		18.32	2363099

**VEIKALS EUR**



**VEIKALS EUR**

	<i>Laistītājs Idrosprey 2000</i>	CL8675 BL	<b>27.43</b>	2363058
	<i>Daudzfunkciju laistīšanas ierīce</i>	CL8654 BL	<b>16.92</b>	2363024
	<i>Laistītājs Rollina</i>	CL8656	<b>10.94</b>	2363032
	<i>Laistītājs Turbospruzzo</i>	CL8658 BL	<b>9.44</b>	2363033
	<i>Laistītājs Compact 160 Promo</i>	CL8740 BL	<b>16.93</b>	2363027
	<i>Laistītājs Impact uz spraudņa</i>	CL8707 BL	<b>27.99</b>	2363086
	<i>Laistītājs Turbospike</i>	CL8660 BL	<b>8.15</b>	2363025
	<i>Automašīnas mazgājamā birste Wippy Car</i>	CL8774 BL	<b>12.63</b>	2363034
	<i>Sampūna stienīši WIPPY 10 gab</i>	CL8759 BL	<b>3.05</b>	2363066
	<i>Šļūteņu turētājs ECO O</i>	CL8866	<b>5.16</b>	2363068
	<i>Rati Genius 60</i>	CL8862	<b>60.37</b>	2363069
	<i>Rati, izjaucamie, Ecosei</i>	CL8980	<b>43.03</b>	2363090
	<i>Ūdens tvertne roku mazgāšanai 4L</i>	30005	<b>5.43</b>	4475001

\* krāsa var mainīties

	<i>Daudzfunkciju laistīšanas pistole QUICK EXCLUSIVE</i>	WL-EN9T	<b>14.64</b>	7863002
		10		
	<i>Daudzfunkciju laistīšanas pistole STANDART</i>	WL-EN1T	<b>10.23</b>	7863003
		10		
	<i>Smidzināšanas uzgalis</i>	WL-4710	<b>1.37</b>	7863001
		10		
	<i>Remontuzmava 1/2"</i>	WL-2100	<b>0.92</b>	7863020
		25/50		
	<i>Remontuzmava 3/4"</i>	WL-2110	<b>1.49</b>	7863021
		25/50		
	<i>Remontuzmava 1"</i>	WL-2112	<b>3.99</b>	7863022
		10		
	<i>Remontuzmava 1/2"x3/4"</i>	WL-2101	<b>1.68</b>	7863025
		25/50		
	<i>Remontuzmava 3/4"x1"</i>	WL-2111	<b>3.44</b>	7863026
		10		
	<i>Savienotājs ar aquastop 1/2"</i>	WL-2140	<b>1.65</b>	7863030
		25/50		
	<i>Savienotājs ar aquastop 3/4"</i>	WL-2150	<b>1.96</b>	7863031
		25/50		
	<i>Savienotājs ar iekšējo vītņi 1/2"</i>	WL-2196	<b>0.57</b>	7863015
		25/50		
	<i>Savienotājs ar iekšējo vītņi 3/4"</i>	WL-2195	<b>0.65</b>	7863016
		25/50		
	<i>Uzgalis 3/4" ar 1/2" adapteri</i>	WL-2198	<b>1.08</b>	7863010
		25/50		
	<i>Uzgalis 1" ar 3/4" adapteri</i>	WL-2199	<b>1.19</b>	7863011
		25/50		
	<i>Divgabals</i>	WL-2200	<b>0.70</b>	7863035
		25		

## LAISTĪŠANAS ŠLŪTENES

	VEIKALS	EUR	
			<i>Šļūtene IDRO GREEN</i>
	1/2"-25m	<b>10.57</b>	<b>2362001</b>
	1/2"-50m	<b>21.15</b>	<b>2362002</b>
	3/4"-25m	<b>21.14</b>	<b>2362003</b>
	3/4"-50m	<b>42.38</b>	<b>2362004</b>
	1"-25m	<b>44.90</b>	<b>2362042</b>
	1"-50m	<b>89.74</b>	<b>2362005</b>
			<i>Šļūtene MINT</i>
	1/2"- 25 m	<b>21.92</b>	<b>2362006</b>
	1/2"- 50 m	<b>43.80</b>	<b>2362007</b>
	3/4"- 25 m	<b>38.27</b>	<b>2362008</b>
	3/4 "-50 m	<b>76.52</b>	<b>2362009</b>
			<i>Šļūtene NTS ORANGE</i>
	1/2"-25m	<b>44.23</b>	<b>2362012</b>
	1/2"- 50 m	<b>87.63</b>	<b>2362013</b>
	3/4"- 25 m	<b>77.40</b>	<b>2362014</b>
	3/4 "-50 m	<b>153.25</b>	<b>2362015</b>
	1"x25 m	<b>125.67</b>	<b>2362045</b>
	1"x50 m	<b>251.20</b>	<b>2362016</b>

<p><b>UZ PASŪTĪJUMU</b></p>	<p>EPS200</p> <p><b>CapriTherm</b></p> <p>Siltuma vadītspēja 0,038W</p> <p>Karstumizturīgums 0,75(m<sup>2</sup>*k)/W</p>	<p>biezums 30mm</p>	<p><i>Putuāplasta plāksne 1M<sup>2</sup> siltajam grīdām ar izteiktām siltumizolācijas īpašībām</i></p> <p>5.53</p> <p>1781001</p>
<p><b>UZ PASŪTĪJUMU</b></p>	<p>ACU300</p> <p><b>CapriAcu</b></p> <p>Siltuma vadītspēja 0,045W</p> <p>Akustiskā klase PP-28</p> <p>Skņas reducēšana 28dB</p>	<p>biezums 30mm</p>	<p><i>Putuāplasta plāksne 1M<sup>2</sup> siltajam grīdām ar izteiktām skaņas izolācijas īpašībām</i></p> <p>5.61</p>
<p>2009</p>		<p>250gb.</p>	<p>Skavas caurulei</p> <p>17.66</p> <p>1722041</p>
	<p>7271S</p>	<p>200M/4 rullis 16x2.0</p> <p>200M/4 rullis 20x2.0</p>	<p><i>Pe-RT/EVOH/Pe-RT Caurule siltajam grīdām</i></p> <p>2.45</p> <p>2.45</p> <p>4219001</p> <p>4219002</p>
<p>91230</p>		<p>1gb</p>	<p><i>Takers skavas stiprināšanai</i></p> <p>260.86</p> <p>1735010</p>



## Roku tīrīšanas līdzekļi

VEIKALS

EUR

### Roku tīrīšanas līdzeklis CLEAN HARRY GREEN

3263

500 ml.

9.59

2172002



Rūpniecisks roku tīrīšanas līdzeklis. Paredzēts, lai notīrītu visgrūtāk tīrāmos traipus: taukus, eļļas, dubļus, krāsas, lakas. Ļoti efektīvs līdzeklis. Pilnībā notīra visu veidu netīrumus no rokām un nagiem.

Lieliski piemērots lietošanai mehāniķiem, virpotājiem, celtniekiem, šoferiem, darbiniekiem riepu veikalos, velosipēdistiem, iespaidējiem, u.t.t. Līdzeklis, kas ir nepieciešams katrā garāžā. Tam ir patīkama mandeļu smarža, sviesta konsistence. Krāsa-dzeltena. Sastāvs: glicerīns, lanolīns (aitas vilnas vaski). Nesatur abrazīvu.

Lietošana: Nemitrināt rokas pirms CLEAN HARRY GREEN lietošanas. Pēc lietošanas noslaucīt rokas ar dvieli vai nomazgāt ar ūdeni. Līdzekli drīkst izmantot bez ūdens.

Lietošana: Nemitrināt rokas pirms  
Iepakojums: 0,5 kg; 5 kg un 10 kg plastmasas spainīši.

### Roku tīrīšanas līdzeklis CLEAN HARRY BLUE

3266

500 ml.

4.72

2172003



Rūpniecisks roku tīrīšanas līdzeklis. Paredzēts, lai notīrītu visgrūtāk tīrāmos traipus: taukus, eļļas, dubļus, krāsas, lakas. Ļoti efektīvs līdzeklis. Pilnībā notīra visu veidu netīrumus no rokām un nagiem.

Lieliski piemērots lietošanai mehāniķiem, virpotājiem, celtniekiem, šoferiem, darbiniekiem riepu veikalos, velosipēdistiem, iespaidējiem, u.t.t. Līdzeklis, kas ir nepieciešams katrā garāžā.

Sastāvs: glicerīns, lanolīns (aitas vilnas vaski), abrazīvs, kas negrimst ūdenī un nepiesārņo sifonus.

Līdzeklim ir daļēji šķidra konsistence, piemīt patīkama citronu smarža. Krāsa-oranža. Lietošana: Nemitrināt rokas pirms lietošanas. Pēc lietošanas noslaucīt rokas dvielī vai nomazgāt ar ūdeni. Var lietot traukos ar dozatoru. Līdzeklis mazāk efektīvs nekā FELIX vai CLEAN HARRY GREEN.

Iepakojums: 0,5 kg; 5 kg un 10 kg plastmasas spainīši.

**Eko aizdedzināmie koksnes rullīši.**

Ekoloģisks un dabīgs produkts, kas nesatur kaitīgās, ķīmiskās un toksiskās vielas piemēram degvielas, spirtus, utt,





Piemērots kokskaidu briķešu, granulu, ogļu un malkas ātrai aizdedzināšanai, bez citu palīgmateriālu pielietošanas.

Pielietojams grilu, kamīnu, krāšņu un ugunsroku ātrai iekurināšanai. Derīgs arī lielākām pagalēm, koku zariem un pat mitrai meža malkai. Viena iekura gabaliņa degšanas ilgums ir apmēram līdz 10 minūtēm. Tas deg bez nepatīkamās smakas un dūmiem, to var uzglabāt telpās, jo no tā neizdalās nepatīkams aromāts, kas atgādina dažāda veida degvielas.

EKO FENIKS ir Izgatavots no tīras koksnes - vairākiem koku sugu veidiem, tā sastāvā ir tikai dabīgais vasks un koku sveķi.

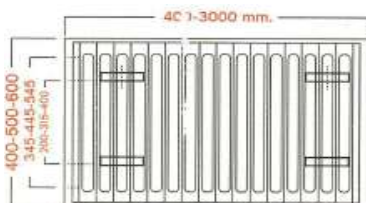
Aizdedzināmie atbilst: FSC-STD-40-004 V2-1; EN 186-3; Ražots ES, Polijā.





*EKO uguns iekurs FENIKS - 6***0.98 2295002***EKO uguns iekurs FENIKS - 16***2.54 2295003***EKO uguns iekurs FENIKS - 3***0.57 2295001**





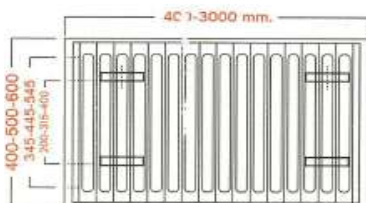
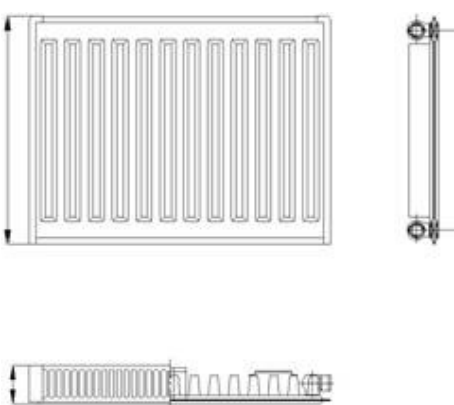

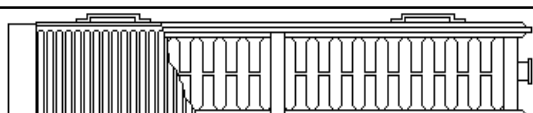



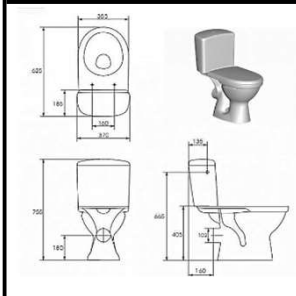

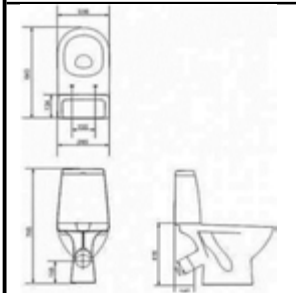
TYPE 22 PKKP	Augstums	Garums	Jauda W	VEIKALS EUR Cena	Kods
	400	500		66.53	4670002
	400	600		74.41	4670003
	400	800		94.69	4670005
	400	1000		112.75	4670007
	400	1200		132.66	4670009
	400	1400		152.27	4670010
<i>Itek/m = 24,00 Kg, paneļa biezums 1,25-1,20mm, komplektā ietilpst korķis, atgaisotājs un stiprinājumi</i>					
TYPE 22 PKKP	Augstums mm	Garums mm	Jauda W	Cena	Kods
	500	400	746	20.33	4670014
	500	500		65.01	4670015
	500	600		72.76	4670016
	500	700		82.61	4670017
	500	800		97.55	4670018
	500	900		108.63	4670019
	500	1000		116.13	4670020
	500	1200		136.54	4670022
	500	1400		148.84	4670023
	500	1600		170.23	4670024
	500	1800		189.39	4670025
500	2000		210.77	4670026	
<i>Itek/m = 28,90 Kg, paneļa biezums 1,25-1,20mm, komplektā ietilpst korķis, atgaisotājs un stiprinājumi</i>					
TYPE 22 PKKP	Augstums mm	Garums mm	Jauda W	Cena	Kods
					
<i>Itek/m = 34,60 Kg, paneļa biezums 1,25-1,20mm, komplektā ietilpst korķis, atgaisotājs un stiprinājumi</i>					
					

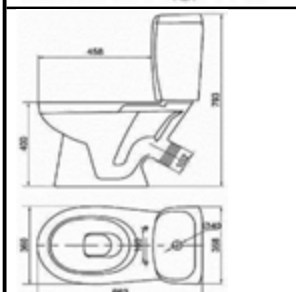



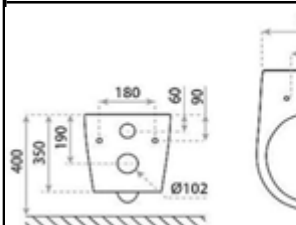
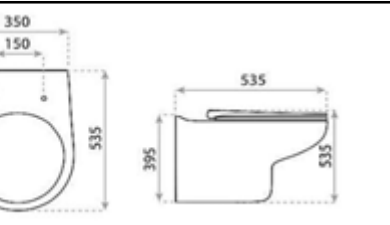



EN 442









TYPE 11 PK	Augstums	Garums	Jauda W	Cena	Kods
	400	800	721	20.47	4670040
<i>Itek/m = 11.40 Kg, paneļa biezums 1,25-1,20mm, komplektā ietilpst korķis, atgaisotājs un stiprinājumi</i>					
TYPE 11 PK	Augstums mm	Garums mm	Jauda W	Cena	Kods
					
<i>Itek/m = 14.20 Kg, paneļa biezums 1,25-1,20mm, komplektā ietilpst korķis, atgaisotājs un stiprinājumi</i>					
TYPE 11 PK	Augstums mm	Garums mm	Jauda W	Cena	Kods
					
<i>Itek/m = 17.00 Kg, paneļa biezums 1,25-1,20mm, komplektā ietilpst korķis, atgaisotājs un stiprinājumi</i>					
					
					
					

	<p>1612-B-R</p> 	<p><i>Kompaktpods Cersanit MERIDA ar vāku un horizontālu izvadu</i></p> <p><b>164.14</b> <b>7877001</b></p> 
		<p><i>Kompaktpods ar vāku un slīpu izvadu, MERIDA COMPACT 773</i></p> <p><b>177.03</b> <b>2577042</b></p> 
		<p><i>Kompaktpods ar vāku un slīpu izvadu, KORAL KORAL K031</i></p> <p><b>168.01</b> <b>2577041</b></p> 
	<p><i>Kompaktpods ar vāku un horizontālu izvadu, MILA 190031</i></p>	<p><b>108.33</b> <b>2577043</b></p>
	<p><i>Kompaktpods ar vāku un slīpu izvadu, MILA 190041</i></p>	<p><b>115.67</b> <b>2577044</b></p>
		<p><i>Piekaramais pods ARCTIC, Lavita</i></p> <p><b>110.40</b> <b>8277071</b></p>
		<p><i>Balts, poda vāks veidots no duroplasta ar montāžas stiprinājumiem. Universāls, saderīgs ar vairumu CERSANIT un KOLO ražoto podu.</i></p> <p><b>72.76</b> <b>7871004</b></p>
	<p><b>SOFT</b> <b>K980035</b></p>	<p><i>Vāks "MERIDA" podam, balts</i></p> <p><b>23.80</b> <b>7871001</b></p>

VEIKALS EUR











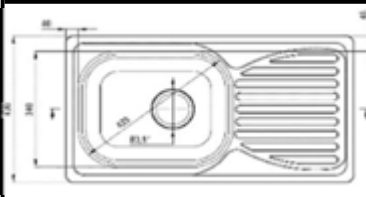
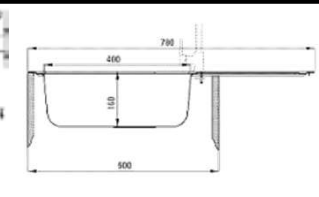

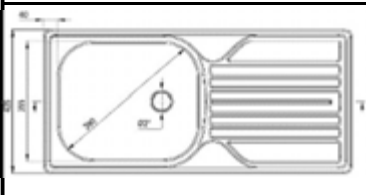
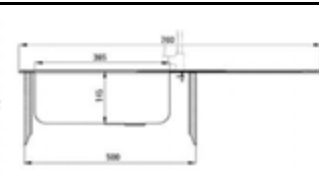
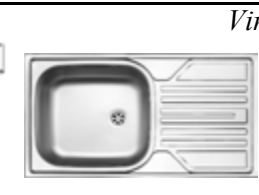
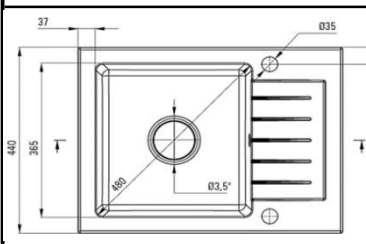
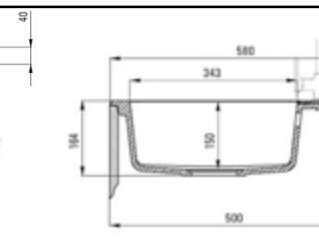
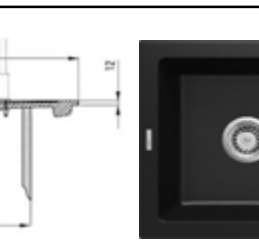
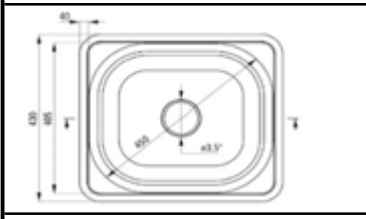
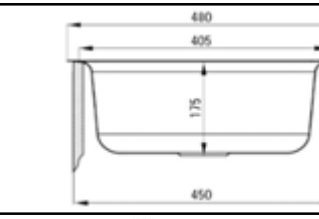

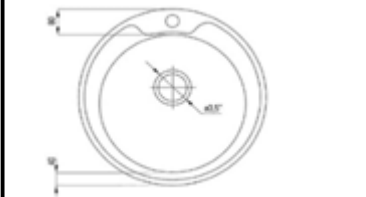
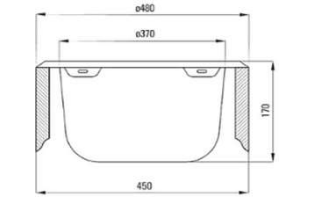
	<i>Skalojamā tvertne, keramiskā, LIDO podiem</i> WC skalojamā kaste "RIO", bez meh., attālums starp skrūvēm 135 mm	<b>32.89</b> <b>2571005</b>
	<i>Skapis ar izlietni</i> VENUS 45 430x810x250	<b>106.41</b>
	VENUS 50 450x810x290	<b>2576024</b> <b>131.53</b>
	VENUS 55 520x810x300	<b>144.84</b>
	<i>Skapis ar izlietni</i> MEA 60/1 600x800x400	<b>322.21</b>
	<i>Skapis ar izlietni</i> MEA 75 700x800x330	<b>2576021</b> <b>251.26</b>
	<i>Skapis ar izlietni</i> MEA 45 430x800x250	<b>2576019</b> <b>128.59</b>
	MEA 50 460x800x300	<b>152.22</b>
	MEA 55 530x800x310	<b>2576023</b> <b>168.50</b>
	MEA 65 620x800x300	<b>2576018</b> <b>206.92</b>
	<i>Skapis ar izlietni</i> CAPRI 55 BLACK 480x800x340	<b>322.21</b>
	<i>Skapis ar izlietni</i> CAPRI 55 480x800x340	<b>322.21</b>

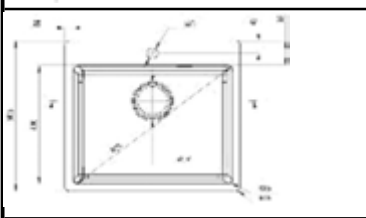
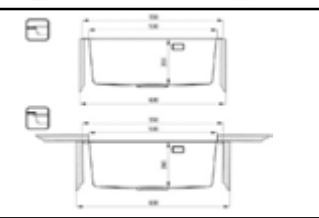
	<i>Skapis ar izlietni</i> ARMANDO 50/1 460x810x300	<b>165.53</b>
	ARMANDO 50/2 460x800x300	<b>2576020</b> <b>162.59</b>
	<i>Skapis ar izlietni</i> ARMANDO 50/3 460x810x300	<b>180.31</b>
	ARMANDO 50/4 460x800x300	<b>2576015</b> <b>177.36</b>
	<i>Skapis ar spoguli</i> ARMANDO E50 500x600x220	<b>2576011</b> <b>84.24</b>
	ARMANDO E60 600x600x220	<b>2576022</b> <b>91.64</b>
	<i>Skapis ar spoguli (stūra)</i> ARMANDO E40 400x730x230	<b>2576012</b> <b>79.82</b>
	<i>Skapis ar izlietni (stūra)</i> ARMANDO 50/5 550(360)x810x380	<b>2576017</b> <b>203.96</b>
	<i>Skapis ar izlietni</i> SAT 40 380x800x200	<b>140.40</b>
	<i>Skapis ar spoguli</i> SALSA 50 500x600x150	<b>2576025</b> <b>110.84</b>

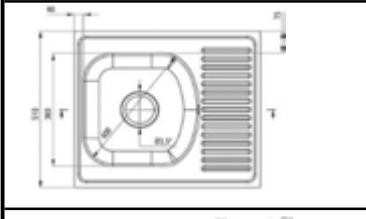
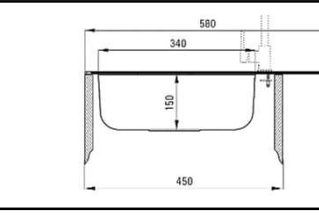
## VIRTUVES IZLIETNES

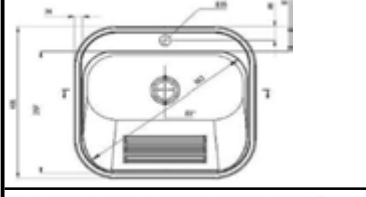
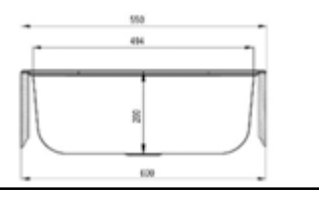
VEIKALS EUR

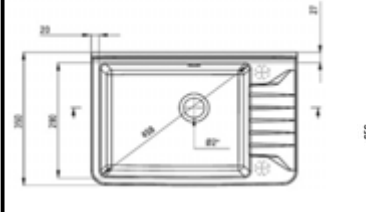
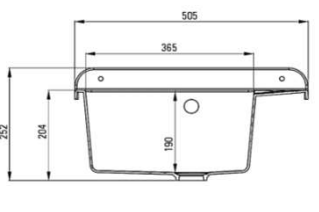
VEIKALS EUR

			<p><i>Virtuves izlietne DOPIO 780x430x160</i>                      Bez cauruma <b>57.20</b> 8275125                      Labā <b>57.20</b> 8275150                      Kreisā <b>57.20</b> 8275152                      Komplektācija: Sifons un notece</p>
			<p><i>Virtuves izlietne LEGATO 780x435x160</i>                      Bez cauruma <b>57.20</b> 8275126                      Labā <b>60.95</b> 8275149                      Kreisā <b>60.95</b> 8275151                      Komplektācija: Sifons un notece</p>
			<p><i>Virtuves izlietne ZQZ_N11A 580x440x164 granīta, melna</i>                      8275124  <b>122.20</b>                      Komplektācija: Sifons un notece</p>
			<p><i>Virtuves izlietne ZEN_0103 480x430x175</i>                      8275134  <b>52.90</b>                      Komplektācija: Sifons un notece</p>
			<p><i>Virtuves izlietne ZHC_0813 490x170</i>                      8275135  <b>60.95</b>                      Komplektācija: Sifons un notece</p>
			<p><i>Virtuves izlietne ZPO_010B 550x505x200</i>                      8275136  <b>193.45</b>                      Komplektācija: Sifons un notece</p>
			<p><i>Virtuves izlietne ZMU_0113 580x510x150</i>                      8275137  <b>56.90</b>                      Komplektācija: Sifons un notece</p>
			<p><i>Izlietne saimnieciskā, metāla ZYK_010B 495x550x200</i>                      8275138  <b>138.00</b>                      Komplektācija: Sifons un notece un stiprinājumi</p>
			<p><i>Izlietne saimnieciskā, polistirols ZYT_311A 505x341x252</i>                      8275143  <b>57.00</b>                      Komplektācija: Sifons un notece un stiprinājumi</p>

## VEIKALS

Izolācijas biezums mm	Čaulas iekšējais diametrs mm	Čaulas garums mm	Gabali iepakojumā	cena par gab
20	15	1 200	35	4.35
20	18	1 200	30	4.31
20	22	1 200	28	4.43
20	28	1 200	30	4.75
20	35	1 200	25	5.42
20	42	1 200	20	6.07
20	48	1 200	18	6.79
20	54	1 200	16	6.60
20	60	1 200	13	7.46
20	70	1 200	10	10.78
20	76	1 200	15	9.36
20	89	1 200	9	11.59

30	15	1 200	25	5.86
30	18	1 200	25	5.47
30	22	1 200	20	5.82
30	28	1 200	18	6.59
30	35	1 200	16	7.22
30	42	1 200	13	8.01
30	48	1 200	12	8.09
30	54	1 200	10	10.37
30	60	1 200	9	9.77
30	64	1 200	9	12.30
30	70	1 200	9	11.44
30	76	1 200	12	12.22
30	89	1 200	8	14.50
30	102	1 200	4	17.18
30	108	1 200	4	16.90
30	114	1 200	4	19.22
30	133	1 200	4	19.43
30	140	1 200	4	22.13
30	168	1 200	3	32.89
30	219	1 200	2	33.49
30	273	1 200	1	63.78

40	15	1 200	16	7.67
40	18	1 200	16	8.76
40	22	1 200	13	9.03
40	28	1 200	12	8.80
40	35	1 200	10	10.06
40	42	1 200	9	11.45
40	48	1 200	9	11.85
40	54	1 200	7	11.87
40	60	1 200	6	15.65
40	64	1 200	6	15.27
40	70	1 200	8	15.25
40	76	1 200	8	15.57
40	89	1 200	4	17.47
40	102	1 200	4	21.66
40	108	1 200	4	22.59
40	114	1 200	4	21.46
40	133	1 200	4	26.47
40	140	1 200	3	26.73
40	159	1 200	3	
40	168	1 200	3	35.94
40	219	1 200	2	41.76
40	273	1 200	1	84.62

50	15	1 200	10	10.94
50	18	1 200	9	10.75

Izolācijas biezums mm	Čaulas iekšējais diametrs mm	Čaulas garums mm	Gabali iepakojumā	cena par gab
50	22	1 200	9	12.22
50	28	1 200	9	11.60
50	35	1 200	7	13.73
50	42	1 200	6	13.72
50	48	1 200	8	15.53
50	54	1 200	8	15.12
50	60	1 200	5	15.26
50	64	1 200	4	20.06
50	70	1 200	4	19.41
50	76	1 200	4	21.62
50	89	1 200	4	21.72
50	102	1 200	4	26.45
50	108	1 200	4	25.24
50	114	1 200	4	27.23
50	133	1 200	3	37.26
50	140	1 200	3	38.79
50	159	1 200	3	
50	168	1 200	2	40.11
50	194	1 200	2	
50	219	1 200	1	50.32
50	273	1 200	1	108.80

60	22	1 200	6	14.85
60	28	1 200	8	16.38
60	35	1 200	8	16.12
60	42	1 200	4	18.87
60	48	1 200	4	18.61
60	54	1 200	4	20.90
60	60	1 200	4	21.30
60	64	1 200	4	22.45
60	70	1 200	4	25.41
60	76	1 200	8	23.90
60	89	1 200	4	26.39
60	102	1 200	3	30.69
60	108	1 200	3	39.84
60	114	1 200	3	38.04
60	133	1 200	3	36.81
60	140	1 200	3	40.44
60	159	1 200	2	
60	168	1 200	2	42.02
60	219	1 200	1	55.21
60	273	1 200	1	60.24

80	76	1 200	3	42.56
80	89	1 200	3	45.02
80	108	1 200	2	45.80
80	114	1 200	2	50.02
80	133	1 200	2	52.30
80	140	1 200	2	53.86
80	159	1 200	1	
80	168	1 200	1	60.95
80	219	1 200	1	74.56
80	273	1 200	1	81.51

100	108	1 200	1	65.11
100	114	1 200	1	64.26
100	133	1 200	1	74.24
100	140	1 200	1	71.07
100	159	1 200	1	
100	168	1 200	1	77.79
100	273	1 200	1	106.00







## Ventilam ALU Lamella ML-3

### Ventilam ALU Lamella ML-3

Deklarētā īpatnējā siltumvadītspēja	[W/(m·K)] 10°C - 0,039 50°C - 0,047 100°C - 0,060 150°C - 0,077
Maksimālā temperatūra	MST 50°C (EN 14706)
Ugunsdrošības klase	B-s1,d0 - nedegošs materiāls (EN 13501-1).
Biezumapielaides klase	T5
Iepakojums	Polietilēna maiss.

kods	Produkts	Biezums	Izmēri	m <sup>2</sup> /paka	m <sup>2</sup> palete	EUR/pck
Pašlīmējošs minerālvates lamellu paklājs, pārklāts ar alumīnija foliju un pašlīmējošu slāni						
56201	Ventilam ALU Lamella	20	12000/1000/20	12	288	97.03
56203	Ventilam ALU Lamella	30	8000/1000/30	8	240	81.03
	Ventilam ALU Lamella	40	6000/1000/40	6	240	71.90
56207	Ventilam ALU Lamella	50	5000/1000/50	5	180	63.98



Piegades laiks iepriekš saskaņojot  
Piegades laiks iepriekš saskaņojot

## Climcover Lamella ML-3

### Climcover Lamella ML-3

Deklarētā īpatnējā siltumvadītspēja	[W/(m·K)] 0°C - 0,036 50°C - 0,044 100°C - 0,056 150°C - 0,072 200° - 0,091
Maksimālā temperatūra	MST 260°C (EN 14706)
Ugunsdrošības klase	A1 - nedegošs materiāls (EN 13501-1).
Biezumapielaides klase	T4
Ūdens tvaiku pretestības koef	μ~1 EN 12086
Hlorīda joni	CL < 10 mg/kg (EN 13468).
Iepakojums	Polietilēna maiss.
Sertifikāti	CE

kods	Produkts	Biezums	Izmēri	m <sup>2</sup> /paka	m <sup>2</sup> palete	Min EXW	EUR/pck
„G3 touch“ minerālvates lamellu paklājs, pārklāts ar alumīnija foliju. A1 klase							
56280	Climcover Lamella ML-3	20	10 000/1200/20	12	144	1 paka	91.68
56282	Climcover Lamella ML-3	30	8000/1200/30	9.6	115.12	1 paka	85.95
56284	Climcover Lamella ML-3	50	5000/1200/50	6	72	1 paka	75.15
56287	Climcover Lamella ML-3	80	3000/1200/80	3.6	43.2	1 palete	65.77
56289	Climcover Lamella ML-3	100	2500/1200/100	3	36	1 paka	66.24



## Ultimate Protect Wired Mat Alu1 Black Cenrādis 2021

Ugunsdrošs Ultimate vates paklājs, cauršūts ar tērauda sietu, ar melnu alumīnija pārklājumu

Paredzēts ventilācijas konstrukciju ugunsizturības nodrošināšanai līdz EI -120 EN13501-2

Blīvums 66kg/m<sup>3</sup>

Maksimālā temperatūra MST 400°C (EN 14706)

Ugunsreakcijas klase A1 - nedegošs materiāls (EN 13501-1).

Iepakojums Polietilēna maiss.

Sertifikāti CE



kods	Produkts	Biezums mm	Izmēri	m <sup>2</sup> /paka	m <sup>2</sup> paleta	EUR/pck
<b>Ultimate vates paklājs EI ugunsizturības nodrošināšanai</b>						
84433	UPWM 4.0 ALU1 Black	30	30/600/10000	12	216	359.36
84434	UPWM 4.0 ALU1 Black	40	40/600/7500	9	162	323.42
84435	UPWM 4.0 ALU1 Black	50	50/600/6000	7.2	129	302.25
84436	UPWM 4.0 ALU1 Black	60	60/600/5000	6	108	287.65
84437	UPWM 4.0 ALU1 Black	70	70/600/4300	5.16	92.88	278.55
84438	UPWM 4.0 ALU1 Black	75	75/600/4000	4.8	86.4	273.49
84439	UPWM 4.0 ALU1 Black	80	80/600/3700	4.44	79.2	266.39
84440	UPWM 4.0 ALU1 Black	90	90/600/3300	3.96	71.28	261.31
84441	UPWM 4.0 ALU1 Black	100	100/600/3000	3.6	64.8	259.20
84442	UPWM 4.0 ALU1 Black	120	120/600/2500	3	54	251.86

## Ultimate Protect Slab Alu1 Black Cenrādis 2021

Ugunsdrošas Ultimate vates loksnes

Paredzētas ventilācijas konstrukciju ugunsizturības nodrošināšanai līdz EI -120 EN13501-2

Blīvums 67,5kg/m<sup>3</sup>

Maksimālā temperatūra MST 400°C (EN 14706)

Ugunsreakcijas klase A1 - nedegošs materiāls (EN 13501-1).

Iepakojums Polietilēna maiss.

Sertifikāti CE

kods	Produkts	Biezums mm	Izmēri	m <sup>2</sup> /paka	m <sup>2</sup> paleta	EUR/pck
<b>Ultimate Protect vates loksnes EI ugunsizturības nodrošināšanai</b>						
84467	UPS 4.0 ALU1 Black	30	30/600/1200	9.36	112.32	187.45
84468	UPS 4.0 ALU1 Black	40	40/600/1200	7.2	86.4	183.90
84469	UPS 4.0 ALU1 Black	50	50/600/1200	5.76	69.12	179.12
84470	UPS 4.0 ALU1 Black	60	60/600/1200	4.32	51.84	159.95
84471	UPS 4.0 ALU1 Black	70	70/600/1200	3.6	43.2	153.94
84472	UPS 4.0 ALU1 Black	80	80/600/1200	3.6	43.2	171.96
84473	UPS 4.0 ALU1 Black	90	90/600/1200	2.88	34.56	155.17
84474	UPS 4.0 ALU1 Black	100	100/600/1200	2.88	34.56	169.57



AUGSTĀKĀ SILTINĀŠANAS KLASE





## FIREPROTECT 150 cenrādis 2021

Stingras akmensvates loksnes, ugunsdrošības risinājumiem

Bļivums 20mm - 165kg/m<sup>3</sup> 30-100mm 150kg/m<sup>3</sup>

Maksimālā temperatūra MST 700°C (EN 14706)

Kušanas ≥ 1000°C

Ugunsreakcijas klase A1 - nedegošs materiāls (EN 13501-1).

Biezumapielaides tolerance ± 1mm

Udensabsorbciņa WS ≤ 1 kg/m<sup>2</sup> (EN 1609).

Hlorīda joni CL &lt; 10 mg/kg (EN 13468).

Siltumvadītspējas koeficients [W/(m·K)] λ10 °C 0,036

Sertifikāti EN 1365-2:2015 EN 13381-4:2013

## FIREPROTECT 150



kods	Produkts	Biezums mm	Izmēri	m <sup>2</sup> /paka	m <sup>2</sup> paleta	EUR/pck
<b>Akmensvates loksnes augstai termiskajai pretestībai un mehāniskajai slodei 20kPa SSG7591</b>						
56169	FireProtect 150	20	20/600/1200	8.64	86.4	119.98
56179	FireProtect 150	30	30/600/1200	5.04	60.48	89.85
56178	FireProtect 150	50	50/600/1200	2.88	34.56	85.42
56177	FireProtect 150	60	60/600/1200	2.88	28.8	100.68
56174	FireProtect 150	100	100/600/1200	1.44	17.28	81.67

## Climcover Roll CR Alu1

minerālvates paklājs, pārklāts ar pastiprinātu alumīnija foliju,

Deklarētā īpatnējā siltumvadītspēja [W/(m·K)] 10°C - 0,036 50°C - 0,043 100°C - 0,054

Maksimālā temperatūra MST 150°C

Ugunsdrošības klase A1 30-100mm; 20mm A2-s1,d0 - nedegošs materiāls (EN 13501-1).

Iepakojums Polietilēna maiss.

## CLIMCOVER CR1/CR 2 ALU 2



kods	Produkts	Biezums mm	Izmēri	m <sup>2</sup> /paka	m <sup>2</sup> paleta	EUR/pck
<b>Minerālvates paklājs ar pastiprinātu alumīnija pārklājumu, ventilācijas, tvertņu un dažādu virsmu izolēšanai.</b>						
25263	Climcover Roll CR Alu2	20	10000/1200/20	12	n/p	65.06
25274	Climcover Roll CR Alu1	30	8000/1200/40	9.6	n/p	60.00
25309	Climcover Roll CR Alu1	50	7000/1200/50	8.4	n/p	59.85
25408	Climcover Roll CR Alu1	80	5500/1200/60	6.6	n/p	67.81
25444	Climcover Roll CR Alu1	100	4000/1200/70	4.8	n/p	61.14

## Climliner Slab V2 (ex KVL)

Stingras stiklavates loksnes ar melnu filcēcu stiklašķiedras pārklājumu

Paredzētas ventilācijas konstrukciju akustiskajai un siltumizolācijai

Deklarētā īpatnējā siltumvadītspēja [W/(m·K)] 10°C - 0,032 50°C - 0,037 100°C - 0,047

Skaņas absorbciņa α w 15 mm: 0.45; 30 mm 0.70; 50 mm: 1.00; 100 mm: 1.00

Ugunsreakcijas klase A2 (s1; d0) nedegošs materiāls (EN 13501-1).

Iepakojums Polietilēna maiss.

Biezumapielaides klase T3

Maksimālā servisa temperatūra 150°C

## CLIMLINER SLAB V1, V2 pārklātas ar stiklašķiedras audumu



kods	Produkts	Biezums mm	Izmēri	m <sup>2</sup> /paka	m <sup>2</sup> paleta	EUR/pck
<b>ISOVER Climliner Slab V2</b>						
50645	Climliner Slab V2	15	15/1200/1200	14.4	216	105.35
50671	Climliner Slab V2	30	30/1200/1200	8.64	86.4	88.37
30102	Climliner Slab V2	50	50/1200/1200	5.76	57.6	89.34
31133	Climliner Slab V2	100	100/1200/1200	2.88	28.8	73.02
30115	Climliner Slab V2	50	50/1200/3000	6.48	129.60	104.31
30156	Climliner Slab V2	100	100/1200/2400	10.368	103.68	167.16



AUGSTĀKĀ SILTINĀŠANAS KLAŠE





EUR  
VEIKALS

## INSTRUMENTI



EUR  
VEIKALS

921 PPR 733 Šķēres PPR caurulēm 0-42mm, nerūsējošā tērauda asmenis, ar gumiju

14.73 3435001



921 PPR 734 Šķēres PPR caurulēm 0-42mm, nerūsējošā tērauda asmenis

14.46 3435002



913- APAĻŠ

Lodāmurs 1200W (komplektā ar uzgaļiem 16-32mm) Darba t° + 265; jauda- 1200W; 220V. Metāla kaste 47x43x32cm

78.45 7635014



913- PLAKANS

Lodāmurs 1000W (komplektā ar uzgaļiem 20-63mm) GF-825X. Darba t° + 265; jauda- 1000W; 220V. Metāla kaste 47x43x32cm

69.91 7635001



913- APAĻŠ

Lodāmurs 800W (komplektā ar uzgaļiem 16-32mm), GF-834. Darba t° + 265; jauda- 800W; 220V. Metāla kaste 47x43x32cm

73.61 7635020



913- PLAKANS NEW

Lodāmurs 800W (komplektā ar uzgaļiem 20-63mm) Darba t° +50 LĪDZ + 300; jauda- 800W; 220V. Metāla kaste

55.08

7635018



Cauruļu kalibrētājs 16-20

11.45 6435005



Apalā lodāmura uzgaļi 20; 25; 32

8.24 9735006

9.00 9735007

9.81 9735008



922

MINI griezējs caurulēm, 3-22mm

5.95 3435003



923

Cauruļu

9.06 3435004



924

Cauruļu grizējs, 6-50mm

17.44 3435005



1450023

Katlu birste (plakana)

5.83 8235001



331184

PE cauruļu gala frēze

20-63 mm

19.06 2535030



## VEIKALS EUR

<i>Cirkulācijas sūkņi</i>			
Mehāniskais, trīs ātrumi			
		<b>"OHI"</b>	
	OHI 15-60 / 130 bronzas korpus	<b>80.68</b>	7928033
	OHI 15-60 / 130	<b>55.44</b>	7928030
	OHI 25-40 / 180	<b>46.10</b>	7928020
	OHI 25-60 / 130	<b>56.28</b>	7928031
	OHI 25-60 / 130 bronzas korpus	<b>82.80</b>	7928034
	OHI 25-60 / 180	<b>51.41</b>	7928021
	OHI 25-80 / 180	<b>98.76</b>	7928029
	OHI 32-60 / 180	<b>61.21</b>	7928027
	OHI 32-80 / 180	<b>111.75</b>	7928028
<b>Uz pasūtījumu</b>	OHI 40- 80 / 200	<b>141.65</b>	
<b>Uz pasūtījumu</b>	OHI 50-140/220	<b>278.15</b>	
<b>Uz pasūtījumu</b>	OHI 50-170/250	<b>371.78</b>	

## VEIKALS EUR

<i>Cirkulācijas sūkņi</i>			
Elektroniskais, "A" klase			
		<b>"MAGI 2"</b>	
	25-40/180 + fittings	<b>147.53</b>	7928047
	25-60/180 + fittings	<b>158.73</b>	7928043

*Karstā ūdens cirkulācijas sūkņi*

	CPI 15-15	<b>82.58</b>	7928022
--	-----------	--------------	---------

*Karstā ūdens cirkulācijas sūkņi*

	E-IBO 15-14	<b>133.92</b>	7928044
---	-------------	---------------	---------

*Savienojuma komplekts sūkņiem*

	1"	<b>4.11</b>	2124172
	1.1/4"	<b>5.25</b>	2124173

112300

*Savienojuma komplekts sūkņiem*

	1"	<b>4.25</b>	0925308
--	----	-------------	---------

*Cirkulācijas sūkņi*  
Elektroniskais, "A" klase

		<b>"BETA 2"</b>	
	25-40/180 + fittings	<b>107.30</b>	7928026
	25-60/180 + fittings	<b>119.48</b>	7928023
	25-60/130 + fittings	<b>105.05</b>	7928045

*Cirkulācijas sūkņi*  
Elektroniskais, "A" klase

		<b>"OHI PRO"</b>	
	OHI PRO 25-40/180	<b>67.33</b>	7928024
	OHI PRO 25-60/180	<b>68.79</b>	7928025

*Vibrosūkņi*

		<b>"NEMO VM60"</b>	
	VM60 - 3	<b>46.62</b>	7928050

VEIKALS EUR



**Ūdens sūknis RUCESUK-1**  
**34.74 2328003**

**Sūkņa dati:**  
 Maksimālais spiediens 6,0 m  
 Maksimālā ražība 1,5 l/min  
 Sūkņa diametrs 100 mm  
 Sūkņa garums 290 mm  
 Sūkņa svars 3,9 kg  
 Parsūkņejamā ūdens maksimālā temperatūra +35 °C

**Elektriskie dati:**  
 Vienfāzu maiņstrāvas spriegums 220V  
 Pieļaujamās tīkla sprieguma atkāpes no nomināla ±10 %  
 Tīkla frekvence 50 Hz  
 Elektrodzinēja jauda 0,225 kW  
 Strāvas stiprums 1,0 A  
 Elektriskā kabeļa garums 10 metri

VEIKALS EUR



**Iegremdējamais sūknis QDVX 16000**  
**118.52 2328018**

**Sūkņa dati:**  
 Maksimālais spiediens 7,0 m  
 Maksimālais ražīgums (267 l/min) 16 m<sup>3</sup>/h  
 Sūkņa augstums 36 cm  
 Sūkņa diametrs 17 cm  
 Sūkņa svars 6,0 kg

**Elektriskie dati:**  
 Elektrodzinēja absorbētā jauda P1= 0,6 kW  
 Elektrodzinēja nominālā jauda P2=0,37 kW  
 Vienfāzu maiņstrāvas spriegums 230 V  
 Pieļaujamās tīkla sprieguma atkāpes no nomināla ±5 %  
 Tīkla frekvence 50 Hz  
 Strāvas stiprums 2,7 A  
 Elektriskā kabeļa garums 10 metri

Iegremdējamais sūknis QDV 8000



**59.25 2328016**

**Sūkņa dati:**  
 Maksimālais spiediens 5,0 m  
 Sūkņa augstums 30 cm  
 Sūkņa diametrs 17 cm  
 Sūkņa svars 3,9 kg  
 Maksimālais ražīgums (130 l/min) 7,8 m<sup>3</sup>/h

**Elektriskie dati:**  
 Elektrodzinēja absorbētā jauda P1=0,32 kW  
 Elektrodzinēja nominālā jauda P2=0,21 kW  
 Vienfāzu maiņstrāvas spriegums 230 V  
 Pieļaujamās tīkla sprieguma atkāpes no nomināla ±5 %  
 Tīkla frekvence 50 Hz  
 Strāvas stiprums 1,5 A  
 Elektriskā kabeļa garums 10 metri

Ūdens apgādes automāts



**WP INOX - 1000 24H**  
**202.00 2328019**

**Pielietojuma ierobežojumi:**  
 Maksimālā sūkņejamā ūdens temperatūra +35°C,  
 Aizliegts sūkņēt jūras ūdeni, kā arī ķīmiski agresīvus un sprādzienbīstamus šķidrumus.  
 Sūkņi nedrīkst darbināt tukšgaitā bez ūdens.  
 Sūkņis jāstāvē no sala.

**Elektriskie dati:**  
 Elektrodzinēja absorbētā jauda 0,80 kW  
 Elektrodzinēja nominālā jauda 0,55 kW  
 Vienfāzu maiņstrāvas spriegums 230V/50 Hz  
 Aizsardzības klase IP44

**Sūkņa dati:**  
 Maksimālā ražība 55 l/min.  
 Maksimālais spiediens 46 m  
 Maksimālais uzsūkšanas augstums 8 m  
 Sūkņa pievienošanas vītņu izmēri 1”  
 Svārs 12,2 kg

Iegremdējamais sūknis QDV 14000



**76.40 2328017**

**Sūkņa dati:**  
 Maksimālais spiediens 7,0 m  
 Sūkņa augstums 33 cm  
 Sūkņa diametrs 17 cm  
 Sūkņa svars 4,5 kg  
 Maksimālais ražīgums (230 l/min) 14 m<sup>3</sup>/h

**Elektriskie dati:**  
 Elektrodzinēja absorbētā jauda P1= 0,6 kW  
 Elektrodzinēja nominālā jauda P2=0,37 kW  
 Vienfāzu maiņstrāvas spriegums 230 V  
 Pieļaujamās tīkla sprieguma atkāpes no nomināla ±5 %  
 Tīkla frekvence 50 Hz  
 Strāvas stiprums 2,7 A  
 Elektriskā kabeļa garums 10 metri

VEIKALS EUR

VEIKALS EUR

**Ūdens sūknis JSWm 1BN**



<b>247.15</b>	<b>7928001</b>
iesūkšanas augstums ,m	9
Spriegums ,V	220
Jauda ,kW	0.5
Maks. ražība l/min	55
Darba spiediens BAR	1,4 - 2,8

**Ūdens sūknis JSWm 2CX**



<b>269.36</b>	<b>7928002</b>
iesūkšanas augstums ,m	9
Spriegums ,V	220
Jauda ,kW	0.75
Maks. ražība l/min	70
Maks. Spiediens m	47

**Ūdens sūknis JSWm 2AX**



<b>306.85</b>	<b>7928003</b>
iesūkšanas augstums ,m	9
Spriegums ,V	220
Jauda ,kW	1.1
Maks. ražība l/min	70
Maks. Spiediens m	47

**Ūdenssūknis - automāts JSWM 1BN-24CL**



<b>291.58</b>	<b>7928004</b>
iesūkšanas augstums ,m	9
Spriegums ,V	220
Jauda ,kW	0.5
Maks. ražība l/min	55
Darba spiediens BAR	1,4 - 2,8

**Ūdenssūknis - automāts JSWM 2CX-24CL**



<b>342.95</b>	<b>7928005</b>
augstums ,m	9
Spriegums ,V	220
Jauda ,kW	0.75
l/min	70
spiediens	1,4 - 2,8

**Ūdenssūknis - automāts JSWM 2AX-24CL**



<b>392.94</b>	<b>7928006</b>
iesūkšanas augstums ,m	9
Spriegums ,V	220
Jauda ,kW	1.1
Maks. ražība l/min	70
Darba spiediens BAR	2,5 - 4,0

**Membrāna izplešanās traukam**



24 L (80)	<b>15.27</b>	<b>7928007</b>
35/50 L (80)	<b>31.24</b>	<b>7928012</b>
60/80L (80)	<b>47.21</b>	<b>7928015</b>

**Misīņa trejgabals 1"(F-F-M) sūkņiem**



<b>6510G</b>		
1/2"	<b>3.00</b>	<b>0925278</b>
3/4"	<b>4.58</b>	<b>0925279</b>
1"	<b>9.72</b>	<b>0925319</b>

**Spiediena releji**



<b>FSG SQUARE-D</b>	<b>5,4-7,0bar</b>
ar bezūdens aizsardzību	
<b>39.57</b>	<b>7928008</b>



<b>PM/5 ITALTECNICA</b>	<b>1,4-2,8bar</b>
<b>15.98</b>	<b>7928009</b>

Nosaukums	Tilpums L	Art.	Jauda W	Izmēri augst.x plat.x d. mm	Sasildīš. laiks līdz 65°C (Δ50°C)	VEIKALS
-----------	--------------	------	------------	-----------------------------------	--------------------------------------	---------



- ❶ Izmēri (mm)
- ❷ Oļeņķa krūve
- ❸ Pārslāpētā gaisma
- ❹ Magnija anods
- ❺ Sūsiņi
- ❻ Elektriskais sildelements
- ❼ Elektriskais sildelements
- ❽ Elektriskais sildelements
- ❾ Elektriskais sildelements
- ❿ Elektriskais sildelements
- ⓫ Elektriskais sildelements
- ⓬ Elektriskais sildelements
- ⓭ Elektriskais sildelements
- ⓮ Elektriskais sildelements
- ⓯ Elektriskais sildelements
- ⓰ Elektriskais sildelements
- ⓱ Elektriskais sildelements
- ⓲ Elektriskais sildelements
- ⓳ Elektriskais sildelements
- ⓴ Elektriskais sildelements
- ⓵ Elektriskais sildelements
- ⓶ Elektriskais sildelements
- ⓷ Elektriskais sildelements
- ⓸ Elektriskais sildelements
- ⓹ Elektriskais sildelements
- ⓺ Elektriskais sildelements
- ⓻ Elektriskais sildelements
- ⓼ Elektriskais sildelements
- ⓽ Elektriskais sildelements
- ⓿ Elektriskais sildelements
- Ⓚ Elektriskais sildelements
- Ⓛ Elektriskais sildelements
- Ⓜ Elektriskais sildelements
- Ⓨ Elektriskais sildelements
- Ⓩ Elektriskais sildelements



## EXPERT - Sērija

### 5 gadu garantija tvertnei, 2 gadu garantija elektronikai

Ārējais termometrs, cirkonija pārklājums, nerūsējoša izolējoša caurule, magnija anods, augstsprieguma sildelements, ūdens padeves difuzors, "PRO" sistēma, lielblīvuma poliuretāna izolācija 0% CFC, ārējais termoregulators, dielektrisks savienotājs, termostats

Virs izlietnes	10	3000	1600	456 x 255 x 262	24min.	<b>118.69</b>
	15	3001	2000	399 x 338 x 345	35min.	<b>133.10</b>
Zem izlietnes	10	3012	1600	456 x 255 x 262	19min.	<b>120.88</b>
	15	3013	2000	399 x 338 x 345	23min.	<b>133.10</b>
Vertikālie	30	3002	2000	623 x 338 x 345	57 min	<b>144.23</b>
	50	3003	2000	585 x 433 x 451	1st.18 min	<b>169.79</b>
	50	<b>30020</b>	<b>1500</b>	<b>Clacic O'Pro</b>		<b>167.79</b>
	80	3004	2000	814 x 433 x 451	2st.20 min	<b>198.82</b>
	100	3005	2000	973 x 433 x 451	2st.48 min	<b>214.46</b>
	150	3008	1650	505 x 520 x 1241	4st.36 min	<b>321.25</b>
	200	3009	2000	505 x 520 x 1568	5st.50 min	<b>430.15</b>
Horizontāls	80	3006	1500	580 x 809 x 451	2st.38 min	<b>198.31</b>
	100	3007	1500	580 x 968 x 451	3st.36 min	<b>218.43</b>
Grīdas, vertikālais	300	3010	3000	570 x 640 x 1765	5st.33 min	<b>827.61</b>
	500	3011	6000	750 x 850 x 1840	4st.41 min	<b>2058.17</b>

## Sērija STEATITE PRO

### 5 gadu garantija tvertnei, 2 gadu garantija elektronikai

Ārējais termometrs, cirkonija pārklājums, nerūsējoša izejošā caurule, magnija anods, "steatite" keramiskais (sausais) sildelements, ūdens padeves difuzors, emaljēta bāka, lielblīvuma poliuretāna izolācija 0% CFC, ārējais termoregulators, dielektrisks savienotājs, termostats

Vertikālie	50	3020	2100	613 x 433 x 451	1st.22 min	<b>244.16</b>
	80	3021	2100	860 x 433 x 451	2st.12 min	<b>272.30</b>
	100	3022	2100	1022 x 433 x 451	2st.48 min	<b>288.98</b>
	150	3023	1800	505 x 1241	4st.36 min	<b>421.20</b>
	200	3024	2400	505 x 1568	5st.50 min	<b>489.05</b>
Horizontāls	150	3014	2200	1185 x 530	4st.20 min	<b>470.45</b>
	200	3015	2200	1490 x 530	5st.40 min	<b>531.85</b>
Vertikālie grīdas 230/380 V	200	3025	2400	1258 x 575	4st.45 min	<b>1045.65</b>
	300	3026	3000	1761 x 575	5st.46 min	<b>1094.43</b>



Nosaukums	Tilpums L	Art.	Jauda W	Izmēri augst.x plat.x d. mm	Sasildīš. laiks līdz 60°C (Δ50°C)	Sasildīš. laiks ar "BOAST"	VEIKALS
<b>Sērija VERTIGO</b>							
<b>5 gadu garantija tvertnei, 2 gadu garantija elektronikai</b>							
<i>Cirkonija pārklājums tvertnei, nerūsējoša izejošā caurule, "Steatite" keramiskais (sausais) sildelements ar magnija anodu, ūdens padeves difuzors, digitālais displejs, lielblīvuma poliuretāna izolācija 0% CFC</i>							
<i>SMART CONTROL - ieraksta patērētāju ieradumus vienas nedēļas laikā sekojot temperatūrai. Panākot pienācīgu, līdzsvarotu enerģijas taupīšanu.</i>							
<i>SMART CONTROL - ieslēgšanas indikators, ātrā uzsildīšana, "SMART" dušas displejs, manuālais režīms, pretsasalšanas režīms (7°C), manuālā temperatūras regulēšana, "SMART" režīms, režīmu regulators</i>							
Vertikāls / horizontāls	25	3084	1500 + 750	610 x 490 x 290	46 min	30 min	<b>343.02</b>
	40	3081	1500 + 750	765 x 490 x 290	49 min	30 min	<b>392.04</b>
	65	3082	1500 + 750	1090 x 490 x 290	1 st. 19 min.	30 min	<b>532.32</b>
	80	3083	1500 + 750	1300 x 490 x 290	1 st. 38 min.	30 min	<b>557.14</b>



<b>Kombinētie COMBI OPro</b>							
<b>5 gadu garantija tvertnei, 2 gadu garantija elektronikai</b>							
<i>Ārējais termometrs, cirkonija pārklājums, nerūsējoša izejošā caurule, magnija anods, sildelements, ūdens padeves difuzors, O'PRO - pasīvā korpusa aizsardzība, lielblīvuma poliuretāna izolācija 0% CFC, ārējais termoregulators, dielektriskais savienotājs, termostats</i>							
Nosaukums	Tilpums L	Art.	Jauda W	Izmēri mm	Siltummaiņa jauda kW	Ražīgums l/st ***	VEIKALS
Kombinētais	80	3030	1500	451 x 860	12 - 17.5	431	<b>267.85</b>
	100	3031	1500	451 x 1022	12 - 17.5	431	<b>289.61</b>

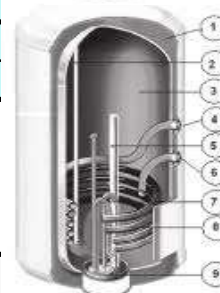



















<b>DUOTHERM</b>							
<b>5 gadu garantija tvertnei, 2 gadu garantija elektronikai</b>							
<i>Koniska siltummaiņa, cirkonija pārklājums, lielblīvuma poliuretāna izolācija 0% CFC (6 cm), nerūsējoša izejošā caurule, ūdens padeves difuzors</i>							
Nosaukums	Tilpums L	Art.	Jauda W	Izmēri mm	Siltummaiņa jauda kW	Ražīgums l/st ***	VEIKALS
Universāls bez elektriska sildelementa	100	3032		567 x 747	11.9 - 18.0	290-444	<b>425.33</b>
	150	3033	2200	567 x 1002	17.5 - 26.0	426-642	<b>649.04</b>
	200	3034	2200	567 x 1257	19.2 - 29.0	468-708	<b>686.06</b>



\*\*\*















Parametri: 90/10/45°C (siltumnesēja temperatūra/temperatūra pie izejas/temperatūra pie ieejas), siltummaiņa ražīgums - 2.0 m3/st









	VEIKALS	EUR	
3200 00	Magnija anods M5 21.3x110	8.30	3768100
		SC/PRO 10-15-30	
3201 00	Magnija anods M8 21.3x660	25.12	3768101
		SG/ 150	
3202 00	Magnija anods M8 21.3x1000	37.71	
		SG/ 200	
3203 00	Magnija anods M8 21.3x550	21.37	
		BDR 100-150	
3204 00	Magnija anods M4 16 x 210	11.01	3768104
		SG/PRO/TI 30	
3205 00	Magnija anods M8 21.3 x 350	19.54	3768312
		TI	
3206 00	Magnija anods M4 13.8 x 150	4.46	3768106
		SG/PRO/ 10-15	
3208 00	Magnija anods M5 25.5 x 230	12.56	3768108
		SG/TI/ PRO R/ 50-80-100	
3275 00	Magnija anods M6, ar kātu 21x290 (21x110)	8.12	3768109
		SG/TI/ PRO R/PRO ECO 50-80-100	

	VEIKALS	EUR	
3209 00	Magnija anods M6 25.5 x 230	12.56	3768110
		SG/TI/ PRO R/ 50-80-100	
3215 00	Sildelements 1200W	33.04	3768112
		SG 100-100-120HT	
3217 00	Sildelements 2.5 kW	32.89	3768309
		SG200	
3220 00	Sildelements 1.5 kW ar flanci	30.15	3768310
		SG/PRO R/ 10-15-30	
3221 00	Sildelements 1800W	49.94	3768118
		PRO R/ PRO ECO 50-80-100	
3222 00	Sildelements 1800W	47.74	
		PRO R/ PRO ECO 50-80-100H	
3223 00	Sildelements 1500W	21.40	3768120
		SG 80-100	
3224 00	Sildelements 1.0 kW ar flanci	45.23	
		VLS 50-80-100	
3225 00	Sildelements 1.5 kW ar flanci	45.23	
		VLS 50-80-100	
3226 00	Sildelements 2.2 kW ar flanci	42.71	
		SG/TI 150	
3227 00	Sildelements 2.5 kW ar flanci	56.54	
		SG/TI 200	

## REZERVES DAĻAS BOILERIEM

	VEIKALS	EUR		VEIKALS	EUR	
3233 00			<i>Sildelements</i>	3251 00		<i>Termoregulators</i>
1200W	<b>21.36</b>	3768130	SG 50-80		<b>18.93</b>	3768147
				SG/PRO R 80-100/80H-100H		
3234 00			<i>Sildelements</i>	3252 00		<i>Termoregulators</i>
1500W	<b>21.36</b>	3768131	SG 100		<b>18.84</b>	3768148
				SG/PRO R/BDRM 80-100-120		
3235 00			<i>Sildelements</i>	3253 00		<i>Termoregulators</i>
1200W	<b>28.47</b>	3768132	SG 80H		<b>46.48</b>	
				SG 10-15		
3236 00			<i>Sildelements</i>	3254 00		<i>Termoregulators</i>
2000W	<b>23.86</b>	3768134	SG 120/ TI 120L		<b>23.88</b>	
				BDR 150-200		
3238 00			<i>Sildelements</i>	3255 00		<i>Termoregulators</i>
2000W	<b>25.12</b>	3768136	SG 80-100TDX		<b>20.11</b>	
				SG 30		
3244 00			<i>Elektronisks termostats</i>	3256 00		<i>Termoregulators</i>
	<b>61.57</b>		PRO ECO 50-80-100		<b>44.87</b>	3768152
				SG/TI 120-200		
3245 00			<i>Elektronisks termostats</i>	3258 00		<i>Termoregulators</i>
	<b>64.08</b>		PRO ECO 50-80-100H		<b>23.88</b>	
				SG/TI 120		
3246 00			<i>Termostats</i>			
			TI SHAPE 50-80-100			
3250 00			<i>Termoregulators</i>			
	<b>18.95</b>	3768314	SG/BDRM 50-80-100			

	VEIKALS	EUR	
	3260 00	<b>23.86</b>	Termoregulators TI SHAPE 50-80-100 3768156
	3261 00	<b>5.01</b>	Blīve flancim BDR/TI 50-100 3768157
	3262 00	<b>5.14</b>	Blīve flancim SG/PRO R/TI 150-200 3768158
	3263 00	<b>3.77</b>	Blīve flancim SG/PRO 10-15-30 3768159
	3264 00	<b>12.76</b>	Flancis ar blīvi SG/PRO R/TI 50-80-100 3768160
	3265 00	<b>7.53</b>	Blīve flancim VLS 50-80-100 3768161
	3274 00	<b>5.62</b>	Blīve flancim PRO R, BLU R PRO ECO (no2013.gada) 3768162
	3299 00 0	<b>1.40</b>	Blīve sildelementam ar vītņi 1800 3766001
	3303 00	<b>1.40</b>	Blīve sildelementam, DUOTHERM VM050-80-100/DUOTHERM/PC10-15-30 (40146) 3766000
	3256 00	<b>33.93</b>	Vadības bloks VLS 50-80-100 3768155
	3267 00	<b>110.58</b>	Vadības bloks VLS PREMIUM/PLUS 50-80-100 3768156
	3268 00	<b>65.34</b>	Barošanas bloks VLS/VLS PREMIUM/PLUS 3768157
	3269 00	<b>23.88</b>	Termometrs 3768158
	3270 00	<b>11.93</b>	Termometrs 3768167
	3272 00	<b>9.43</b>	Signāla lampiņa 3768168

	VEIKALS	EUR	
	3273 00	<b>15.08</b>	Signāla lampiņa 3768169
<b>SILDELEMENTI AR VĪTNI 1.1/4"</b>			
	32931 00	3000kW <b>22.61</b>	Sildelements (Itālija) 3768175
	3294 00	1200W <b>17.58</b>	Sildelements (Itālija) 3768176
	3295 00	1500W <b>17.58</b>	Sildelements (Itālija) 3768177
	3296 00	2000W <b>17.58</b>	Sildelements (Itālija) 3768178
	3297 00	1200W <b>17.58</b>	Sildelements (Itālija) 3768179
	3298 00	1500W <b>17.58</b>	Sildelements (Itālija) 3768180
	3299 00	2000W <b>16.49</b>	Sildelements (Itālija) 3768181

GAB. EUR VEIKALS

GAB. EUR VEIKALS

SNAP		<i>Nerūsējošā tērauda remontskava</i>	
	21-25 (60)	<b>11.53</b>	
	26-30 (60)	<b>11.40</b>	
	33-37 (60)	<b>12.09</b>	
	42-45 (60)	<b>12.30</b>	
	48-51 (60)	<b>13.06</b>	<b>2521047</b>
	55-58(60)	<b>13.70</b>	<b>2521048</b>
	60-64 (60)	<b>13.73</b>	<b>2521049</b>

RS-1		<i>Nerūsējošā tērauda remontskava</i>	
	60-67 (150)	<b>86.17</b>	
	70-77 (150)	<b>87.49</b>	
	76-85 (150)	<b>87.20</b>	
	87-95 (150)	<b>88.34</b>	
	108-118 (150)	<b>97.25</b>	
	159-170 (150)	<b>108.14</b>	
	76-85 (200)	<b>95.88</b>	
	87-95 (200)	<b>96.90</b>	
	95-105 (200)	<b>98.02</b>	
	108-118 (200)	<b>109.16</b>	<b>2527000</b>
	113-123 (200)	<b>109.26</b>	
	159-170 (200)	<b>123.59</b>	
	108-118 (300)	<b>164.33</b>	
	113-123 (300)	<b>166.04</b>	
	159-170 (300)	<b>187.44</b>	

RS-2		<i>Nerūsējošā tērauda remontskava</i>	
	108-128 (200)	<b>167.65</b>	
	158-180 (200)	<b>203.79</b>	
	108-128 (300)	<b>258.36</b>	

3100GE		<i>Bezvītņes pāreja tērauda caurulei</i>	
	1/2"	18	<b>8.80 2521003</b>
	3/4"	18	<b>11.60 2521004</b>
	1"	15	<b>13.95 2521005</b>
	1,1/4"		<b>18.64 2521006</b>
	1,1/2"	8	<b>22.39 2521007</b>
	2"	6	<b>32.84 2521008</b>

3101GE		<i>Bezvītņes pāreja tērauda caurulei</i>	
	1/2"	18	<b>10.06 2521009</b>
	3/4"		<b>11.24 2521010</b>
	1"	15	<b>14.05 2521011</b>
	1,1/4"	10	<b>19.13 2521012</b>
	1,1/2"	8	<b>22.83 2521013</b>
	2"	6	<b>33.80 2521014</b>

3102GE		<i>Bezvītņes uzdeva tērauda caurulei</i>	
	1/2"	18	<b>14.17 2521015</b>
	3/4"	15	<b>17.23 2521016</b>
	1"	15	<b>22.56 2521017</b>
	1,1/4"	10	<b>30.23 2521018</b>
	1,1/2"	8	<b>33.12 2521019</b>
	2"	6	<b>48.54 2521020</b>

3103GE		<i>Bezvītņes trejgabals tērauda caurulei</i>	
	1/2"	18	<b>15.18 2521021</b>
	3/4"	15	<b>20.26 2521022</b>
	1"	15	<b>25.10 2521023</b>
	1,1/4"	10	<b>35.77 2521024</b>
	1,1/2"	8	<b>37.39 2521025</b>
	2"	6	<b>55.10 2521026</b>

3104GE		<i>Bezvītņes remontskava ar atzaru tērauda caurulei</i>	
	1/2"x1/2"	15	<b>9.17 2521037</b>
	3/4"x1/2"	15	<b>10.18 2521038</b>
	1"x1/2"	15	<b>12.12 2521039</b>
	1"x3/4"	15	<b>12.12 2521040</b>
	1,1/4"x3/4"	8	<b>15.97 2521041</b>
	1,1/2"x3/4"	6	<b>18.89 2521042</b>
	2"x1"	4	<b>27.68 2521043</b>

3105GE		<i>Bezvītņes remontskava tērauda caurulei</i>	
	1/2"	18	<b>6.88 2521028</b>
	3/4"	18	<b>7.74 2521029</b>
	1"	8	<b>9.85 2521030</b>
	1,1/4"	10	<b>12.55 2521031</b>
	1,1/2"	6	<b>17.22 2521032</b>
	2"	6	<b>24.22 2521033</b>

GARUMS 3 M		<i>Tērauda caurule, melna</i>	
	DN15(21.3x2.6)	<b>5.24</b>	<b>2532008</b>
	DN20(26.9x2.6)	<b>6.24</b>	<b>2532009</b>
	DN25(33.7x3.2)	<b>11.00</b>	<b>2532010</b>
	DN32(42.3x3.2)	<b>13.61</b>	<b>2532020</b>
	DN40(48.3x3.2)	<b>15.74</b>	<b>2532012</b>
	DN50(60.3x3.2)	<b>19.66</b>	<b>2532013</b>
	DN65(76.1x3.2)	<b>22.71</b>	<b>2532023</b>

GARUMS 3 M		<i>Tērauda caurule, cinkota</i>	
	DN15(21.3x2.6)	<b>5.73</b>	<b>2532025</b>
	DN20(26.9x2.6)	<b>8.21</b>	<b>2532016</b>
	DN25(33.7x3.2)	<b>11.49</b>	<b>2532014</b>
	DN32(42.3x3.2)	<b>13.95</b>	<b>2532015</b>
	DN40(48.3x3.2)	<b>16.86</b>	<b>2532021</b>
	DN50(60.3x3.2)	<b>21.62</b>	<b>2532022</b>



Jauda W	Garums m	80W/m2 papildus	110W/m2 telpas	150W/m2 van. ist.	Ekranizēts divdāzļu kabelis ADSV+, 20 W/m, ar UV izturīgu apvalku	
160	8.3	2.0	1.5	1.0	35.41	8238015
270	14	3.2	2.4	1.7	48.89	8238016
340	17.2	4.0	2.9	2.1	56.44	8238017
450	22.5	5.2	3.8	2.8	68.26	8238018
540	27.4	6.5	4.7	3.5	74.15	8238019
640	32.1	7.5	5.5	4.0	86.63	8238020
720	35.8	8.5	6.2	4.5	96.80	8238021
870	43.8	10.3	7.5	5.5	110.92	8238022
1070	53.5	12.5	9.1	6.6	120.10	8238023
1290	64.4	15.0	10.9	8.0	136.19	8238024
1580	79	18.7	13.6	10.0	157.19	8238025
1850	92.4	21.2	15.4	11.3	168.14	8238026
2300	117.3	27.5	20.0	14.5	217.18	8238027
2750	141.4	32.5	23.6	17.3	275.24	8238028

Apsildes paklāji LDTS – 160W/m2  
solis - 7,6 cm, platums - 50cm  
kabelis ADSV(3,6-4,8 mm) divdāzļu.

Tips	Jauda W	Garums m	lekl.plat. m <sup>2</sup>		
12070-165	70	0.9	0.5	34.38	8238029
12130-165	130	1.6	0.8	38.74	8238030
12210-165	210	2.6	1.3	54.33	8238031
12260-165	260	3.2	1.6	65.67	8238032
12340-165	340	4.2	2.1	82.13	8238033
12410-165	410	5.2	2.6	90.22	8238034
12500-165	500	6.1	3.0	107.86	8238035
12560-165	560	6.7	3.4	116.63	8238036
12670-165	670	8.3	4.2	142.88	8238037
12810-165	810	10.2	5.1	162.71	8238038
121000-165	1000	12.3	6.1	203.31	8238039
121210-165	1210	15.1	7.6	242.36	8238040
121400-165	1400	17.6	8.8	245.15	8238041
121800-165	1800	22.0	11.0	295.36	8238042
122150-165	2150	26.6	13.3	371.29	8238043
122600-165	2600	32.5	16.3	481.62	8238044
<b>Termoregulatori</b>	<b>Jauda(W)</b>	<b>Slodze (A)</b>	<b>Sensors</b>		
UFC 004, analogais	3600	16	Grīdas	38.36	8268004
UFC 001, program.	3600	16	Grīd/Telp	64.44	8268005
UFC E91, progr.skarienjūtīgs	3600	16	Grīd/Telp	82.85	8268006
BEOK 70 EP M/B, progr.skarienjūtīgs	3600	16	Grīd/Telp	138.39	8268007
<b>Piederumi</b>	<b>Gar. (m)</b>	<b>Plat.(m2)</b>			
Montāžas lenta GRUFAST 10m	10	4--5		30.43	8266002
Gofr.caurule sensora ievietošanai 16mm/2m	2			2.52	8238045



Paredzēti ūdensvadu apsildei, kā arī sniega un ledus kausēšanai tehnēs un notekās. Pašregulējošie kabeļi lietojami bez termoregulātora.

Tips	Nosaukums	Garums m	Jauda W	MAGMA KATALOGS	
FSM/ELSR	Pašregulējošais apsildes kabelis 11W/m, komplekts kontakt dakšu, 2m	2	22	<b>51.75</b>	8238001
FSM/ELSR	Pašregulējošais apsildes kabelis 11W/m, komplekts kontakt dakšu, 3m	3	33	<b>64.82</b>	8238002
FSM/ELSR	Pašregulējošais apsildes kabelis 11W/m, komplekts kontakt dakšu, 4m	4	44	<b>77.84</b>	8238003
FSM/ELSR	Pašregulējošais apsildes kabelis 11W/m, komplekts kontakt dakšu, 5m	5	55	<b>90.25</b>	8238004
FSM/ELSR	Pašregulējošais apsildes kabelis 11W/m, komplekts kontakt dakšu, 6m	6	66	<b>103.94</b>	8238005
FSM/ELSR	Pašregulējošais apsildes kabelis 11W/m, komplekts kontakt dakšu, 7m	7	77	<b>116.98</b>	8238006
FSM/ELSR	Pašregulējošais apsildes kabelis 11W/m, komplekts kontakt dakšu, 8m	8	88	<b>130.03</b>	8238007
FSM/ELSR	Pašregulējošais apsildes kabelis 11W/m, komplekts kontakt dakšu, 9m	9	99	<b>143.08</b>	8238008
FSM/ELSR	Pašregulējošais apsildes kabelis 11W/m, komplekts kontakt dakšu, 10m	10	110	<b>156.12</b>	8238009
FSM/ELSR	Pašregulējošais apsildes kabelis 11W/m, komplekts kontakt dakšu, 11m	11	121	<b>169.16</b>	8238010
FSM/ELSR	Pašregulējošais apsildes kabelis 11W/m, komplekts kontakt dakšu, 12m	12	132	<b>182.21</b>	8238011
FSM/ELSR	Pašregulējošais apsildes kabelis 11W/m, spolē metros	--	--	<b>13.05</b>	8238012
	Auksto galu montāža ar materiāliem, 1,5m + kontaktdakša	--	--	<b>25.66</b>	8238013
19805366	Pārejas blīvējums ar vītņi 3/4" un 1" , kabeļa ievadīšanai caurulē DEVI	--	--	<b>31.77</b>	8238014

### Spoguļu apsildes elementi ECOFILM

Tips	Izmērs (mm)	Jauda W	Spriegums V	MAGMA	
MHF 12	274X274	12.5	230	<b>15.14</b>	8279011
MHF 25	274X574	25	230	<b>27.52</b>	8279012
MHF 50	524X524	50	230	<b>38.37</b>	8279013
MHF 100	1024X524	100	230	<b>68.67</b>	8279014

Pašlīmējoša apsildes folija, kas novērš spoguļa svīšanu un nodrošina skaidru redzamību telpās ar paaugstinātu mitrumu.

Vienkārša uzstādīšana - pielīmējiet spoguļa aizmugurē un pievienojiet pie strāvas (rekomendējam pie gaismas slēdža, lai ieslēdzoties gaismai tiek ieslēgta folija).

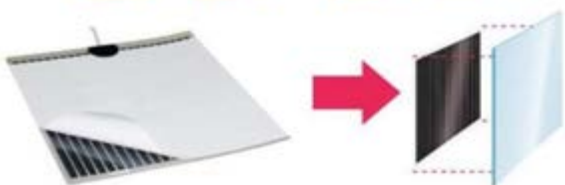

EUR  
VEIKALS

*Roratslēga VIRAX (vanadium)*

10434	30.80	1"	2035002
10449	38.75	1.1/2"	2035003
10460	56.07	2"	2035004



*Universālas knaibles VANADIX VIRAX*

10924	13.96	240	2035005
10930	16.13	300	2035006



*Knaibles VIRAX*

18212	29.17	180	2035007
18218	31.57	250	2035008



*Knaibles-uzgriežņa atslēga 10' 250mm VIRAX*

011210	58.54	250	2035057
--------	-------	-----	---------



*LOCK knaibles VIRAX*

18222	37.42	180	2035009
18228	44.36	250	2035010



*Kapara cauruļu griezējs VIRAX*

210441	27.38	C 28	2035011
--------	-------	------	---------



*Kapara cauruļu griezējs VIRAX*

210443	44.03	ZR35	2035012
210445	50.55	ZR42	2035053



EUR  
VEIKALS

*NT cauruļu griezējs VIRAX*

210475	73.63	C54	2035013
--------	-------	-----	---------



*CU cauruļu griezējs VIRAX*

210447	58.60	C54	2035043
--------	-------	-----	---------

*Plastmasas cauruļu griezējs VIRAX*

215032	26.10	PC32	2035014
--------	-------	------	---------



PVC, PE, PER, PEX caurulēm

~~PPR~~

*Plastmasas cauruļu griezējs VIRAX*

215042	64.15	PC42	2035015
--------	-------	------	---------



PPR; CPVC; PEHD; ABS; PB caurulēm

*Cauruļu griezējs VIRAX MINI*

210439	23.47	28 mm	2035042
--------	-------	-------	---------



Vara caurulei no 3-28 mm

*Plastmasas cauruļu griezējs*

211464	148.57	D63 mm	2035054
--------	--------	--------	---------



PVC, PP, PE, PER, ABS un HDPE caurulēm

~~PPR~~

*Universāla cauruļu galu frēze VIRAX*

221251	69.84	35 mm	2035017
--------	-------	-------	---------

221252	121.55	56 mm	2035046
--------	--------	-------	---------



*Kalibrators VIRAX*

221276	65.74	16x2-20x2-25x2,5-26x3-32x3 mm	2035018
--------	-------	-------------------------------	---------



*Kalibrators VIRAX*

221278	67.19	16x2,25-20x2,5-25x2,5-26x3-32x3 mm	2035019
--------	-------	------------------------------------	---------



EUR  
VEIKALS

EUR  
VEIKALS

	221135	43.80	35	2035045
	221132	47.33	32	2035055

*Profesionāls cauruļu valcētājs*  
3/16 - 1/4 -

250580	131.35	2035047
--------	--------	---------



*Izlietnes teleskopiska atslēga Sanicrom*  
1.3/8"

261450	62.97	2035049
--------	-------	---------



*Izlietnes uzgriežņa atslēga VIRAX*  
1.1/2"

261420	20.06	2035048
--------	-------	---------



*Krāna uzgriežņa atslēga ar rokturi*

261470	39.15	2035050
--------	-------	---------



*Cauruļveida skrūvspīles Etagriff*  
1.1/4" x 3"

200210	196.92	2035041
--------	--------	---------



*Radiatoru atslēga 4 izmēri VIRAX*  
3/8"-1"

220425	71.41	2035016
--------	-------	---------



*Elektriskā rokas prese VIRAX*  
M21

253502	1406.73	2035059
--------	---------	---------



*Elektriskā rokas prese VIRAX*  
ML21

253521	1408.68	2035060
--------	---------	---------



*Tualetes poda atslēga universāla VIRAX*

220510	32.26	2035044
--------	-------	---------



*Asmeņi plastmasas cauruļu griezējam VIRAX*  
PC 40/42

214041	29.85	2035068
--------	-------	---------



*Ieliktnis rokas preseī, karbonam*

990156	284.64	15-18-22	2035081
252955	99.97	28	2035082



*Ieliktnis rokas preseī*

252904	68.25	TH 16	2535061
252907	68.25	TH 20	2535062
252909	68.55	TH 25	2535063
252915	67.92	U 16	2535064
252917	67.92	U 20	2535065
252918	67.56	U 25	2535066



EUR  
VEIKALSEUR  
VEIKALS

 <p><b>2.13</b></p> <p>Gāzes balons 190g ar STOP funkciju EN417-2012</p>	<p>Gāzes balons 190 gr 2035020</p> <p><b>7.16</b></p> <p>Gāzes balons 230gr. Ar 7/16 vītņi-tūristiem un pavāriem</p>  <p>Gāzes balons 230 gr 2035025</p>
 <p><b>5.65</b></p> <p>Prop/but mix gāzes balons 600ml EN417</p>	<p>Gāzes balons 600 ml 2035021</p> <p><b>9.53</b></p> <p>Gāzes balons 500 gr. ar STOP funkciju EN417-2012</p>  <p>Gāzes balons 500 gr 2035026</p>
 <p><b>8.13</b></p> <p>Gāzes balons 450 gr. EN417-2012</p>	<p>Gāzes balons 450 gr 2035022</p> <p><b>29.51</b></p> <p>Gāzes maisījums kas nodrošina 3050 grādu temperatūru</p>  <p>Gāzes balons 610 ml 2035027</p>
 <p><b>4.71</b></p> <p>Šķiltavu gāze ar 5 adapteriem-400ml/220 gr.</p>	<p>Gāzes balons 400 ml 2035023</p> <p><b>32.38</b></p> <p>Gāzes balons ar US vītņi, paredzēts amerikāņu degļiem</p>  <p>Gāzes balons 400 gr 2035028</p>
 <p><b>4.18</b></p> <p>Gāzes balons pavāriem un portatīvajiem degļiem,plītīm</p>	<p>Gāzes balons 227 gr 2035024</p> <p><b>16.47</b></p> <p>Želejveida gāze - darbam jebkurā leņķī,ar temperatūru līdz 2100 grādiem.</p>  <p>Gāzes balons 400 ml 2035029</p>

## INSTRUMENTI

EUR  
VEIKALS

AG384

Deglis ar šļauku Providus  
paredzēts 190 gr baloniem

41.48

2035030



EUR  
VEIKALS

Gāzes deglis ar Piezo aizdedzi, gāzes balonu  
PV900 komplekts Nr.1

30.13

vītne 7/16

400 ml

2035034



PG900

Deglis ar pjezo aizdedzi  
un gāzes padeves regulātoru  
paredzēts 190 gr baloniem

33.52

2035031



GA 200

Deglis  
vītne 7/16

89.92

2035035



AV084 komplekts Nr.1

Deglis ar šļūteni  
vītne 7/16  
ar gāzes balonu  
600 ml

41.92

2035032



AD450

Adapteris degļiem Providus

26.68

2035036



Misiņa deglis ar gāzes balonu  
PV500 komplekts Nr.1

22.90

vītne 7/16  
600 ml

2035033



115050

Portatīvais metināšanas komplekts  
Oxyturbo TURBO SET 90

250.80

2035037



EUR  
VEIKALSEUR  
VEIKALS

<p>WS-36-400 <i>Rūsas pārveidotājs</i></p>  <p><b>7.46</b> 2072005</p> <p>Izcili piemērots sarūsējušu savienojumu, vītņu darba atjaunošanai, samazina berzi, izspiež mitrumu, atvieglo savienojumu montāžu un demontāžu</p>	<p>WS-81-400 <i>Zinc-Alu-Mix Spray</i></p>  <p><b>13.83</b> 2072001</p> <p>Paredzēts šuvju maskēšanai un metināšanas darbiem. Noturīgs pret jebkuriem laika apstākļiem, aizsargā pret rūsas, oksidēšanos.</p>
<p>WS-38-400 <i>Rūsas pārveidotājs SPECIAL</i></p>  <p><b>8.96</b> 2072000</p> <p>Īpašs sastāvs no molibdēna un sintētiskām piedevām - īpaši paredzēts saaugušiem rūsas savienojumiem, kurus nevar atskrūvēt. Ātras iedarbības līdzeklis.</p>	<p>WS-85-400 <i>Zinc Primer Spray-Cinkam</i></p>  <p><b>15.43</b> 2072012</p> <p>Labs pretrūsas līdzeklis, satur - 99% cinka, labi vada elektrību, var maskēt metināšanas šuves. Ātri žūst</p>
<p>WS-40-400 <i>Daudzfunkciju areosols</i></p>  <p><b>10.65</b> 2072007</p> <p>Daudzfunkcionāls līdzeklis savienojumu eļļošanai un aizsardzībai pret rūsas, rūsas noņemšanai, detaļu tīrīšanai. Universāls specializēts līdzeklis ar pretrūsas aizsardzību. COBRA uzgalis</p>	<p>WS-167-400 <i>Chain Guard</i></p>  <p><b>14.10</b> 2072010</p> <p>Ļoti efektīvs pievadķēžu un metāla tauvu aizsarglīdzeklis, smērviela - savienojams ar lielāko daļu eļļu un noturīgs pret mitru, agresīvu vidi. Momentāla iedarbība, pie augstām temperatūrām nenotek. Ļoti ekonomisks - ilgi servisa starposmi.</p>
<p>WS-66-400 <i>Rūsas pārveidotājs Gruntskrāsa</i></p>  <p><b>15.40</b> 2072009</p> <p>3 in 1. Rūsas pārveidotājs, gruntskrāsa un pildviela. Noturīgs pret āra apstākļiem, jūras ūdeni, karstumu, piemērots, alumīnijam, metālam, cinkotām virsmām, betonam, šiferim.</p>	<p>WS-440-400 <i>Anti-Corrosion Wax Spray</i></p>  <p><b>15.57</b> 2072008</p> <p>Pretrūsas ilgstošas aizsardzības vasks. Aizsargā no rūsas rašanās - noturīgs pret ūdeni, ceļu kaisāmo sāli, neļūrumiem, utt. Ideāls līdzeklis instrumentu un augstas precizitātes detaļu konservācijai un aizsardzībai.</p>

DUŠAS KABĪNES

VEIKALS



*Dušas kabīne pusapaļa, komplektā ar akmens masas paliktņi*

80x80x185	FSK21038-80R	<b>435.00</b>	<b>7174017</b>
90x90x185	FSK21038-90R	<b>530.40</b>	<b>7174016</b>

*Dušas kabīne, pusapaļa*

80x80x185	FSE21038-80R	<b>215.00</b>	<b>7174001</b>
90x90x185	FSE21038-90R	<b>215.00</b>	<b>7174000</b>

*Dušas kabīne pusapaļa, komplektā ar akrila paliktņi*

90x90x185	FSK21038-90akr	<b>292.40</b>	<b>7174019</b>
-----------	----------------	---------------	----------------



*Dušas kabīne kvadrāts ar akmens masas dušas paliktņi*

90x90x185	FSK21038-90S	<b>465.00</b>	<b>7174015</b>
-----------	--------------	---------------	----------------

*Dušas kabīne, kvadrāts*

90x90x185	FSE21038-90S	<b>230.00</b>	<b>7174002</b>
-----------	--------------	---------------	----------------

*Dušas durvis FLORY dušas kabīnei, komplekts*

90x90x185	kantaina DOOR90S	<b>81.23</b>	<b>7174007</b>
80x80x185	pusaplis DOOR80R	<b>78.84</b>	<b>7174011</b>
90x90x185	pusaplis DOOR90R	<b>86.50</b>	<b>7174009</b>

*Dušas sienas FLORY dušas kabīni, komplekts*

90x90x185	kantaina SIDE90S	<b>71.46</b>	<b>7174008</b>
80x80x185	pusaplis SIDE80R	<b>53.44</b>	<b>7174012</b>
90x90x185	pusaplis SIDE90R	<b>62.91</b>	<b>7174010</b>

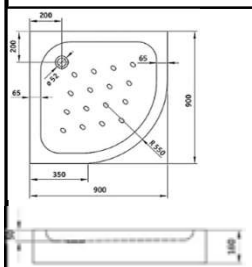

*Dušas paliktņis, pusapaļš akrila*

90x90R **122.10** **8274053**

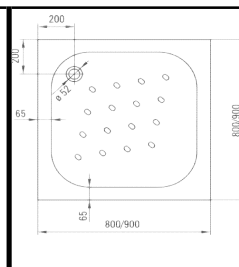

*Dušas paliktņis, kvadrāts akrila*

90x90R **122.10** **8274058**



*Ieteicamais sifons 0205374 vai 0205458*

P 706 / P 708

*Dušas paliktņis, pusapaļš ar kājām un paneli akmens masas*

90x90R **339.27** **7174014**  
80x80R **234.65** **7174018**



Augstums 15 cm  
Biezums 3 cm  
Diametrs 90

*Ieteicamais sifons 0205240*

P 707

*Dušas paliktņis, kvadrāts ar kājām un paneli akmens masas*

90x90 **246.45** **7174013**



Augstums 15 cm  
Biezums 3 cm  
Diametrs 90

*Ieteicamais sifons 0205240*

*Ieteicamais sifons 0205374 vai 0205458*

*Riteņu komplekts duškabīnēm 4 gab*



FSE21038 **14.86** **7174006**

*Blīvgumija alumīnija profilam (2 gab.)*

FSE21038 **5.80** **7174003**

*Gumijas profils stiklam (2 gab.)*

FSE21038 **5.80** **7174004**

*Blīvgumija ar magnētu (2 gab.)*

FSE21038 **25.00** **7174005**