





















































































SATURS







lpp		lpp		lpp		
1		Lokanie pievadi	101		Lodējamie bronzas veidgabali	
7		Magma dušas	102		Kompresijas + presējamie veidgabali (Itālija)	
10		Jaucējkrāni	104		Kompresijas + presējamie (Ķīna)	
31		Jaucējkrāni	105		Čuguna veidgabali	
39		Jaucējkrāni	109		Metināmie veidgabali	
45		Jaucējkrāni	110		PPR veidgabali	
50		Jaucējkrāni	112		KARBONS	
54		Jaucējkrāni	113		PE veidgabali	
56		Dozatori	114		KAS ventīļi	
59		Sensorkrāni	115		Bonomi ventīļi	
61		Ventīļi, kārtidži	117		Noslēgarmatūra	
65		Dušu pievadi	118		WTM ventīļi Hromēti ventīļi	
66		Dušu galvas	119		HERZ	
68		Dušu stieņi	125		Kanplast iekšdarbu kanalizācija	
70		Nicoll sifoni	127		Alphacan ārdarbu kanalizācija	
77		Trapi, noteces	128		Vannas istabas aksesuāri	
81		WC Gofras un veidgabali	133		Batcho izlietnes	
83		WC mehānismi, WC rāmji	138		Aquaphor filtri	
85		Manžetes, skaitītāji	139		Filtri, korpusi	
86		Skrūves, stiprinājumi	141		Dvieļu žāvētāji	
87		Savilcēji, rozetes	146		Elektriskie dvieļu žāvēt.	
88		Blīves	147		Spoguļi	
89		Blīvējumu materiāli	148		Claber virszemes laistīšanas iekārtas	
90		Ķīmija	151		Capricorn Siltās grīdas	
94		Misiņa veidgabali	152		Roku tīrāmie līdzekļi	
99		Kapara veidgabali	153		Feniks iekuri	
				154		Pansa radiatori
				156		Podi, Izlietnes keramiskās
				159		ISOVER Isover čaulas
				163		Instrumenti
				164		IBO sūkņi
				165		Sūkņi Delfin
				166		Sūkņi "Pedrollo"
				167		Boileri "Atlantic"
				169		Rezerves daļas boileriem
				172		GEBO veidgabali
				173		Fenix siltās grīdas
				175		Virax instrumenti (Francija)
				177		Gāzes baloni un degļi
				179		WEKEM WEKEM ķīmija
				180		Dušas kabīnes un paliktņi







701		<i>Lokanais alumīnija pievads ø9x14(1/2"x1/2")</i>					
	FF					FM	
	20	1.98	1061001			20	2.05 1061002
	30	2.13	1061003			30	2.20 1061004
	40	2.28	1061005			40	2.35 1061006
	50	2.40	1061007			50	2.47 1061008
	60	2.55	1061009			60	2.62 1061010
	70	2.75	1061011			70	2.81 1061012
	80	2.93	1061013			80	2.99 1061014
	90	3.06	1061015			90	3.13 1061016
	100	3.24	1061017			100	3.31 1061018
	120	3.69	1061019			120	3.76 1061020
	150	4.32	1061021			150	4.40 1061022
	180	4.83	1061023			180	4.90 1061024
	200	5.34	1061025			200	5.42 1061026
	250	6.53	1061027			250	6.61 1061028
	300	7.59	1061029			300	7.67 1061030
350	8.55	1061031			350	8.63 1061032	
702		<i>Lokanais nerūsējošā tērauda pievads ø9x14(1/2"x1/2")</i>					
	FF					FM	
	20	1.97	1061033			20	2.05 1061034
	30	2.20	1061035			30	2.27 1061036
	40	2.36	1061037			40	2.43 1061038
	50	2.54	1061039			50	2.61 1061040
	60	2.72	1061041			60	2.79 1061042
	70	2.91	1061043			70	2.98 1061044
	80	3.09	1061045			80	3.16 1061046
	90	3.30	1061047			90	3.37 1061048
	100	3.54	1061049			100	3.61 1061050
	120	4.01	1061051			120	4.08 1061052
	150	4.75	1061053			150	4.82 1061054
	180	5.31	1061055			180	5.38 1061056
	200	5.77	1061057			200	5.85 1061058
	250	7.36	1061059			250	7.44 1061060
	300	8.87	1061061			300	8.95 1061062
350	10.27	1061063			350	10.36 1061064	
702/A		<i>Lokanais nerūsējošā tērauda pievads ar blīvēm ø9x14(1/2"x1/2")</i>					
	FF					FM	
	20	2.03	1061246			20	2.17 1061247
	30	2.25	1061248			30	2.38 1061249
	40	2.45	1061250			40	2.58 1061251
	50	2.67	1061252			50	2.79 1061253
	60	2.83	1061254			60	2.96 1061255
	70	3.03	1061256			70	3.15 1061257
	80	3.22	1061258			80	3.34 1061259
	90	3.41	1061260			90	3.53 1061261
	100	3.60	1061262			100	3.73 1061263
	120	4.07	1061264			120	4.19 1061265
	150	4.88	1061266			150	5.00 1061267
	180	5.42	1061268			180	5.54 1061269
	200	5.88	1061270			200	6.00 1061271
	250	7.46	1061272			250	7.59 1061273
	300	8.95	1061274			300	9.09 1061275
350	10.41	1061276			350	10.55 1061277	
712		<i>Lokanais pievads ø8x12(1/2"x1/2")</i>					
	FF	BEZ BLĪVĒM			FM	BEZ BLĪVĒM	
	20	1.72	1061691			20	1.76 1061692
	30	1.89	1061693			30	1.92 1061694
	40	2.03	1061695			40	2.06 1061696
	50	2.15	1061697			50	2.19 1061698
	60	2.29	1061699			60	2.33 1061700
	70	2.46	1061701			70	2.49 1061702
	80	2.66	1061703			80	2.70 1061704
	90	2.89	1061705			90	2.93 1061706
	100	3.06	1061707			100	3.09 1061708
	120	3.53	1061709			120	3.55 1061710
	150	4.22	1061711			150	4.24 1061712
	180	4.85	1061713			180	4.89 1061714
	200	5.06	1061715			200	5.08 1061716
	250	6.20	1061717			250	6.22 1061718
	300	7.41	1061719			300	7.43 1061720
350	8.78	1061721			350	8.80 1061722	











		712/A		<i>Lokanais pievads</i> $\varnothing 8 \times 12(1/2" \times 1/2")$			
		FF	AR BLĪVĒM	FM	AR BLĪVĒM		
		20	1.78	1061550	20	1.80	1061551
		30	1.90	1061552	30	1.94	1061553
		40	2.04	1061554	40	2.06	1061555
		50	2.15	1061556	50	2.17	1061557
		60	2.27	1061558	60	2.32	1061559
		70	2.42	1061560	70	2.45	1061561
		80	2.55	1061562	80	2.60	1061563
		90	2.72	1061564	90	2.74	1061565
		100	2.86	1061566	100	2.88	1061567
		120	3.14	1061568	120	3.17	1061569
		150	3.56	1061570	150	3.58	1061571
		180	3.98	1061572	180	4.03	1061573
		200	4.28	1061574	200	4.31	1061575
		250	5.01	1061576	250	5.04	1061577
300	5.76	1061578	300	5.79	1061579		
350	6.55	1061580	350	6.58	1061581		
708				<i>Lokanais nerūsējošā tērauda pievads</i> $\varnothing 8 \times 12(3/8" \times 3/8")$			
		FF			FM		
		20	2.24	1061214	20	2.22	1061194
		30	2.40	1061215	30	2.42	1061208
		40	2.62	1061216	40	2.61	1061217
		50	2.95	1061193	50	2.96	1061218
		60	3.45	1061219	60	3.39	1061220
		70	3.82	1061221	70	3.82	1061222
		80	4.21	1061223	80	4.22	1061224
		90	4.61	1061225	90	4.57	1061226
		100	4.96	1061227	100	4.96	1061228
707				<i>Lokanais nerūsējošā tērauda pievads</i> $\varnothing 8 \times 12(F1/2" \times M3/8")$			
		FF			FM		
		30	2.70	1061131	30	2.69	1061183
		40	2.93	1061133	40	2.93	1061134
		50	3.15	1061135	50	3.14	1061136
		60	3.36	1061137	60	3.36	1061138
		70	3.63	1061139	70	3.61	1061140
		80	3.85	1061141	80	3.85	1061142
		90	4.12	1061143	90	4.11	1061144
		100	4.34	1061184	100	4.33	1061182
150	5.44	1061282	150	5.44	1061281		
		710		<i>Lokanais nerūsējošā tērauda pievads</i>			
		3/8"Fx$\varnothing 8$		703 1/2"Fx$\varnothing 10$			
		20	2.64	1061229	20	2.39	1061086
		30	2.85	1061230	30	2.67	1061087
		40	3.09	1061210	40	2.88	1061088
		50	3.34	1061231	50	3.12	1061089
		60	3.53	1061232	60	3.34	1061090
		70	3.78	1061233	70	3.62	1061091
		80	4.06	1061234	80	3.83	1061092
		90	4.28	1061235	90	4.09	1061093
		100	4.47	1061236	100	4.33	1061094
709				<i>Lokanais nerūsējošā tērauda pievads ar līkumu</i> $\varnothing 9 \times 14 \times 1/2"$			
				30	3.37	1061195	
				40	3.58	1061196	
				50	3.89	1061197	
				60	4.07	1061198	
				70	4.32	1061201	
				80	4.51	1061199	
				90	4.79	1061211	
				100	5.01	1061200	
		719		<i>Lokanais nerūsējošā tērauda pievads ar līkumu</i>			
		713		$\varnothing 9 \times 14(1/2" \times 3/8")$			
		$\varnothing 9 \times 14(3/8" \times 3/8")$		$\varnothing 9 \times 14(1/2" \times 3/8")$			
		30	3.74	1061510	30	4.05	1061287
		40	3.91	1061511	40	4.20	1061288
		50	4.09	1061512	50	4.36	1061285
		60	4.29	1061513	60	4.55	1061289
		70	4.46	1061514	70	4.70	1061286
		80	4.65	1061515	80	4.89	1061290
90	4.83	1061516	90	5.05	1061291		
100	5.04	1061517	100	5.25	1061292		

704	<i>Lokanie pievadi jaucējkrāniem, nerūsējošā tērauda Ø8x12(10Mx1/2")</i>																									
	<table border="1"> <thead> <tr> <th>LONG</th> <th>SHORT</th> </tr> </thead> <tbody> <tr><td>Ø10x35 2.37 1061595</td><td>Ø10x35 2.05 1061065</td></tr> <tr><td>Ø10x40 2.55 1061596</td><td>Ø10x40 2.23 1061179</td></tr> <tr><td>Ø10x45 2.67 1061597</td><td>Ø10x45 2.35 1061180</td></tr> <tr><td>Ø10x50 2.75 1061598</td><td>Ø10x50 2.41 1061066</td></tr> <tr><td>Ø10x60 3.04 1061599</td><td>Ø10x60 2.73 1061181</td></tr> <tr><td>Ø10x70 3.31 1061600</td><td>Ø10x70 2.99 1061067</td></tr> <tr><td>Ø10x80 3.49 1061601</td><td>Ø10x80 3.17 1061068</td></tr> <tr><td>Ø10x90 3.81 1061602</td><td>Ø10x90 3.50 1061069</td></tr> <tr><td>Ø10x100 4.01 1061603</td><td>Ø10x100 3.69 1061070</td></tr> <tr><td>Ø10x120 4.56 1061604</td><td>Ø10x120 4.24 1061073</td></tr> <tr><td>Ø10x150 5.44 1061605</td><td>Ø10x150 5.12 1061074</td></tr> </tbody> </table>	LONG	SHORT	Ø10x35 2.37 1061595	Ø10x35 2.05 1061065	Ø10x40 2.55 1061596	Ø10x40 2.23 1061179	Ø10x45 2.67 1061597	Ø10x45 2.35 1061180	Ø10x50 2.75 1061598	Ø10x50 2.41 1061066	Ø10x60 3.04 1061599	Ø10x60 2.73 1061181	Ø10x70 3.31 1061600	Ø10x70 2.99 1061067	Ø10x80 3.49 1061601	Ø10x80 3.17 1061068	Ø10x90 3.81 1061602	Ø10x90 3.50 1061069	Ø10x100 4.01 1061603	Ø10x100 3.69 1061070	Ø10x120 4.56 1061604	Ø10x120 4.24 1061073	Ø10x150 5.44 1061605	Ø10x150 5.12 1061074	
LONG	SHORT																									
Ø10x35 2.37 1061595	Ø10x35 2.05 1061065																									
Ø10x40 2.55 1061596	Ø10x40 2.23 1061179																									
Ø10x45 2.67 1061597	Ø10x45 2.35 1061180																									
Ø10x50 2.75 1061598	Ø10x50 2.41 1061066																									
Ø10x60 3.04 1061599	Ø10x60 2.73 1061181																									
Ø10x70 3.31 1061600	Ø10x70 2.99 1061067																									
Ø10x80 3.49 1061601	Ø10x80 3.17 1061068																									
Ø10x90 3.81 1061602	Ø10x90 3.50 1061069																									
Ø10x100 4.01 1061603	Ø10x100 3.69 1061070																									
Ø10x120 4.56 1061604	Ø10x120 4.24 1061073																									
Ø10x150 5.44 1061605	Ø10x150 5.12 1061074																									
	<i>Lokanie pievadi jaucējkrāniem, nerūsējošā tērauda Ø8x12(12Mx1/2")</i>																									
		<table border="1"> <tbody> <tr><td>Ø12x35 2.26 1061121</td></tr> <tr><td>Ø12x50 2.64 1061122</td></tr> <tr><td>Ø12x70 3.12 1061123</td></tr> <tr><td>Ø12x80 3.39 1061124</td></tr> <tr><td>Ø12x90 3.59 1061125</td></tr> <tr><td>Ø12x100 3.86 1061126</td></tr> <tr><td>Ø12x120 4.18 1061127</td></tr> <tr><td>Ø12x150 4.88 1061128</td></tr> </tbody> </table>	Ø12x35 2.26 1061121	Ø12x50 2.64 1061122	Ø12x70 3.12 1061123	Ø12x80 3.39 1061124	Ø12x90 3.59 1061125	Ø12x100 3.86 1061126	Ø12x120 4.18 1061127	Ø12x150 4.88 1061128																
Ø12x35 2.26 1061121																										
Ø12x50 2.64 1061122																										
Ø12x70 3.12 1061123																										
Ø12x80 3.39 1061124																										
Ø12x90 3.59 1061125																										
Ø12x100 3.86 1061126																										
Ø12x120 4.18 1061127																										
Ø12x150 4.88 1061128																										
704/G	<i>Lokanie pievadi jaucējkrāniem, nerūsējošā tērauda Ø8x12(10Mx1/2") (90 mm)</i>																									
		<table border="1"> <tbody> <tr><td>Ø10x35 4.77 1061172</td></tr> <tr><td>Ø10x50 5.65 1061363</td></tr> </tbody> </table>	Ø10x35 4.77 1061172	Ø10x50 5.65 1061363																						
Ø10x35 4.77 1061172																										
Ø10x50 5.65 1061363																										
704/1	<i>Lokanais pievadi jaucējkrāniem, nerūsējošā tērauda Ø8x12(10Mx3/8")</i>																									
	<table border="1"> <tbody> <tr><td>Ø10x35 2.62 1061606</td></tr> <tr><td>Ø10x45 3.26 1061607</td></tr> <tr><td>Ø10x50 3.20 1061608</td></tr> <tr><td>Ø10x70 3.95 1061609</td></tr> <tr><td>Ø10x80 4.05 1061610</td></tr> <tr><td>Ø10x100 4.43 1061611</td></tr> </tbody> </table>	Ø10x35 2.62 1061606	Ø10x45 3.26 1061607	Ø10x50 3.20 1061608	Ø10x70 3.95 1061609	Ø10x80 4.05 1061610	Ø10x100 4.43 1061611	<table border="1"> <tbody> <tr><td>Ø10x35 2.34 1061185</td></tr> <tr><td>Ø10x45 3.00 1061360</td></tr> <tr><td>Ø10x50 2.92 1061171</td></tr> <tr><td>Ø10x70 3.68 1061293</td></tr> <tr><td>Ø10x80 3.77 1061209</td></tr> <tr><td>Ø10x100 4.14 1061280</td></tr> </tbody> </table>	Ø10x35 2.34 1061185	Ø10x45 3.00 1061360	Ø10x50 2.92 1061171	Ø10x70 3.68 1061293	Ø10x80 3.77 1061209	Ø10x100 4.14 1061280												
Ø10x35 2.62 1061606																										
Ø10x45 3.26 1061607																										
Ø10x50 3.20 1061608																										
Ø10x70 3.95 1061609																										
Ø10x80 4.05 1061610																										
Ø10x100 4.43 1061611																										
Ø10x35 2.34 1061185																										
Ø10x45 3.00 1061360																										
Ø10x50 2.92 1061171																										
Ø10x70 3.68 1061293																										
Ø10x80 3.77 1061209																										
Ø10x100 4.14 1061280																										
724	<i>Lokanie pievadi jaucējkrāniem, nerūsējošā tērauda Ø8x12(10Mx1/2") iekšējās caurules materiāls PEX-B</i>																									
	<table border="1"> <thead> <tr> <th>LONG</th> <th>SHORT</th> </tr> </thead> <tbody> <tr><td>Ø10x35 2.47 1061653</td><td>Ø10x35 2.13 1061641</td></tr> <tr><td>Ø10x40 2.62 1061654</td><td>Ø10x40 2.30 1061642</td></tr> <tr><td>Ø10x45 2.75 1061655</td><td>Ø10x45 2.43 1061643</td></tr> <tr><td>Ø10x50 2.80 1061656</td><td>Ø10x50 2.51 1061644</td></tr> <tr><td>Ø10x60 3.11 1061657</td><td>Ø10x60 2.80 1061645</td></tr> <tr><td>Ø10x70 3.35 1061658</td><td>Ø10x70 3.04 1061646</td></tr> <tr><td>Ø10x80 3.51 1061659</td><td>Ø10x80 3.21 1061647</td></tr> <tr><td>Ø10x90 3.83 1061660</td><td>Ø10x90 3.52 1064648</td></tr> <tr><td>Ø10x100 4.03 1061661</td><td>Ø10x100 3.72 1061649</td></tr> <tr><td>Ø10x120 4.56 1061662</td><td>Ø10x120 4.24 1061650</td></tr> <tr><td>Ø10x150 5.38 1061663</td><td>Ø10x150 5.08 1061651</td></tr> </tbody> </table>	LONG	SHORT	Ø10x35 2.47 1061653	Ø10x35 2.13 1061641	Ø10x40 2.62 1061654	Ø10x40 2.30 1061642	Ø10x45 2.75 1061655	Ø10x45 2.43 1061643	Ø10x50 2.80 1061656	Ø10x50 2.51 1061644	Ø10x60 3.11 1061657	Ø10x60 2.80 1061645	Ø10x70 3.35 1061658	Ø10x70 3.04 1061646	Ø10x80 3.51 1061659	Ø10x80 3.21 1061647	Ø10x90 3.83 1061660	Ø10x90 3.52 1064648	Ø10x100 4.03 1061661	Ø10x100 3.72 1061649	Ø10x120 4.56 1061662	Ø10x120 4.24 1061650	Ø10x150 5.38 1061663	Ø10x150 5.08 1061651	
LONG	SHORT																									
Ø10x35 2.47 1061653	Ø10x35 2.13 1061641																									
Ø10x40 2.62 1061654	Ø10x40 2.30 1061642																									
Ø10x45 2.75 1061655	Ø10x45 2.43 1061643																									
Ø10x50 2.80 1061656	Ø10x50 2.51 1061644																									
Ø10x60 3.11 1061657	Ø10x60 2.80 1061645																									
Ø10x70 3.35 1061658	Ø10x70 3.04 1061646																									
Ø10x80 3.51 1061659	Ø10x80 3.21 1061647																									
Ø10x90 3.83 1061660	Ø10x90 3.52 1064648																									
Ø10x100 4.03 1061661	Ø10x100 3.72 1061649																									
Ø10x120 4.56 1061662	Ø10x120 4.24 1061650																									
Ø10x150 5.38 1061663	Ø10x150 5.08 1061651																									
724/1	<i>Lokanais pievadi jaucējkrāniem, nerūsējošā tērauda Ø8x12(10Mx3/8") iekšējās caurules materiāls PEX-B</i>																									
	<table border="1"> <thead> <tr> <th>LONG</th> <th>SHORT</th> </tr> </thead> <tbody> <tr><td>Ø10x35 3.07 1061670</td><td>Ø10x35 2.71 1061664</td></tr> <tr><td>Ø10x45 3.23 1061671</td><td>Ø10x45 3.06 1061665</td></tr> <tr><td>Ø10x50 3.52 1061672</td><td>Ø10x50 3.30 1061666</td></tr> <tr><td>Ø10x70 4.26 1061673</td><td>Ø10x70 4.01 1061667</td></tr> <tr><td>Ø10x80 4.32 1061674</td><td>Ø10x80 4.09 1061668</td></tr> <tr><td>Ø10x100</td><td>Ø10x100 4.41 1061669</td></tr> </tbody> </table>	LONG	SHORT	Ø10x35 3.07 1061670	Ø10x35 2.71 1061664	Ø10x45 3.23 1061671	Ø10x45 3.06 1061665	Ø10x50 3.52 1061672	Ø10x50 3.30 1061666	Ø10x70 4.26 1061673	Ø10x70 4.01 1061667	Ø10x80 4.32 1061674	Ø10x80 4.09 1061668	Ø10x100	Ø10x100 4.41 1061669											
LONG	SHORT																									
Ø10x35 3.07 1061670	Ø10x35 2.71 1061664																									
Ø10x45 3.23 1061671	Ø10x45 3.06 1061665																									
Ø10x50 3.52 1061672	Ø10x50 3.30 1061666																									
Ø10x70 4.26 1061673	Ø10x70 4.01 1061667																									
Ø10x80 4.32 1061674	Ø10x80 4.09 1061668																									
Ø10x100	Ø10x100 4.41 1061669																									
724/G	<i>Lokanie pievadi jaucējkrāniem, nerūsējošā tērauda Ø8x12(10Mx1/2") (90 mm) iekšējās caurules materiāls PEX-B</i>																									
		<table border="1"> <tbody> <tr><td>Ø10x35 4.80 1061675</td></tr> <tr><td>Ø10x50 5.64 1061676</td></tr> </tbody> </table>	Ø10x35 4.80 1061675	Ø10x50 5.64 1061676																						
Ø10x35 4.80 1061675																										
Ø10x50 5.64 1061676																										

VEIKALS

706		Lokanie nerūsējošā tērauda pievadi gāzei (1/2"x1/2")					
		FF			FM		
	50	4.86	1061109	50	4.86	1061110	
	80	5.48	1061111	80	5.48	1061112	
	100	6.01	1061113	100	6.01	1061114	
	120	6.68	1061115	120	6.68	1061116	
	150	7.62	1061117	150	7.62	1061118	
	200	9.18	1061119	200	9.18	1061120	
714		Lokanais nerūsējošā tērauda pievads Ø13x18					
		FF			FM		
	1/2"x200	3.89	1061400	1/2"x200	3.55	1061401	
	1/2"x300	4.31	1061402	1/2"x300	3.96	1061403	
	1/2"x400	4.72	1061404	1/2"x400	4.38	1061405	
	1/2"x500	5.13	1061406	1/2"x500	4.79	1061407	
	1/2"x600	5.54	1061408	1/2"x600	5.21	1061409	
	1/2"x700	5.95	1061410	1/2"x700	5.62	1061411	
	1/2"x800	6.37	1061412	1/2"x800	6.04	1061413	
	1/2"x900	6.78	1061414	1/2"x900	6.46	1061415	
	1/2"x1000	7.21	1061416	1/2"x1000	6.88	1061417	
	715		Lokanais nerūsējošā tērauda pievads Ø13x18				
		FF			FM		
	3/4"x200	6.35	1061430	3/4"x200	5.96	1061431	
	3/4"x300	6.77	1061432	3/4"x300	6.38	1061433	
	3/4"x400	7.18	1061434	3/4"x400	6.80	1061435	
	3/4"x500	7.61	1061436	3/4"x500	7.21	1061437	
	3/4"x600	8.02	1061438	3/4"x600	7.63	1061439	
	3/4"x700	8.44	1061440	3/4"x700	8.04	1061441	
	3/4"x800	8.85	1061442	3/4"x800	8.46	1061443	
	3/4"x900	9.27	1061444	3/4"x900	8.87	1061445	
	3/4"x1000	9.68	1061446	3/4"x1000	9.29	1061447	
	716		Lokanais nerūsējošā tērauda pievads ar līkumu Ø13x18				
		FF			FM		
	1/2"x300	7.53	1061460	1/2"x300	7.53	1061460	
	1/2"x400	7.94	1061461	1/2"x400	7.94	1061461	
	1/2"x500	8.37	1061462	1/2"x500	8.37	1061462	
	1/2"x600	8.78	1061463	1/2"x600	8.78	1061463	
	1/2"x700	9.19	1061464	1/2"x700	9.19	1061464	
	1/2"x800	9.61	1061465	1/2"x800	9.61	1061465	
	1/2"x900	10.02	1061466	1/2"x900	10.02	1061466	
	1/2"x1000	10.43	1061467	1/2"x1000	10.43	1061467	
	1/2"x1200	11.27	1061468	1/2"x1200	11.27	1061468	
1/2"x1500	12.51	1061469	1/2"x1500	12.51	1061469		
717		Lokanais nerūsējošā tērauda pievads ar līkumu Ø13x18					
		FF			FM		
	3/4"x300	9.77	1061471	3/4"x300	9.77	1061471	
	3/4"x400	10.20	1061472	3/4"x400	10.20	1061472	
	3/4"x500	10.61	1061473	3/4"x500	10.61	1061473	
	3/4"x600	11.03	1061474	3/4"x600	11.03	1061474	
	3/4"x700	11.44	1061475	3/4"x700	11.44	1061475	
	3/4"x800	11.86	1061476	3/4"x800	11.86	1061476	
	3/4"x900	12.27	1061477	3/4"x900	12.27	1061477	
	3/4"x1000	12.69	1061478	3/4"x1000	12.69	1061478	
	3/4"x1200	13.53	1061479	3/4"x1200	13.53	1061479	
3/4"x1500	14.77	1061480	3/4"x1500	14.77	1061480		
718		Lokanais nerūsējošā tērauda pievads ar līkumu Ø13x18					
		FF			FM		
	1/2"F x 3/4"F	1061492	9.48	1/2"M x 3/4"F	300	8.27	1061483
	1/2"F x 3/4"F	1061493	9.94	1/2"M x 3/4"F	400	8.68	1061484
	1/2"F x 3/4"F	1061494	10.41	1/2"M x 3/4"F	500	9.11	1061485
	1/2"F x 3/4"F			1/2"M x 3/4"F	600	9.55	1061617
	1/2"F x 3/4"F	1061731	11.37	1/2"M x 3/4"F	700	11.66	1061745
	1/2"F x 3/4"F			1/2"M x 3/4"F	800	10.36	1061488
	1/2"F x 3/4"F			1/2"M x 3/4"F	900		
	1/2"F x 3/4"F			1/2"M x 3/4"F	1000	11.17	1061688

	TF					<i>Antivibrācijas lokanie pievadi</i>			
	3/4"x200	4.68	1061095	1"x300	7.96	1061154			
	3/4"x300	5.22	1061096	1"x400	8.21	1061155			
	3/4"x400	5.77	1061097	1"x500	8.55	1061156			
	3/4"x500	6.32	1061098	1"x600	9.14	1061157			
	3/4"x600	6.88	1061099	1"x700	9.77	1061158			
	3/4"x700	7.44	1061100	1"x800	10.60	1061190			
	3/4"x800	8.00	1061101	1"x900	10.91	1061159			
	3/4"x900	8.56	1061102	1"x1000	11.77	1061160			
	3/4"x1000	9.19	1061103	1"x1200	15.70	1061245			
	3/4"x1200	13.24	1061243	1"x1500	18.04	1061240			
	3/4"x1500	15.31	1061241						
	TFF					<i>Antivibrācijas lokanie pievadi</i>			
	3/4"x300	6.20	1061542	1"x300	8.90	1061279			
	3/4"x400	6.52	1061212	1"x400	9.52	1061207			
	3/4"x500	7.07	1061173	1"x500	10.14	1061178			
	3/4"x600	7.63	1061206	1"x600	10.76	1061191			
	3/4"x700	8.20	1061174	1"x700	11.39	1061177			
	3/4"x800	8.76	1061205	1"x800	12.03	1061192			
	3/4"x900	9.34	1061634	1"x900	12.67	1061189			
	3/4"x1000	9.92	1061175	1"x1000	13.32	1061170			
	3/4"x1200	11.66	1061635	1"x1200	16.39	1061296			
		TFG					<i>Antivibrācijas lokanie pievadi ar līkumu</i>		
3/4"x300		6.77	1061147	1"x300	8.55	1061161			
3/4"x400		7.19	1061148	1"x400	9.03	1061162			
3/4"x500		7.58	1061149	1"x500	9.52	1061163			
3/4"x600		8.06	1061150	1"x600	9.89	1061164			
3/4"x700		8.55	1061151	1"x700	10.32	1061165			
3/4"x800		9.09	1061213	1"x800	10.83	1061202			
3/4"x900		9.60	1061152	1"x900	11.21	1061166			
3/4"x1000		9.92	1061153	1"x1000	11.58	1061167			
				1"x1200	17.21	1061297			
		TFFG					<i>Antivibrācijas lokanie pievadi ar līkumu</i>		
	3/4"x500	9.44	1061347	1"x500	13.36	1061238			
	3/4"x600	9.92	1061244	1"x600	13.89	1061298			
	3/4"x700	10.30	1061545	1"x700	14.42	1061239			
	3/4"x800	10.90	1061283	1"x800	16.58	1061547			
	3/4"x900			1"x900	17.40	1061734			
	3/4"x1000	11.90	1061294	1"x1000	18.12	1061540			
		TFN					<i>Antivibrācijas lokanie pievadi, nerūsējošais tērauds</i>		
3/4"x200		4.96	1061312	1"x300	8.03	1061145			
3/4"x300		5.67	1061313	1"x400	8.64	1061146			
3/4"x400		6.39	1061314	1"x500	9.26	1061176			
3/4"x500		7.12	1061315	1"x600	9.90	1061299			
3/4"x600		7.86	1061316	1"x700	10.53	1061300			
3/4"x700		8.61	1061317	1"x800	11.17	1061301			
3/4"x800		9.35	1061318	1"x900	11.81	1061302			
3/4"x900		10.12	1061319	1"x1000	12.47	1061129			
3/4"x1000		10.87	1061320	1"x1200	15.17	1061130			
				1"x1500	17.95	1061132			
	TFFN					<i>Antivibrācijas lokanie pievadi, nerūsējošais tērauds</i>			
	3/4"x300	6.42	1061331	1"x300	8.85	1061330			
	3/4"x400	7.14	1061333	1"x400	9.44	1061332			
	3/4"x500	7.87	1061335	1"x500	10.05	1061334			
	3/4"x600	8.62	1061337	1"x600	10.67	1061336			
	3/4"x700	9.37	1061339	1"x700	11.30	1061338			
	3/4"x800	10.13	1061341	1"x800	11.93	1061340			
	3/4"x900	10.89	1061343	1"x900	12.57	1061342			
	3/4"x1000	11.66	1061345	1"x1000	13.23	1061344			
		TFGN					<i>Antivibrācijas lokanie pievadi ar līkumu (nerūsējošā tērauda)</i>		
3/4"x300		11.10	1061321	1"x300	14.41	1061303			
3/4"x400		11.92	1061322	1"x400	15.12	1061304			
3/4"x500		12.75	1061323	1"x500	15.85	1061305			
3/4"x600		13.59	1061324	1"x600	16.56	1061306			
3/4"x700		14.43	1061325	1"x700	17.31	1061307			
3/4"x800		15.29	1061326	1"x800	18.04	1061308			
3/4"x900		16.15	1061327	1"x900	18.80	1061309			
3/4"x1000		17.01	1061328	1"x1000	19.54	1061310			
3/4"x1200		20.66	1061329	1"x1200	23.18	1061311			

<p>TFFGN</p> 	<p><i>Antivibrācijas lokanie pievadi ar līkumu (nerūsējošā tērauda)</i></p> <table border="1"> <tr><td>3/4"x300</td><td>11.85</td><td>1061365</td><td>1"x300</td><td>15.08</td><td>1061374</td></tr> <tr><td>3/4"x400</td><td>12.70</td><td>1061366</td><td>1"x400</td><td>15.81</td><td>1061375</td></tr> <tr><td>3/4"x500</td><td>13.54</td><td>1061367</td><td>1"x500</td><td>16.53</td><td>1061376</td></tr> <tr><td>3/4"x600</td><td>14.38</td><td>1061368</td><td>1"x600</td><td>17.26</td><td>1061377</td></tr> <tr><td>3/4"x700</td><td>15.24</td><td>1061369</td><td>1"x700</td><td>18.00</td><td>1061378</td></tr> <tr><td>3/4"x800</td><td>16.10</td><td>1061370</td><td>1"x800</td><td>18.74</td><td>1061379</td></tr> <tr><td>3/4"x900</td><td>16.97</td><td>1061371</td><td>1"x900</td><td>19.49</td><td>1061380</td></tr> <tr><td>3/4"x1000</td><td>17.85</td><td>1061372</td><td>1"x1000</td><td>20.25</td><td>1061381</td></tr> <tr><td>3/4"x1200</td><td>21.60</td><td>1061373</td><td>1"x1200</td><td>23.97</td><td>1061382</td></tr> </table>	3/4"x300	11.85	1061365	1"x300	15.08	1061374	3/4"x400	12.70	1061366	1"x400	15.81	1061375	3/4"x500	13.54	1061367	1"x500	16.53	1061376	3/4"x600	14.38	1061368	1"x600	17.26	1061377	3/4"x700	15.24	1061369	1"x700	18.00	1061378	3/4"x800	16.10	1061370	1"x800	18.74	1061379	3/4"x900	16.97	1061371	1"x900	19.49	1061380	3/4"x1000	17.85	1061372	1"x1000	20.25	1061381	3/4"x1200	21.60	1061373	1"x1200	23.97	1061382
3/4"x300	11.85	1061365	1"x300	15.08	1061374																																																		
3/4"x400	12.70	1061366	1"x400	15.81	1061375																																																		
3/4"x500	13.54	1061367	1"x500	16.53	1061376																																																		
3/4"x600	14.38	1061368	1"x600	17.26	1061377																																																		
3/4"x700	15.24	1061369	1"x700	18.00	1061378																																																		
3/4"x800	16.10	1061370	1"x800	18.74	1061379																																																		
3/4"x900	16.97	1061371	1"x900	19.49	1061380																																																		
3/4"x1000	17.85	1061372	1"x1000	20.25	1061381																																																		
3/4"x1200	21.60	1061373	1"x1200	23.97	1061382																																																		
<p>341/A</p> 	<p><i>Ieplūdes pievadi veļas mašīnām (PVC)</i></p> <table border="1"> <tr><td>3/4"x150</td><td>3.06</td><td>1061104</td></tr> <tr><td>3/4"x200</td><td>3.76</td><td>1061105</td></tr> <tr><td>3/4"x250</td><td>4.31</td><td>1061106</td></tr> <tr><td>3/4"x300</td><td>4.99</td><td>1061107</td></tr> <tr><td>3/4"x400</td><td>6.35</td><td>1061108</td></tr> </table>	3/4"x150	3.06	1061104	3/4"x200	3.76	1061105	3/4"x250	4.31	1061106	3/4"x300	4.99	1061107	3/4"x400	6.35	1061108																																							
3/4"x150	3.06	1061104																																																					
3/4"x200	3.76	1061105																																																					
3/4"x250	4.31	1061106																																																					
3/4"x300	4.99	1061107																																																					
3/4"x400	6.35	1061108																																																					
<p>341</p> 	<p><i>Ieplūdes pievadi veļas mašīnām ar līkumu (PVC)</i></p> <table border="1"> <tr><td>3/4"x100</td><td>2.87</td><td>1061295</td></tr> <tr><td>3/4"x150</td><td>3.12</td><td>1061080</td></tr> <tr><td>3/4"x200</td><td>3.78</td><td>1061081</td></tr> <tr><td>3/4"x250</td><td>4.35</td><td>1061082</td></tr> <tr><td>3/4"x300</td><td>5.04</td><td>1061083</td></tr> <tr><td>3/4"x400</td><td>6.43</td><td>1061084</td></tr> <tr><td>3/4"x500</td><td>8.47</td><td>1061186</td></tr> </table>	3/4"x100	2.87	1061295	3/4"x150	3.12	1061080	3/4"x200	3.78	1061081	3/4"x250	4.35	1061082	3/4"x300	5.04	1061083	3/4"x400	6.43	1061084	3/4"x500	8.47	1061186																																	
3/4"x100	2.87	1061295																																																					
3/4"x150	3.12	1061080																																																					
3/4"x200	3.78	1061081																																																					
3/4"x250	4.35	1061082																																																					
3/4"x300	5.04	1061083																																																					
3/4"x400	6.43	1061084																																																					
3/4"x500	8.47	1061186																																																					
<p>342</p> 	<p><i>Noplūdes pievadi veļas mašīnām</i></p> <table border="1"> <tr><td>150</td><td>1.83</td><td>1061075</td></tr> <tr><td>200</td><td>2.17</td><td>1061076</td></tr> <tr><td>250</td><td>2.53</td><td>1061077</td></tr> <tr><td>300</td><td>2.92</td><td>1061078</td></tr> <tr><td>400</td><td>3.85</td><td>1061187</td></tr> <tr><td>500</td><td>4.50</td><td>1061188</td></tr> </table>	150	1.83	1061075	200	2.17	1061076	250	2.53	1061077	300	2.92	1061078	400	3.85	1061187	500	4.50	1061188																																				
150	1.83	1061075																																																					
200	2.17	1061076																																																					
250	2.53	1061077																																																					
300	2.92	1061078																																																					
400	3.85	1061187																																																					
500	4.50	1061188																																																					
<p>704/SM</p> 	<p><i>Lokanais pievads virtuves krānam ar izvelkamu dušu 10x3/8" (smalkā vītne)</i></p> <table border="1"> <tr><td>15</td><td>3.90</td><td>1061362</td></tr> </table>	15	3.90	1061362																																																			
15	3.90	1061362																																																					
<p>339</p> 	<p><i>Štucēris, divpusējs</i></p> <table border="1"> <tr><td>20x20</td><td>0.37</td><td>3936322</td></tr> <tr><td>24x24</td><td>0.37</td><td>3936321</td></tr> </table>	20x20	0.37	3936322	24x24	0.37	3936321																																																
20x20	0.37	3936322																																																					
24x24	0.37	3936321																																																					
<p>700/K</p> 	<p><i>Pagarinātāju komplekts jaucējkrānu pievadiem Ø10</i></p> <table border="1"> <tr><td>88mm</td><td>3.82</td><td>7125001</td></tr> </table>	88mm	3.82	7125001																																																			
88mm	3.82	7125001																																																					
<p>705</p> 	<p><i>Lokanie pievadi, hromēti D13x1/2</i></p> <table border="1"> <tr><td>30 FF</td><td>2.00</td><td>0161005</td></tr> <tr><td>30 FM</td><td>2.59</td><td>0161001</td></tr> <tr><td>40 FM</td><td>2.98</td><td>0161002</td></tr> <tr><td>50 FM</td><td>3.36</td><td>0161003</td></tr> <tr><td>60 FM</td><td>3.83</td><td>0161004</td></tr> </table>	30 FF	2.00	0161005	30 FM	2.59	0161001	40 FM	2.98	0161002	50 FM	3.36	0161003	60 FM	3.83	0161004																																							
30 FF	2.00	0161005																																																					
30 FM	2.59	0161001																																																					
40 FM	2.98	0161002																																																					
50 FM	3.36	0161003																																																					
60 FM	3.83	0161004																																																					
<p>700/A</p> 	<p><i>Pievads izlietnes krānam</i></p> <table border="1"> <tr><td>35 cm</td><td>4.75</td><td>2010001</td></tr> <tr><td>50 cm</td><td>7.15</td><td>2010002</td></tr> </table>	35 cm	4.75	2010001	50 cm	7.15	2010002																																																
35 cm	4.75	2010001																																																					
50 cm	7.15	2010002																																																					
<p>706/DZ</p> 	<p><i>Pievads gāzei EN14800</i></p> <table border="1"> <thead> <tr><th></th><th>FF</th><th></th><th>FM</th><th></th></tr> </thead> <tbody> <tr><td>500</td><td>11.13</td><td>1061520</td><td>500</td><td>11.13</td><td>1061526</td></tr> <tr><td>750</td><td>13.53</td><td>1061521</td><td>750</td><td>13.52</td><td>1061527</td></tr> <tr><td>1000</td><td>15.69</td><td>1061522</td><td>1000</td><td>15.69</td><td>1061528</td></tr> <tr><td>1250</td><td>17.20</td><td>1061523</td><td>1250</td><td>17.20</td><td>1061529</td></tr> <tr><td>1500</td><td>19.33</td><td>1061524</td><td>1500</td><td>19.44</td><td>1061530</td></tr> <tr><td>2000</td><td>26.34</td><td>1061525</td><td>2000</td><td>26.34</td><td>1061531</td></tr> </tbody> </table>		FF		FM		500	11.13	1061520	500	11.13	1061526	750	13.53	1061521	750	13.52	1061527	1000	15.69	1061522	1000	15.69	1061528	1250	17.20	1061523	1250	17.20	1061529	1500	19.33	1061524	1500	19.44	1061530	2000	26.34	1061525	2000	26.34	1061531													
	FF		FM																																																				
500	11.13	1061520	500	11.13	1061526																																																		
750	13.53	1061521	750	13.52	1061527																																																		
1000	15.69	1061522	1000	15.69	1061528																																																		
1250	17.20	1061523	1250	17.20	1061529																																																		
1500	19.33	1061524	1500	19.44	1061530																																																		
2000	26.34	1061525	2000	26.34	1061531																																																		
<p>706/DZ 90</p> 	<p><i>Pievads gāzei EN 14800</i></p> <table border="1"> <tr><td>500</td><td>15.34</td><td>1061532</td></tr> <tr><td>750</td><td>16.44</td><td>1061533</td></tr> <tr><td>1000</td><td>20.81</td><td>1061534</td></tr> <tr><td>1250</td><td>23.82</td><td>1061535</td></tr> <tr><td>1500</td><td>27.98</td><td>1061536</td></tr> <tr><td>2000</td><td>27.11</td><td>1061537</td></tr> </table>	500	15.34	1061532	750	16.44	1061533	1000	20.81	1061534	1250	23.82	1061535	1500	27.98	1061536	2000	27.11	1061537																																				
500	15.34	1061532																																																					
750	16.44	1061533																																																					
1000	20.81	1061534																																																					
1250	23.82	1061535																																																					
1500	27.98	1061536																																																					
2000	27.11	1061537																																																					







VEIKALS

VEIKALS







 <p>FX11102 Dušas klausule 1 režīmi (8*10 cm) HROMĒTA 9.70 4839035</p> <p><i>Fiksēts ūdens plūsmas režīms</i></p>	 <p>FX11113 Klausule krānam uz vannas malas (12.5*7 cm) BALTS/HROMS 9.72 4839002</p> <p>Iepakojums: maisiņš</p>
 <p>FX11104 Dušas klausule 1 režīmi (3.6*8.5 cm) HROMĒTA 8.50 4839036</p> <p><i>Fiksēts ūdens plūsmas režīms</i></p>	<p>FX12202 Dušas klausule Ø6.5 cm HROMĒTA 2.39 4839011</p> <p>FX2033 Ø6.5 cm (bez blistera) HROMĒTA 3.96 1139002</p> <p>Vecais kods: FX12033</p>
 <p>FX11105 Dušas klausule 1 režīmi Ø10.5 cm BALTS/HROMS 9.99 4839037</p> <p><i>Fiksēts ūdens plūsmas režīms</i></p>	<p>FX12204 Dušas klausule Ø8 cm HROMĒTA 4.35 4839017</p>
 <p>FX11106 Dušas klausule 1 režīmi Ø10 cm HROMĒTA 11.62 4839040</p> <p><i>Šīs dušas izbūve nodrošina ūdens sajaukšanu ar gaisu, kā rezultātā patērētais ūdens daudzums tiek ietaupīts līdz 30%.</i></p>	<p>FX51154 Dušas klausule 3 režīmi Ø9.5 cm HROMĒTA 7.26 4839025</p>
<p>FX31103 Dušas klausule 3 režīmi (12*12 cm) BALTS/HROMS 17.90 4839038</p> <p><i>Tai skaitā kaskādes režīms. Režīmi tiek pārslēgti ar ergonomisku pogu.</i></p>	<p>FX32132 Dušas klausule 2 režīmi Ø8 cm HROMĒTA 4.50 4839010</p>
 <p>FX31104 Dušas klausule 3 režīmi Ø10 cm HROMĒTA 12.39 4839039</p> <p><i>Šīs dušas izbūve nodrošina ūdens sajaukšanu ar gaisu, kā rezultātā patērētais ūdens daudzums tiek ietaupīts līdz 30%.</i></p>	<p>FX32233 Dušas klausule 3 režīmi Ø9.5 cm HROMĒTA 5.69 4839021</p>
 <p>FX31102 Dušas klausule 3 režīmi Ø12 cm HROMĒTA 12.08 4839034</p>	





VEIKALS

VEIKALS

 FX51153 <i>Dušas klausule 5 režīmi</i> <i>Ø7.5 cm</i> <i>HROMĒTA</i> 6.31 4839001 Vecais kods: 51573	 FX11201 <i>Dušas galva</i> <i>Diametrs 100 mm</i> <i>HROMĒTA</i> 6.90 4839046
 FX11205 <i>Klausule virtuves izlietnes krānam</i> <i>Ø4.8 cm</i> <i>HROMĒTA</i> 6.89 4839007 Vecais kods: FX1127	 FX12202+108 <i>Dušas kalusule ar pievadu</i> <i>Iepakojums blisteris</i> 6.23 4830009 Rokas duša D6.5 cm Dušas pievads 150 cm
 FX11101 <i>Klausule bidē krānam</i> <i>Ø3 cm</i> <i>HROMĒTA</i> 4.45 4839015 Vecais kods: FX18107	 FX2033+10815 <i>Dušas kalusule ar pievadu un turētāju</i> <i>Iepakojums, kartona blisteris</i> 3.60 4830011 Rokas duša D6.5 cm Dušas pievads 150 cm Stiprinājums FL15 (plastmasa)
 FX11108 <i>Dušas klausule</i> <i>Ø10 cm</i> <i>BALTS/HROMS</i> 7.99 4839028	 FX94000 <i>Kronšteins dušas galvai</i> <i>Misiņa</i> 15 cm 17.02 4839042
 FX11309 <i>Dušas klausule</i> <i>(6.5*4.0 cm)</i> <i>HROMĒTA</i> 6.25 4839029	 FX2580 <i>Dušas kronšteins</i> <i>Plastmasa</i> <i>HROMĒTA</i> 4.05 4839003
 FX11114 <i>Dušas galva</i> <i>Diametrs 200 mm</i> <i>HROMĒTA</i> 20.88 4839024	 FL15 <i>Dušas kronšteins</i> <i>bez iepakojuma</i> <i>Plastmasa</i> <i>HROMĒTA</i> 1.56 7139000
 FX1546 <i>Dušas galva</i> <i>Diametrs 80 mm</i> <i>HROMĒTA</i> 6.02 4839018 Vecais kods: FX1695	 FX2582 <i>Dušas kronšteins (plastmasa)</i> 2.95 4839005  FX2583 <i>Dušas kronšteins (metāla)</i> 17.02 4839023
 FX11200 <i>Dušas galva</i> <i>Diametrs 100 mm</i> <i>HROMĒTA</i> 6.32 4839045	 FX2584 <i>Dušas kronšteins</i> <i>Plastmasa</i> <i>HROMĒTA</i> 2.39 4839022

VEIKALS



	<i>Dušas pievads, sudrabots PVC</i> 105-MG 170 cm 11.25 4810009 <i>HROMĒTS</i>
	<i>Dubultā pinuma dušas pievads</i> 106-MG 80 cm 5.60 4810017 150 cm 6.55 4810001 200 cm 7.79 4810002 <i>HROMĒTS</i>
	<i>Dušas pievads</i> 108-MG 150 cm 3.60 4810011 200 cm 4.47 4810012 <i>HROMĒTS</i>
	<i>Dušas pievads, elastīgais</i> 109-MG 150 cm 9.10 4810010 <i>170-220 cm</i> <i>HROMĒTS</i>
	<i>Dušas pievads Anti-Twist</i> 111-MG 150 cm 7.32 4810006 <i>HROMĒTS</i>
	<i>Dušas pievads jaucējkrānam MG2059</i> RMG2059 50 cm 9.18 7110042 <i>Neilona pinums</i>
	<i>Dušas stienis komplektā</i> FX31104+255 36.45 4830015 <i>3 režīmi</i> <i>HROMĒTS</i> Rokas duša Ø10 cm Dušas pievads 150 cm Stienis pa centriem 52 cm

	<i>Dušas stienis komplektā</i> FX31105+259 49.44 4830020 <i>melns</i> Rokas duša Ø11.5 cm Dušas pievads 150 cm Stienis pa centriem 55 cm
	<i>Dušas stienis komplektā</i> FX32233+252 24.04 4830003 <i>HROMĒTS</i> Rokas duša Ø9.5 cm Dušas pievads 150 cm Stienis pa centriem 52 cm Vecais kods: 2017+252
	<i>Dušas stienis komplektā</i> FX12202+253 18.81 4830004 <i>HROMĒTS</i> Rokas duša Ø6.5 cm Dušas pievads 150 cm Stienis pa centriem 54 cm Vana kods: 2033+253
	<i>Dušas stienis 18 mm</i> FX253 11.02 4830006 <i>HROMĒTS</i> Stienis pa centriem 54 cm
	<i>Dušas stienis 22 mm</i> FX254 17.99 4830013 <i>HROMĒTS</i> Stienis pa centriem 60 cm

VEIKALS

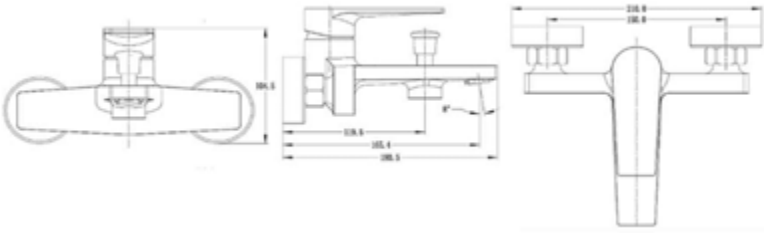

FS1126-2 *Vannas krāns bez komplekta*

89.96 **1102004**



FS1127-2 *Vannas krāns bez komplekta*

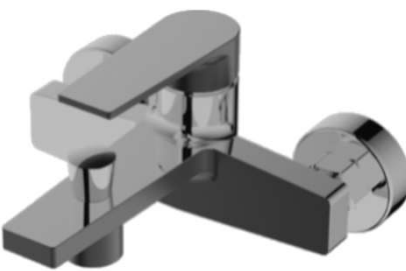
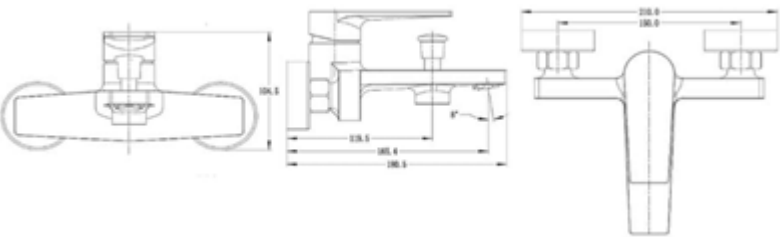



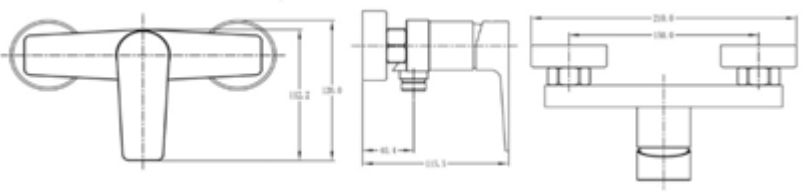

89.96 **1102075**



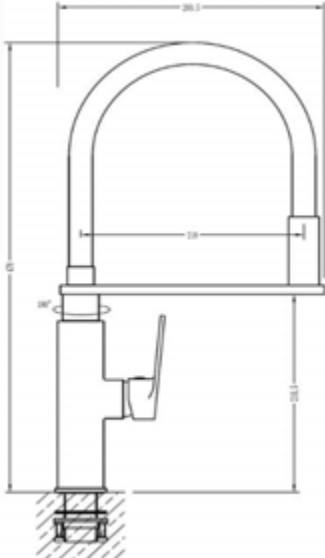

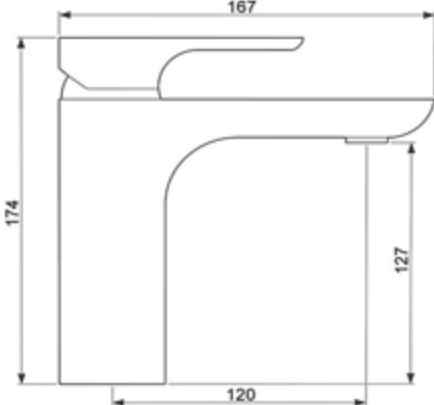

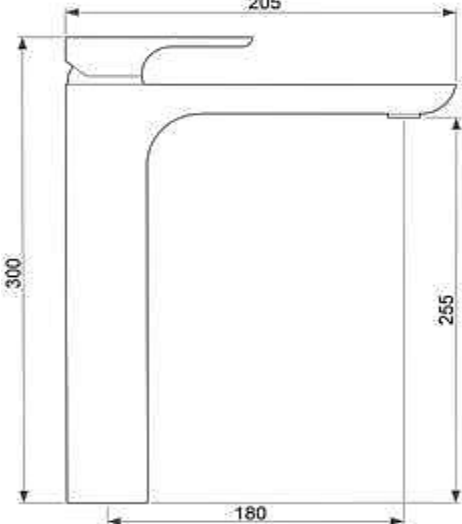



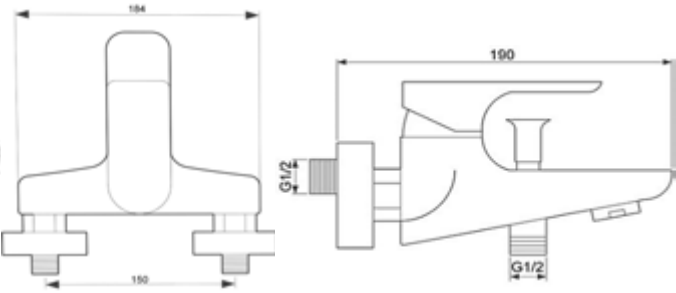

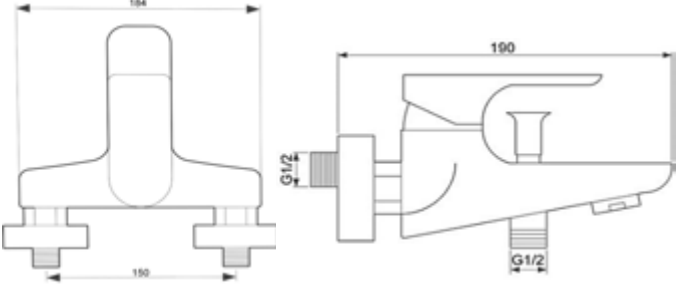
FS1127-4 *Dušas krāns bez komplekta*

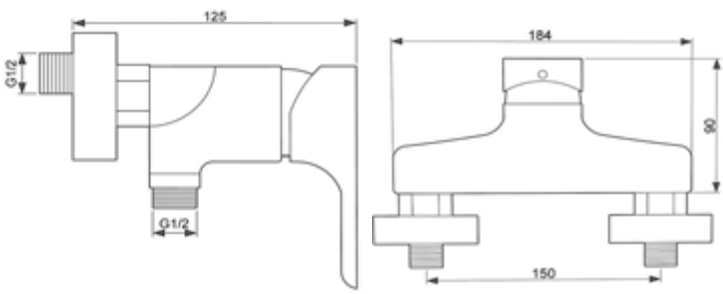
63.11 **1102076**

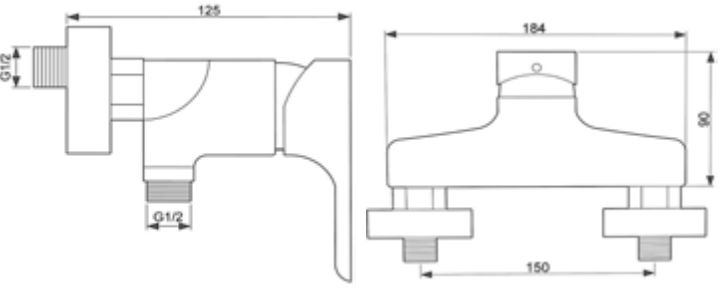
	<p>MG-2359</p> 	<p><i>Virtuves izlietnes krāns ar lokanu izteku</i></p> <p>137.71</p> <p>7102188</p> <p>35 mm</p> 
	<p>MG - 2360</p> 	<p><i>Keramiskās izlietnes krāns</i></p> <p>77.10</p> <p>7102102</p> <p>35 mm</p> 
	<p>MG - 2362</p> 	<p><i>Keramiskās izlietnes krāns, augstais</i></p> <p>121.12</p> <p>7102103</p> <p>35 mm</p> 

<p style="text-align: center;">MG - 2320</p> 	<p style="text-align: right;"><i>Vannas krāns, bez komplekta</i></p> <p style="text-align: center;">106.22</p> <p style="text-align: right;">7102104</p> 	<p style="text-align: right;">35 mm</p> 
	<p style="text-align: center;">MG - 2321</p> <p style="text-align: right;"><i>Vannas krāns ar komplektu</i></p> <p style="text-align: center;">122.20</p> <p style="text-align: right;">7102105</p> 	<p style="text-align: right;">35 mm</p> 
	<p style="text-align: center;">MG - 2340</p> <p style="text-align: right;"><i>Dušas krāns bez komplekta</i></p> <p style="text-align: center;">76.64</p> <p style="text-align: right;">7102106</p> 	<p style="text-align: right;">35 mm</p> 
	<p style="text-align: center;">MG - 2341</p> <p style="text-align: right;"><i>Dušas krāns ar komplektu</i></p> <p style="text-align: center;">83.31</p> <p style="text-align: right;">7102107</p> 	<p style="text-align: right;">35 mm</p> 

VEIKALS

MG - 2220

EUR

Vannas krāns ar termostatu



103.02

7105001

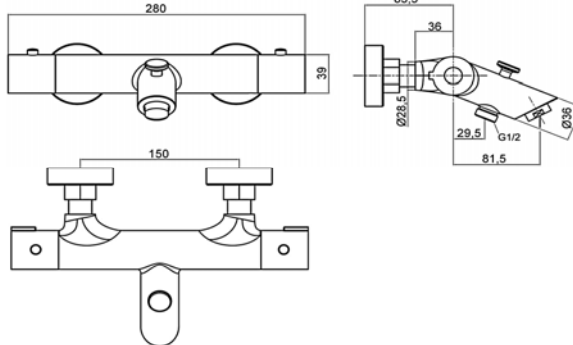

MG - 2240

Dušas krāns ar termostatu



92.31

7105002

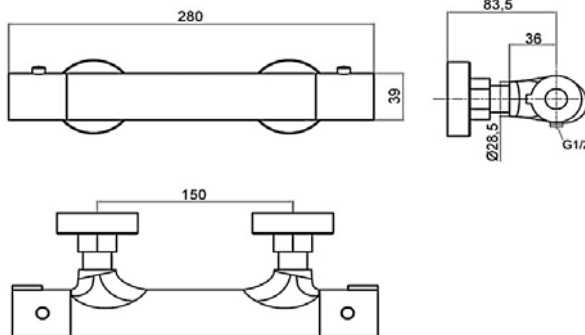

MG-2290

Dušas krāns ar dušas stieni

201.91

7105003

MG-2292

Dušas krāns ar dušas stieni (neuzkarstošs korpuss)

256.40

7105006

MG-2295









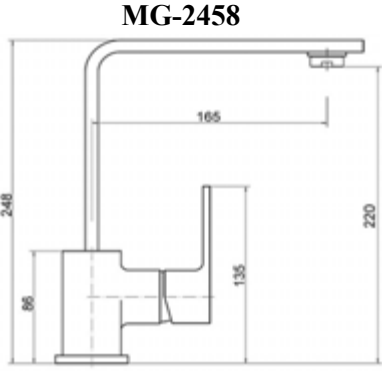

Dušas krāns (ar izteku), ar dušas stieni

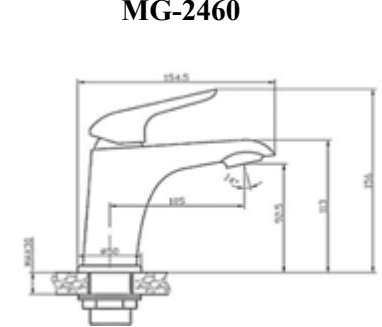
244.77

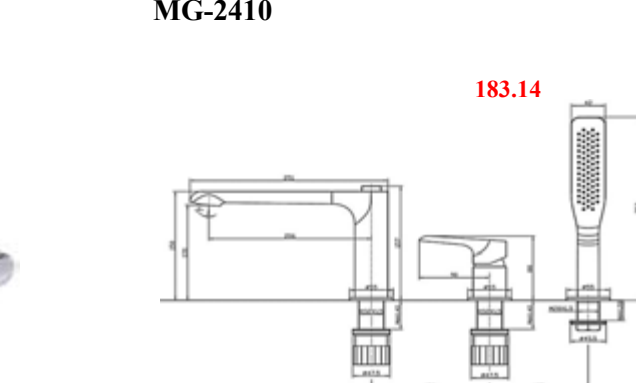

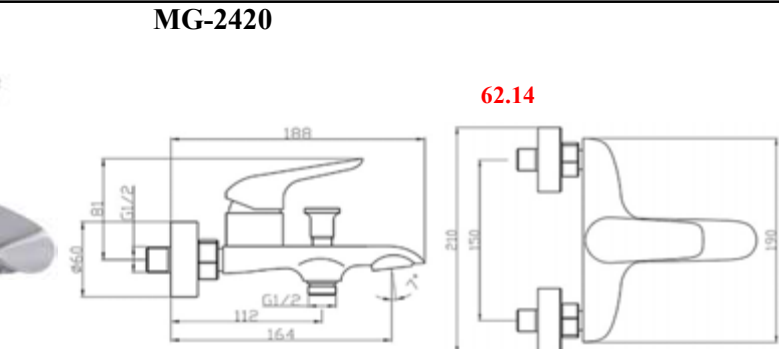

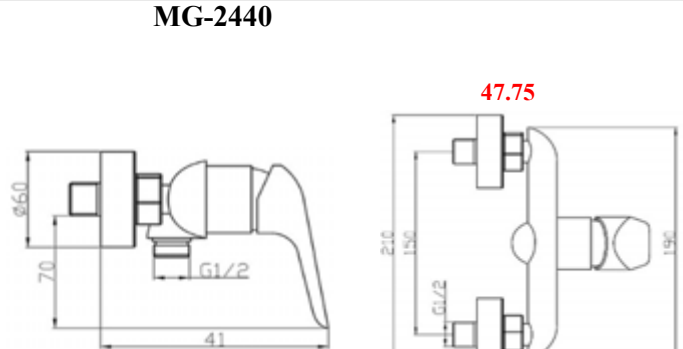



7105004

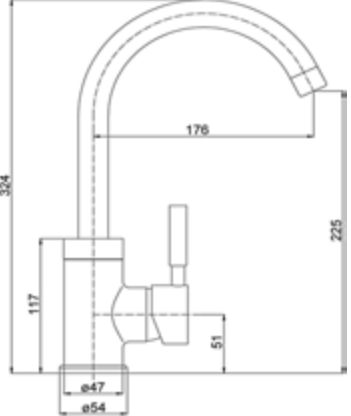

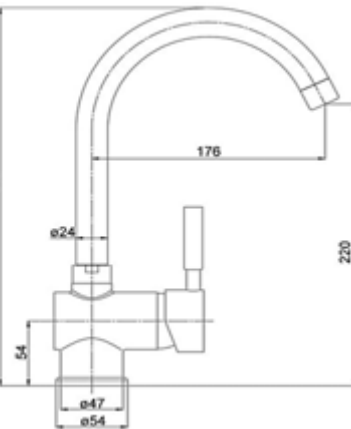
VEIKALS

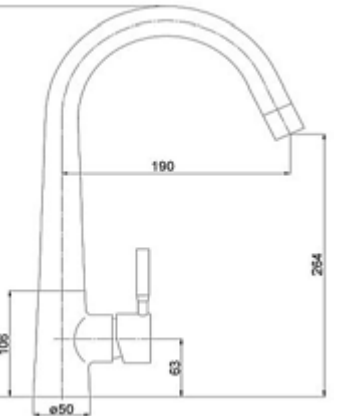

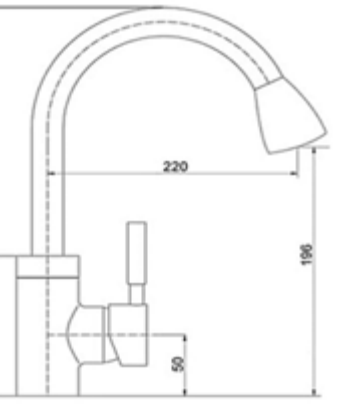



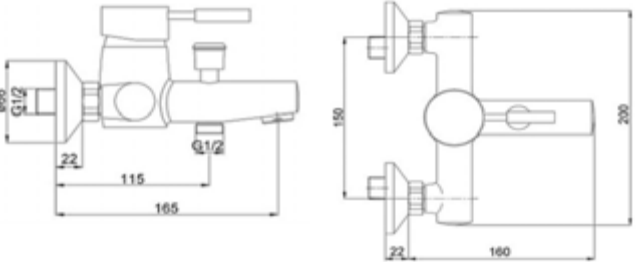

	<p>MG-2458</p> 	<p>EUR 70.74</p>	<p><i>Keramiskās izlietnes krāns</i> 7102157</p>	<p>35 mm</p> 
	<p>MG-2460</p> 	<p>58.32 58.32</p>	<p><i>Keramiskās izlietnes krāns</i> COLD START 7102061 7102201</p>	<p>35 mm</p> 
	<p>MG-2410</p> 	<p>183.14</p>	<p><i>Krāns uz vannas malas</i> 7102062</p>	<p>35 mm</p> 
	<p>MG-2420</p> 	<p>62.14</p>	<p><i>Vannas krāns</i> 7102172</p>	<p>35 mm</p> 
	<p>MG-2440</p> 	<p>47.75</p>	<p><i>Dušas kabīnes krāns</i> 7102171</p>	<p>35 mm</p> 

VEIKALS

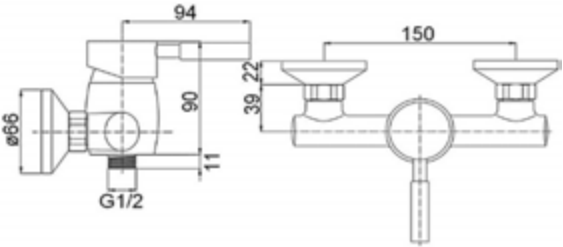
	<p>MG - 2055</p> 	<p>EUR</p> <p>52.78</p>	<p><i>Virtuves izlietnes krāns</i></p> <p>7103190</p> <p>40 mm</p> 
	<p>MG - 2054</p> 	<p>53.50</p>	<p><i>Virtuves izlietnes krāns</i></p> <p>7103189</p> <p>40 mm</p> 
	<p>MG - 2053</p> 	<p>70.86</p>	<p><i>Virtuves izlietnes krāns</i></p> <p>7102161</p> <p>35 mm</p> 
	<p>MG-2056</p> 	<p>89.61</p>	<p><i>Virtuves izlietnes krāns ar izvelkamu dušu</i></p> <p>7103203</p> <p>35 mm</p> 

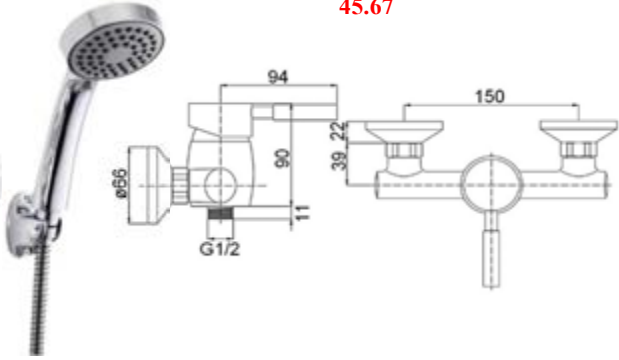
VEIKALS

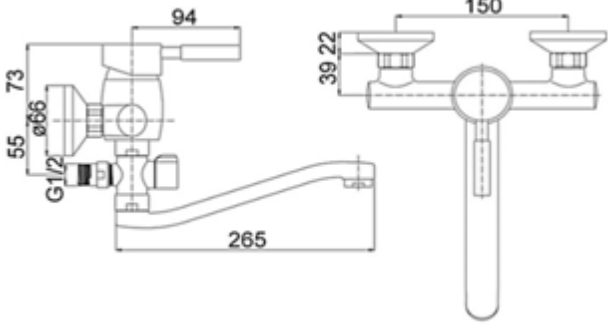
	<p>MG-2057</p>	<p><i>Virtuves izlietnes krāns ar izvelkamu izteku</i></p>	<p>76.53</p>	<p>7103204</p>
	<p>35 mm</p>			
	<p>MG - 2058</p>	<p><i>Virtuves izlietnes krāns ar izvadu filtrētam ūdenim</i></p>	<p>77.00</p>	<p>7102193</p>
	<p>35 mm</p>			
	<p>MG - 2060</p>	<p><i>Keramiskās izlietnes krāns</i></p>	<p>65.51</p>	<p>7103191</p>
	<p>40 mm</p>			

	<p>MG-2020</p>	<p>Vannas krāns</p>	<p>51.72</p>	<p>7103201 40 mm</p>		
	<p>MG - 2040</p>	<p>Dušas kabīnes krāns</p>	<p>39.04</p>	<p>7103192 40 mm</p>		
	<p>MG - 2041</p>	<p>Dušas kabīnes krāns komplektā</p>	<p>45.67</p>	<p>7103093 40 mm</p>		
	<p>MG - 2036</p>	<p>Vannas krāns</p>	<p>62.18</p>	<p>7103193 40 mm</p>		

VEIKALS

EUR

Virtuves izlietnes krāns

53.63

7102073

JAUNUMS

35 mm



MG - 1954

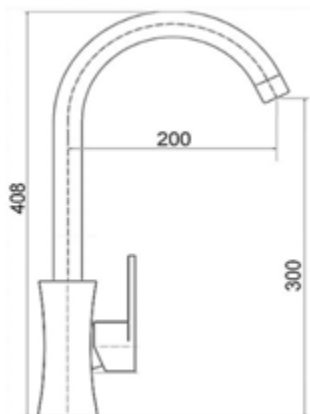

MG-1955

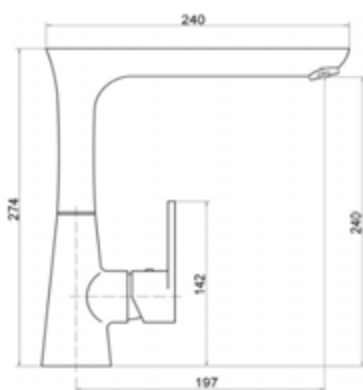

70.74

7102156

35 mm



Virtuves izlietnes krāns



MG - 1960

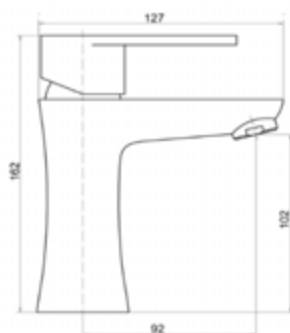

45.69

7102158

35 mm



Keramiskās izlietnes krāns



MG - 1962

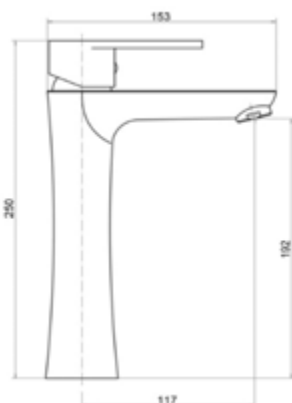







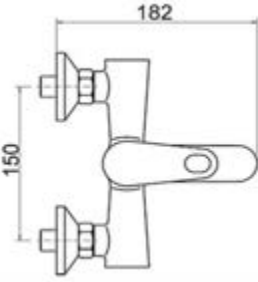
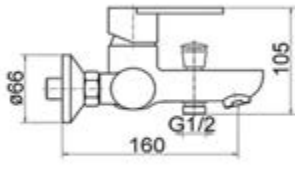

59.30

7102159

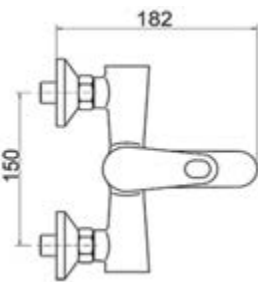
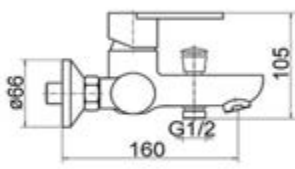
35 mm

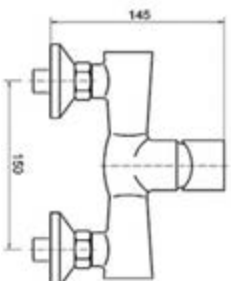
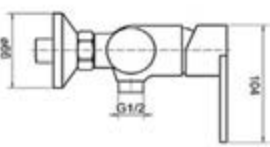

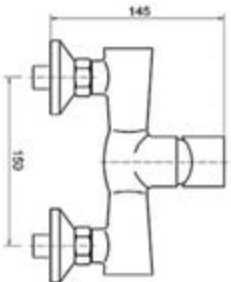
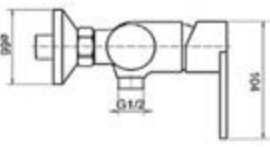
Keramiskās izlietnes krāns

	<p>MG - 1920</p> 	<p>57.66</p> 	<p><i>Vannas krāns</i></p> <p>7102153 35 mm</p> 
	<p>MG - 1921</p> 	<p>66.86</p> 	<p><i>Vannas krāns</i></p> <p>7102164 35 mm</p> 
	<p>MG - 1940</p> 	<p>43.06</p> 	<p><i>Duļas kabīnes krāns</i></p> <p>7102155 35 mm</p> 
	<p>MG - 1941</p> 	<p>51.76</p> 	<p><i>Duļas kabīnes krāns</i></p> <p>7102165 35 mm</p> 

MG - 1934 *Vannas krāns, izteka 300 mm*

7102154
35 mm

MG - 1990 *Dušas krāns ar dušas stieni*

156.98 **7102184**
35 mm









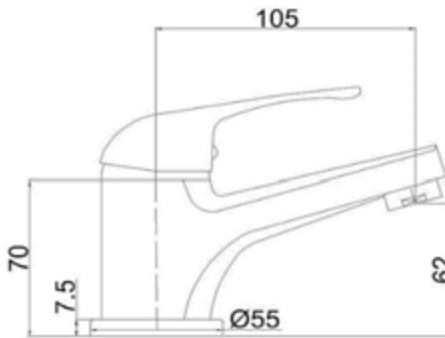

MG - 6001-5 *Virtuves jaucējkrāns ar caurplūdes sildītāju*

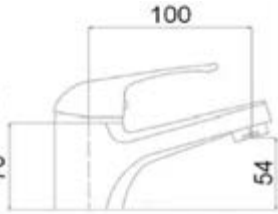
3 KW

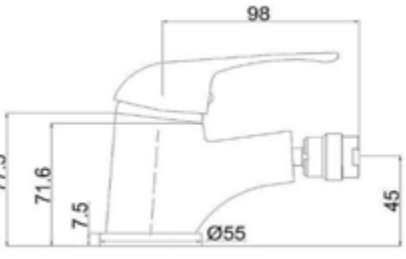
MG6001-5 **69.99** **7108001**

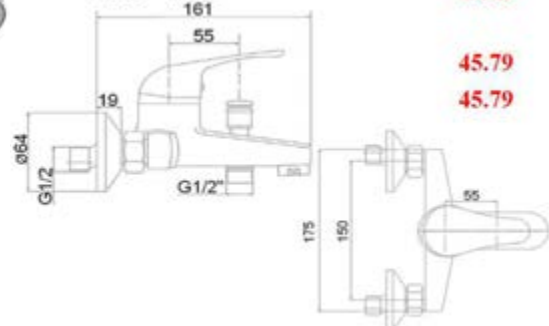

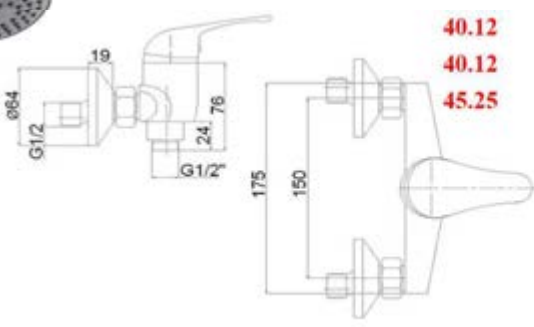



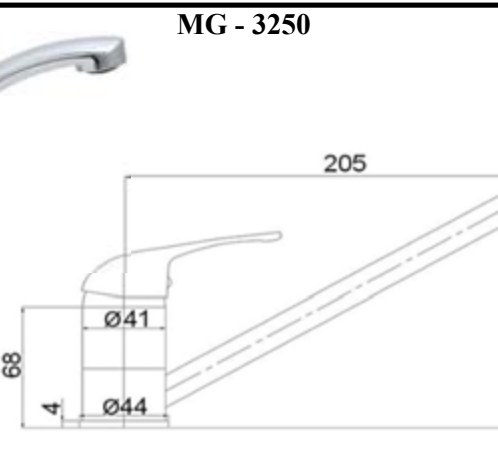

VEIKALS

	<p>MG - 6250</p> 	<p>EUR</p> <p>31.07 31.07 36.21</p>	<p><i>Virtuves izlietnes krāns</i></p> <table border="0"> <tr> <td>JUPITS</td> <td>7103003</td> </tr> <tr> <td>URANS</td> <td>7103010</td> </tr> <tr> <td>LG</td> <td>7104005</td> </tr> </table> <p>JUPITS URANS 40 mm</p> 	JUPITS	7103003	URANS	7103010	LG	7104005
JUPITS	7103003								
URANS	7103010								
LG	7104005								
	<p>MG - 6255</p> 	<p>42.48 42.48 47.60</p>	<p><i>Virtuves izlietnes krāns</i></p> <table border="0"> <tr> <td>JUPITS</td> <td>7103009</td> </tr> <tr> <td>URANS</td> <td>7103012</td> </tr> <tr> <td>LG</td> <td>7103200</td> </tr> </table> <p>JUPITS URANS 40 mm</p> 	JUPITS	7103009	URANS	7103012	LG	7103200
JUPITS	7103009								
URANS	7103012								
LG	7103200								
	<p>MG - 6252</p> 	<p>41.43 41.43 46.56</p>	<p><i>Virtuves izlietnes krāns</i></p> <table border="0"> <tr> <td>JUPITS</td> <td>7103185</td> </tr> <tr> <td>URANS</td> <td>7103187</td> </tr> <tr> <td>LG</td> <td>7104012</td> </tr> </table> <p>JUPITS URANS 40 mm</p> 	JUPITS	7103185	URANS	7103187	LG	7104012
JUPITS	7103185								
URANS	7103187								
LG	7104012								
	<p>MG - 6253</p> 	<p>43.69 43.69</p>	<p><i>Virtuves izlietnes krāns</i></p> <table border="0"> <tr> <td>JUPITS</td> <td>7103205</td> </tr> <tr> <td>URANS</td> <td>7103206</td> </tr> </table> <p>JUPITS URANS 40 mm</p> 	JUPITS	7103205	URANS	7103206		
JUPITS	7103205								
URANS	7103206								

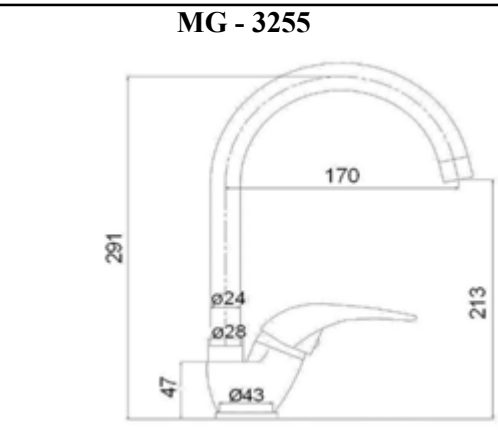
	<p>MG - 6260</p> 	<p>34.13 34.13 39.26</p>	<p><i>Keramiskās izlietnes krāns</i></p> <p>JUPITS 7103015 URANS 7103016 LG 7104004</p> <p>JUPITS URANS 40 mm</p> 
	<p>MG - 6270</p> 	<p>49.06 49.06</p> <p>JAUNUMS</p>	<p><i>Izlietnes krāns ar bidetu</i></p> <p>JUPITS 7103077 URANS 7103078</p> <p>JUPITS URANS 40 mm</p> 
	<p>MG - 6280</p> 	<p>32.40 32.40</p>	<p><i>Bidē krāns ar noteci</i></p> <p>JUPITS 7103019 URANS 7103020</p> <p>JUPITS URANS 40 mm</p> 
	<p>MG - 6221</p> 	<p>EUR</p> <p>45.79 45.79</p>	<p><i>Vannas krāns ar dušu</i></p> <p>JUPITS 7103051 URANS 7103052</p> <p>JUPITS URANS 40 mm</p> 
	<p>MG - 6241</p> 	<p>40.12 40.12 45.25</p>	<p><i>Krāns dušas kabīnei</i></p> <p>JUPITS 7103035 URANS 7103036 LG 7104009</p> <p>JUPITS URANS 40 mm</p> 

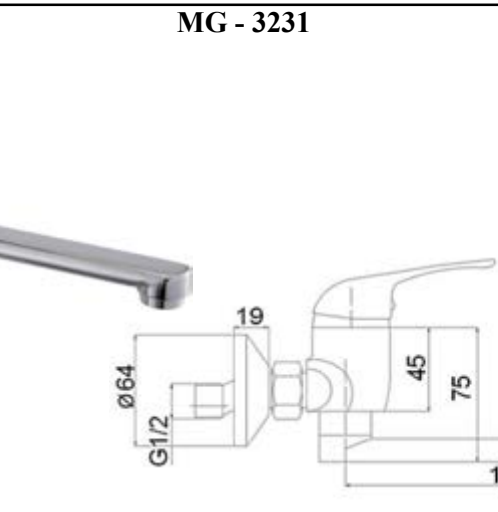

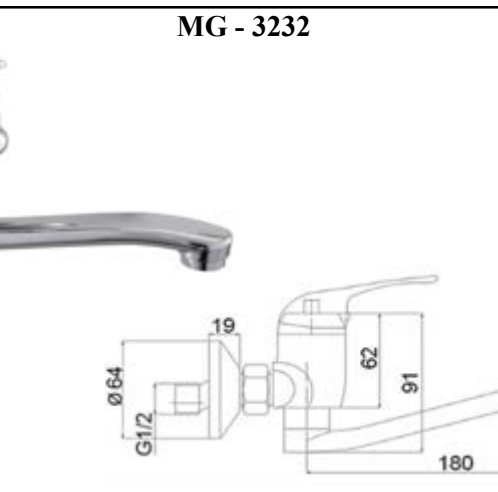







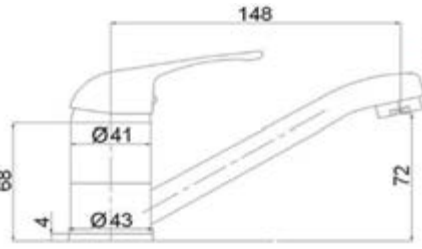



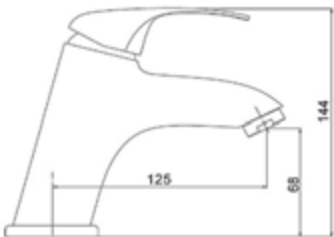



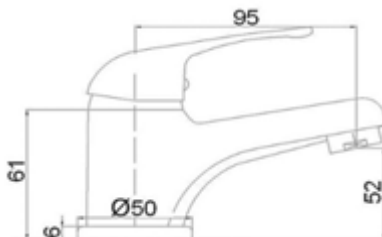

	<p>MG - 6233</p> <p>Pārslēdzējs</p>	<p><i>Vannas krāns, izteka 200 mm</i></p> <p>53.52 JUPITS 7103071 53.52 URANS 7103072</p> <p>JUPITS URANS 40 mm</p>
	<p>MG - 6234</p> <p>Pārslēdzējs</p>	<p><i>Vannas krāns, izteka 300 mm</i></p> <p>55.13 JUPITS 7103031 55.13 URANS 7103032</p> <p>JUPITS URANS 40 mm</p>
	<p>MG - 6235</p> <p>Pārslēdzējs</p>	<p><i>Vannas krāns, izteka 200 mm</i></p> <p>53.52 JUPITS 7103067 53.52 URANS 7103068</p> <p>JUPITS URANS 40 mm</p>
	<p>MG - 6236</p> <p>Pārslēdzējs</p>	<p><i>Vannas krāns, izteka 300 mm</i></p> <p>55.13 JUPITS 7103027 55.13 URANS 7103028</p> <p>JUPITS URANS 40 mm</p>

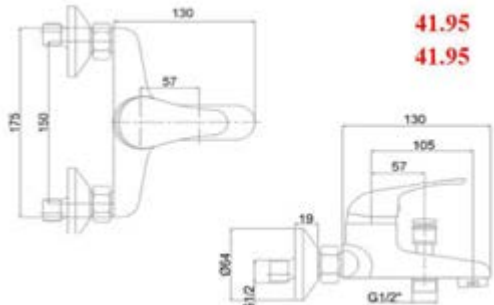
VEIKALS



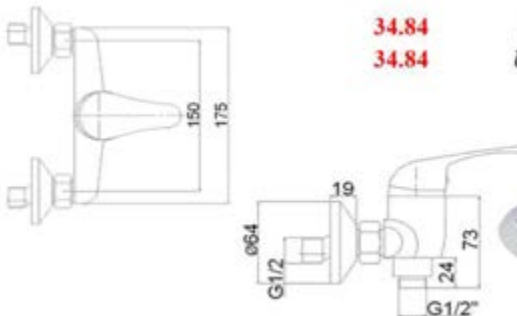







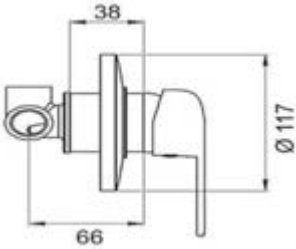

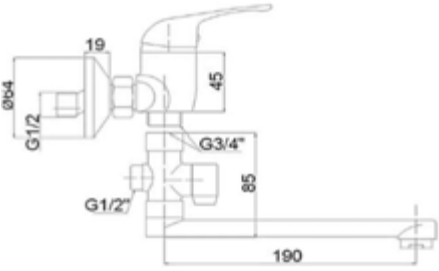
	<p>MG - 3250</p> 	<p>EUR</p> <p>26.39 26.39</p>	<p><i>Virtuves izlietnes krāns</i></p> <p>SATO 7102002 URANS 7102003</p> <p>SATO URANS 35 mm</p> 
	<p>MG - 3255</p> 	<p>37.54 37.54</p>	<p><i>Virtuves izlietnes krāns</i></p> <p>SATO 7102008 URANS 7102009</p> <p>SATO URANS 35 mm</p> 
	<p>MG - 3231</p> 	<p>35.52 35.52</p>	<p><i>Virtuves izlietnes krāns</i></p> <p>SATO 7102029 URANS 7102030</p> <p>SATO URANS 35 mm</p> 
	<p>MG - 3232</p> 	<p>35.52 35.52</p>	<p><i>Virtuves izlietnes krāns</i></p> <p>SATO 7102032 URANS 7102033</p> <p>SATO URANS 35 mm</p> 

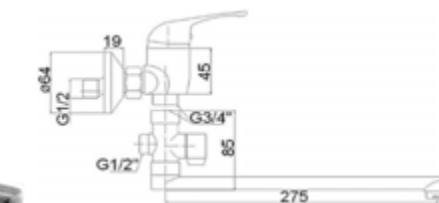
Sērija ECO





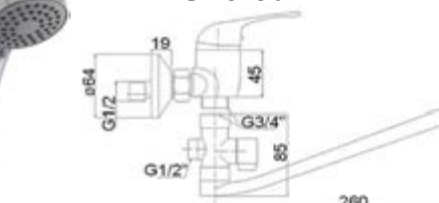

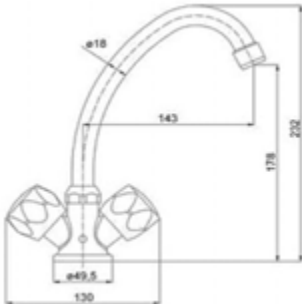

VEIKALS

MG - 3251				<i>Izlietnes krāns, izteka 150 mm</i>	
		25.97 25.97	<i>SATO</i> <i>URANS</i>	7102005 7102006	<i>SATO</i> <i>URANS</i> 35 mm   
MG-3263				<i>Keramiskās izlietnes krāns</i>	
		32.55 31.84	<i>SATO</i> <i>URANS</i>	7102166 7102167	<i>SATO</i> <i>URANS</i> 35 mm   
MG - 3260				<i>Keramiskās izlietnes krāns</i>	
		26.88 26.88	<i>SATO</i> <i>URANS</i>	7102011 7102012	<i>SATO</i> <i>URANS</i> 35 mm   
MG - 3221				<i>Vannas krāns ar dušu</i>	
		41.95 41.95	<i>SATO</i> <i>URANS</i>	7102038 7102039	<i>SATO</i> <i>URANS</i> 35 mm   
MG - 3241				<i>Krāns dušas kabīnei</i>	
		34.84 34.84	<i>SATO</i> <i>URANS</i>	7102026 7102027	<i>SATO</i> <i>URANS</i> 35 mm   

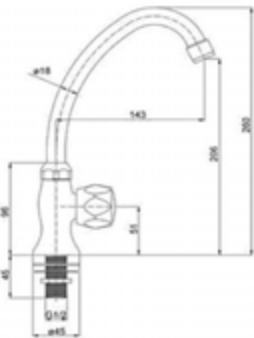

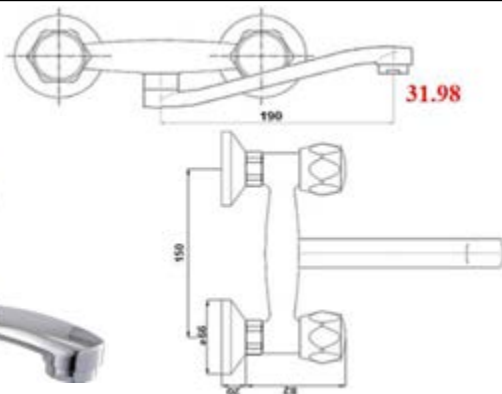

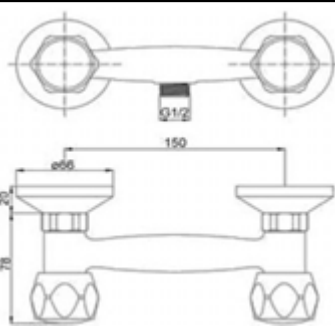

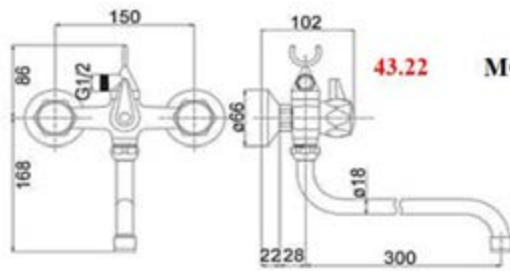



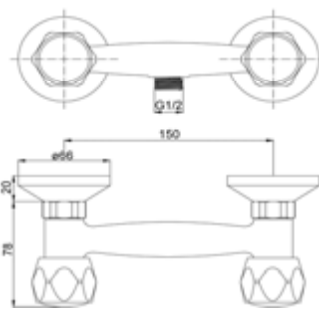

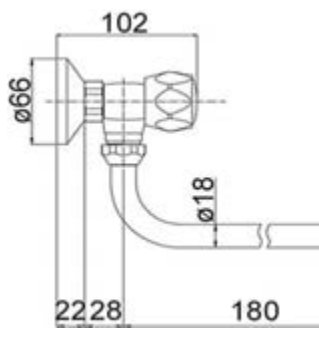

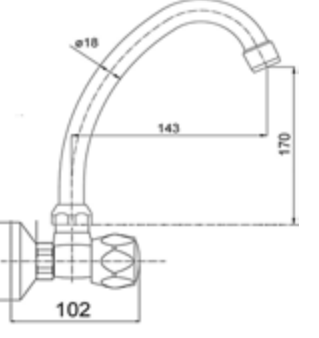

VEIKALS

	<p>MG - 3248</p> 	<p>EUR 59.77 59.65</p>	<p>Zemapmetuma dušas krāns</p> <p>SATO 7102185 URANS 7102186</p> <p>SATO URANS 35 mm</p> 
	<p>MG - 3233</p> 	<p>43.50 43.50</p>	<p>Vannas krāns, izteka 200 mm</p> <p>SATO 7102053 URANS 7102054</p> <p>Pārslēdzējs SATO URANS 35 mm</p> 
	<p>MG - 3234</p> 	<p>45.99 45.99</p>	<p>Vannas krāns, izteka 300 mm</p> <p>SATO 7102023 URANS 7102024</p> <p>Pārslēdzējs SATO URANS 35 mm</p> 
	<p>MG - 3235</p> 	<p>43.50 43.50</p>	<p>Vannas krāns, izteka 200 mm</p> <p>SATO 7102050 URANS 7102051</p> <p>Pārslēdzējs SATO URANS 35 mm</p> 
	<p>MG - 3236</p> 	<p>45.99 45.99</p>	<p>Vannas krāns, izteka 300 mm</p> <p>SATO 7102020 URANS 7102021</p> <p>Pārslēdzējs SATO URANS 35 mm</p> 







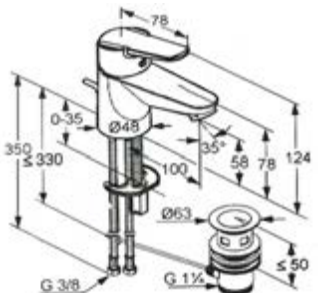

VEIKALS

		EUR	<i>Virtuves izlietnes krāns</i>			
		29.20	MG-2150	RING	7101001	
		30.58	MG-2150/R	RETRO	7101002	
			<i>Izlietnes krāns vienam ūdenim</i>			
		18.90	MG-2151	RING	7101003	
		19.60	MG-2151	RETRO	7101010	
		31.98	MG-2132	RING	7101008	
		25.72	MG-2140	RING	7101004	
				27.12	MG-2140/R	RETRO
		41.81	MG-2134	RING	7101006	
				43.22	MG-2134/R	RETRO

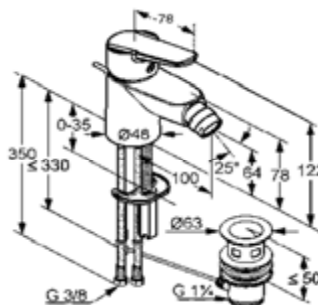
VEIKALS

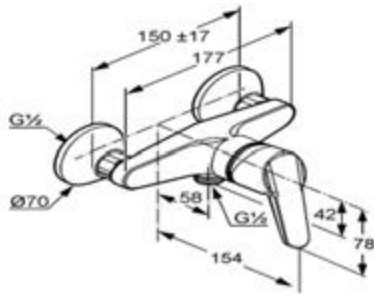
				<p>Jaucējkrāns no sienas (izeja 3/4")</p> <p>EUR 27.55</p>	<p>MG-2130 RING 7101011</p>	
				<p>30.22</p>	<p>MG-2130/R RETRO 7101012</p>	
				<p>30.75</p>	<p>MG-2145 RING 7101013</p>	
				<p>33.42</p>	<p>MG-2145/R RETRO 7101014</p>	
				<p>30.75</p>	<p>MG-2146 RING 7101015</p>	
				<p>33.42</p>	<p>MG-2146/R RETRO 7101016</p>	
				<p>30.75</p>	<p>MG-2147 RING 7101017</p>	
				<p>33.42</p>	<p>MG-2147/R RETRO 7101018</p>	

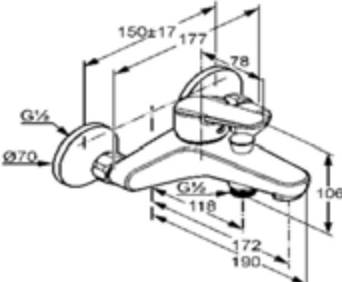
JAUCĒJKRĀNI AR SVIRAS ROKTURI

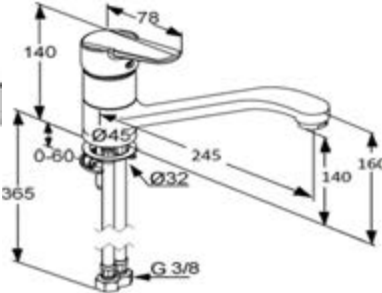
	<p>D-VISE</p> 	<p>371810590</p>	<p><i>Keramiskās izlietnes krāns</i></p> <p>100.73 0802017</p>
	<p>D-VISE</p> 	<p>375320590</p>	<p><i>Bidē krāns</i></p> <p>103.06 0802018</p>
	<p>D-VISE</p> 	<p>378420590</p>	<p><i>Dušas krāns</i></p> <p>101.61 0802045</p>
	<p>D-VISE</p> 	<p>376820590</p>	<p><i>Vannas krāns</i></p> <p>130.17 0802030</p>
	<p>D-VISE</p> 	<p>379550590</p>	<p><i>Virtuves izlietnes krāns</i></p> <p>104.37 0802003</p>



JAUCĒJKRĀNI AR SVIRAS ROKTURI











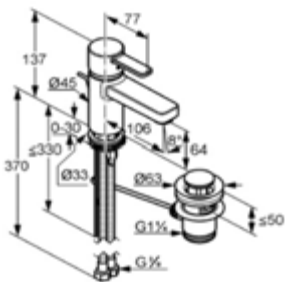

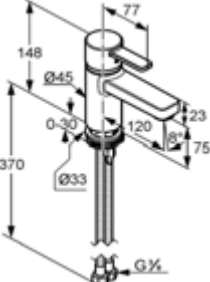
VEIKALS
EUR

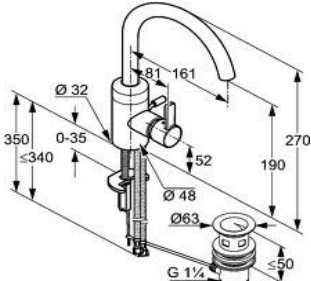
		<p>LOGO NEO</p>	<p>Keramiskās izlietnes krāns</p>
<p>372800575</p>	<p>80.74</p>	<p>0802034</p>	
		<p>LOGO NEO</p>	<p>Bidē krāns</p>
<p>375310575</p>	<p>124.12</p>	<p>0802101</p>	
		<p>LOGO NEO</p>	<p>Vannas krāns</p>
<p>376810575</p>	<p>125.38</p>	<p>0802001</p>	
		<p>LOGO NEO</p>	<p>Dušas krāns</p>
<p>378410575</p>	<p>111.31</p>	<p>0802006</p>	
		<p>LOGO NEO</p>	<p>Virtuves izlietnes krāns</p>
<p>379130575</p>	<p>120.34</p>	<p>0802008</p>	

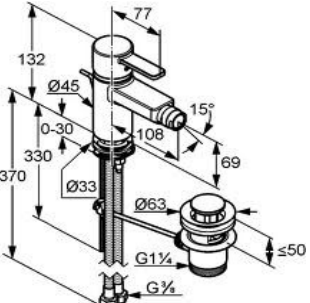
JAUCĒJKRĀNI AR SVIRAS ROKTURI

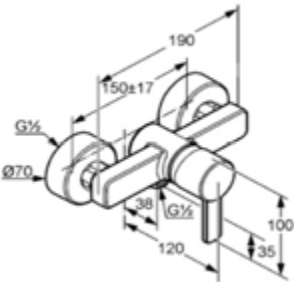
VEIKALS
EUR

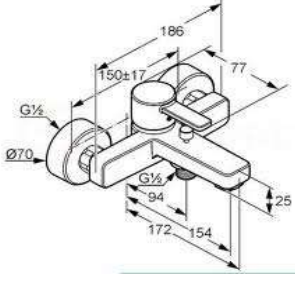
		ZENTA	Keramiskās izlietnes krāns	382500575 hroms 184.75 0802086 382509175 balts/hroms 212.80 0802016
		ZENTA XL	Keramiskās izlietnes krāns (bez noteces)	382620575 191.23 0802033
		ZENTA	Keramiskās izlietnes krāns (augstais)	382550575 314.67 0802087
		ZENTA	Bidē krāns	385300575 hroms 239.78 0802088 385309175 balts/hroms
		ZENTA	Dušas krāns	388700575 hroms 211.34 0802090 388709175 balts/hroms
		ZENTA	Vannas krāns	386700575 hroms 262.01 0802089 386709175 balts/hroms









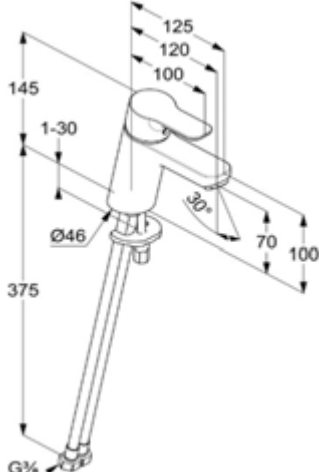

JAUCĒJKRĀNI AR SVIRAS ROKTURI

VEIKALS
EUR

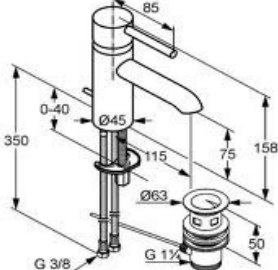
	<p>ZENTA <i>Vannas krāns ar termostatu</i></p> <p>351010538 hroms 265.74 0805015 351018638 melns/hroms 351019138 balts/hroms</p>
	<p>ZENTA <i>Dušas krāns ar termostatu</i></p> <p>351000538 hroms 195.29 0805014 351009138 balts/hroms</p>
	<p>OBJEKTA <i>Dušas krāns ar termostatu</i></p> <p>352000538 341.24 0805004</p>
	<p>OBJEKTA <i>Vannas krāns ar termostatu</i></p> <p>352600538 314.29 0805005</p>
	<p>385320575 TERCIO <i>Bidē krāns</i></p> <p>127.95 0802055</p> <p>Izpārdošana 50.00</p>

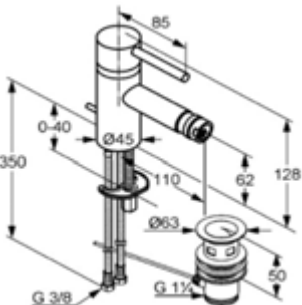

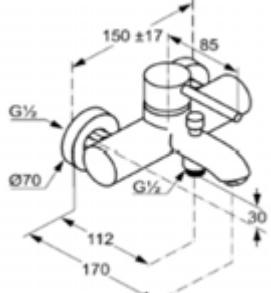

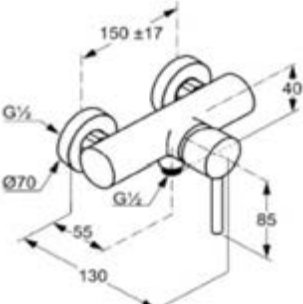

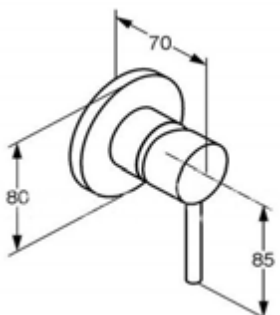

JAUCĒJKRĀNI AR SVIRAS ROKTURI

VEIKALS
EUR

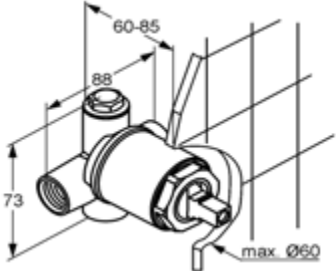
		<p style="text-align: right;"><i>Keramiskās izlietnes krāns</i></p> <p>37280565 93.92 0802125</p> <p>PURE&EASY</p>
		<p>BOZZ <i>Keramiskās izlietnes krāns</i></p> <p>382910576 164.42 0802092</p>
		<p>BOZZ <i>Bidē krāns</i></p> <p>385330576 267.73 0802093</p>
		<p>BOZZ <i>Vannas krāns</i></p> <p>386910576 292.31 0802094</p>
		<p>BOZZ <i>Dušas krāns</i></p> <p>388310576 224.76 0802095</p>

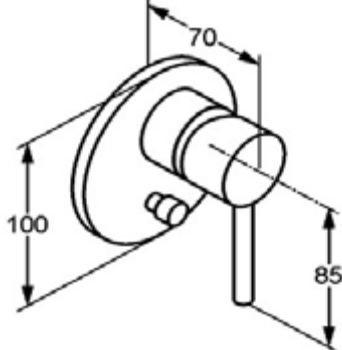
JAUCĒJKRĀNI AR SVIRAS ROKTURI

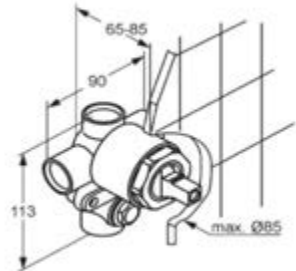
VEIKALS
EUR

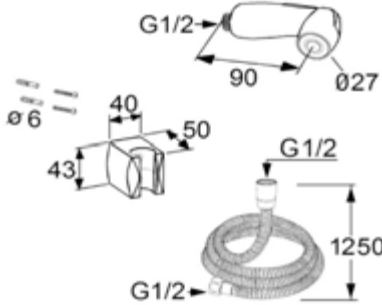
		BOZZ Dekoratīvā daļa iebūv.maisītājam 389250576	74.28 0810023
		BOZZ Iebūvējamā daļa 38826 N	71.58 0802041
		BOZZ Dekoratīvā iebūv.daļa v/d maisītājam 387160576	141.20 0810022
		BOZZ Iebūvējamā daļa v/d 38624 N	149.51 0802068
		BOZZ Bidetta komplekts 730420500	42.00 0839048









JAUCĒJKRĀNI AR SVIRAS ROKTURI

VEIKALS
EUR

		ZENTA	<i>Virtuves izlietnes krāns</i>		
		389730575	hroms	265.71	0802098
		389738675	melns/hroms	326.73	0802106
		389739175	balts/hroms		
		BINGOSTAR	<i>Virtuves izlietnes krāns</i>		
		428030578		305.80	0802076
		BINGOSTAR	<i>Virtuves izlietnes krāns ar izvelkamu dušu</i>		
		428510575		333.33	0802081
		SCOPE XL	<i>Virtuves izlietnes krāns</i>		
		339300575		124.17	0802100
		L-INE	<i>Virtuves izlietnes krāns</i>		
		428140577		175.20	0802097
		BINGO STAR S	<i>Virtuves izlietnes krāns</i>		
		468030578		251.70	0802120

JAUCĒJKRĀNI AR DIVIEM ROKTURIEM

VEIKALS

					<i>Izlietnes krāns</i>
	598	14.54	ORCHIDEA	0101056	
					<i>Izlietnes krāns ar grozāmo izteku</i>
		14.02	612 (izteka 18x150)	ABS	0101091
		15.30		ORCHIDEA	0101092
		35.45		LIBERTY	0101095
		32.86	612/K (izteka 18x150)	ORCHIDEA	0101096
		40.84		LIBERTY	0101099
					<i>Izlietnes krāns ar grozāmo izteku</i>
		14.70	624 (izteka 18x200)	ABS	0101118
		16.41		ORCHIDEA	0101119
		36.51		LIBERTY	0101122
		33.97	624/K(izteka 18x200)	ORCHIDEA	0101123
		41.93		LIBERTY	0101126
					<i>Izlietnes krāns no sienas ar "S" izteku vienam ūdenim</i>
	18.36	652	ABS	0101188	
					<i>Izlietnes krāns ar "J" izteku vienam ūdenim</i>
	18.36	653 (izteka 16X150)	ABS	0101192	
	19.93	653.2 (izteka 16X200)	ABS	0101294	
					<i>Izlietnes krāns ar "U" izteku vienam ūdenim</i>
	18.36	654	ABS	0101196	
					<i>Izlietnes krāns vienam ūdenim</i>
	11.11	658	10 cm	ORCHIDEA	0101204
	11.80	656	11 cm	ORCHIDEA	0101200

JAUCĒJKRĀNI AR DIVIEM ROKTURIEM

VEIKALS

Keramiskas izlietnes krāns ar dušu



1050

EUR

89.34

89.34

PANTHER

RING

0102093

0102094

Keramiskas izlietnes krāns ar dušu (bez komplekta)

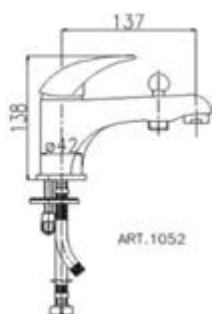
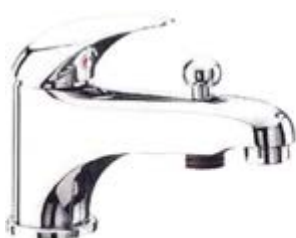

1052

79.15

79.15

PANTHER

RING

0102095

0102096

*Vannas krāns ar grozāmo izteku,
pārslēdzējs art. 0396*

1065.1-150

76.18

76.18

PANTHER

RING

0102284

0102205

1065.1-200

76.18

76.18

PANTHER

RING

0102140

0102141

1065.1-300

88.70

88.70

PANTHER







RING

0102143

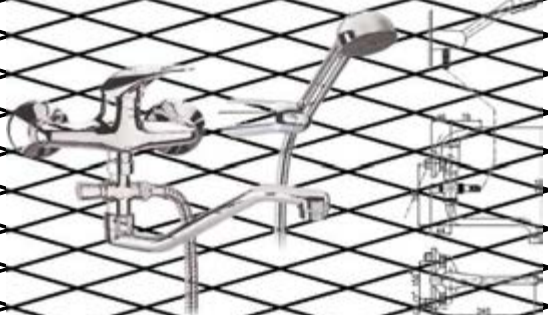
0102144

JAUCĒJKRĀNI AR SVIRAS ROKTURI

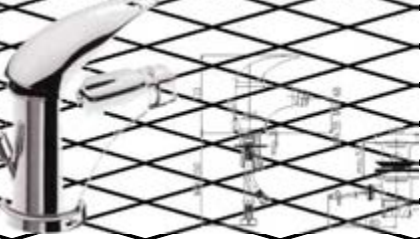
VEIKALS

	1065.1-075	76.18	PANTHER	0102221
		76.18	RING	0102247
	1066	90.21	PANTHER	0102015
		90.21	RING	0102086
	1069	35.66	PANTHER	0102033
		35.66	RING	0102066
	1069-130	47.88	PANTHER	0102224
		47.88	RING	0102225
	1070	17.00	PANTHER	0102036
		17.00	RING	0102077
	1076	11.51	PANTHER	0102099
		11.51	RING	0102098

JAUCĒJKRĀNI AR SVIRAS ROKTURI

VEIKALS

Izlietnes krāns ar izvelkamu izteku

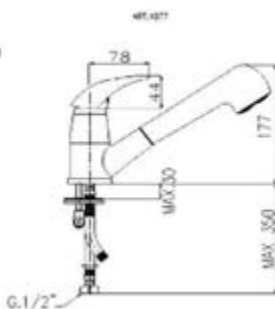

1077

EUR

73.67

73.67

PANTHER

RING

0102102

0102101



1079

51.40

51.40

PANTHER

RING

0102063

0102083

Izlietnes krāns, 130 mm

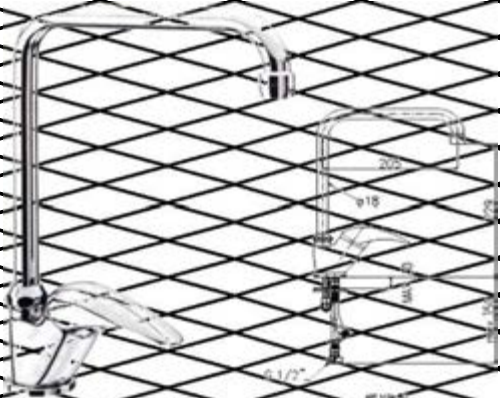

1079-67

43.52

43.52

PANTHER

RING

0102212

0102214

Virtuves izlietnes krāns

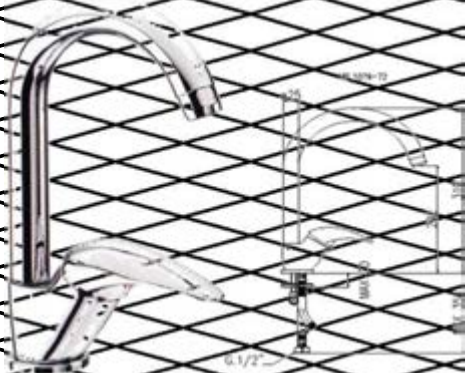

1079-72

52.86

52.86

PANTHER

RING

0102213

0102215

Virtuves izlietnes krāns

JAUCĒJKRĀNI AR SVIRAS ROKTURI

VEIKALS

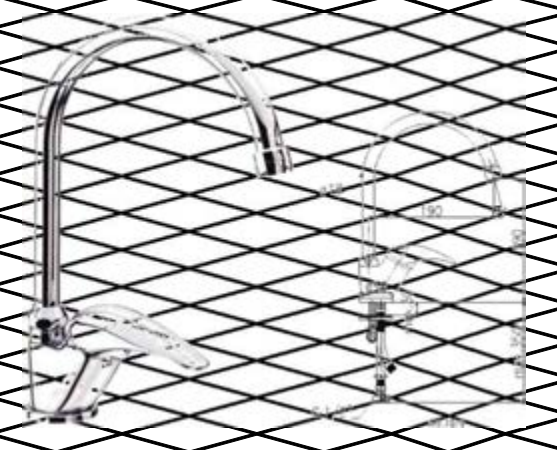
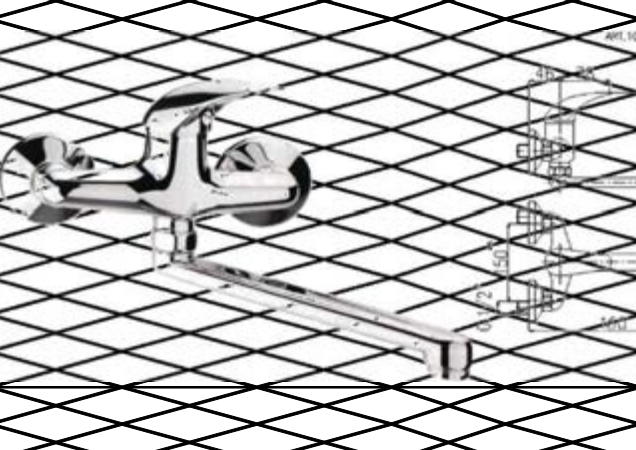
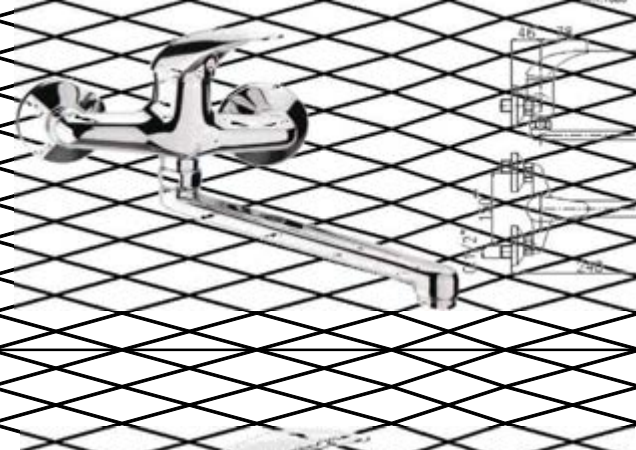
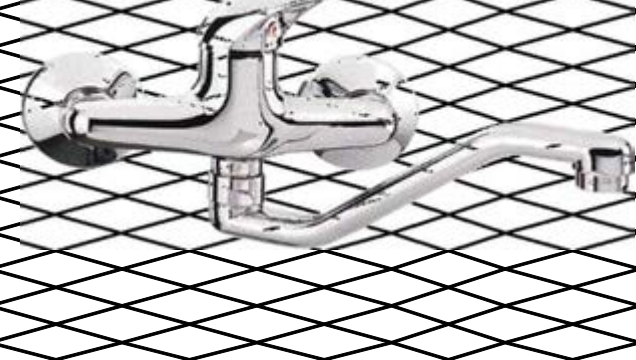
		<i>KĪTUVES IZLIETNES KRĀNS</i>	
	1079-G	41.86	PANTHER 0102706
		41.86	RING 0102708
		<i>IZLIETNES KRĀNS, 150 mm</i>	
	1080-150	51.24	PANTHER 0102152
		51.24	RING 0102153
		<i>IZLIETNES KRĀNS, 200 mm</i>	
	1080-200	51.24	PANTHER 0102051
		51.24	RING 0102065
		<i>IZLIETNES KRĀNS, 200 mm, LIEKTA</i>	
	1081	53.57	PANTHER 0102127
		53.57	RING 0102128

JAUCĒJKRĀNI AR SVIRAS ROKTURI

VEIKALS

Izlietnes krāna korpusi

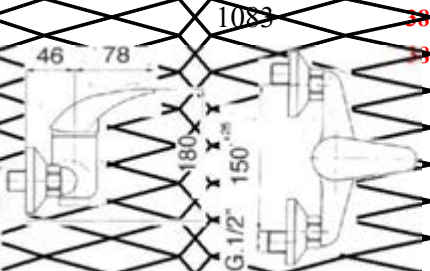
		1083	38.68	PANTHER	0102060
			13.68	RING	0102068

Divdaļīgs krāns, frizieru

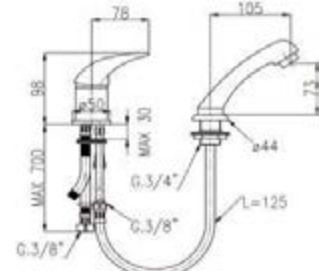
	MP480-10	81.24	PANTHER	0102288
				

Izlietnes krāns vienam ūdenim

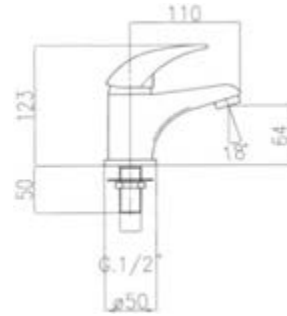
		1092	57.79	PANTHER	0102110
			65.08	RING	0102111

Virtuves izlietnes krāns, vienam ūdenim

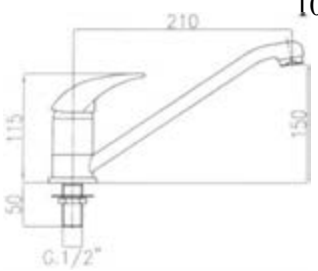
		1094	64.33	PANTHER	0102107
			64.33	RING	0102108

Virtuves izlietnes krāns ar dušu

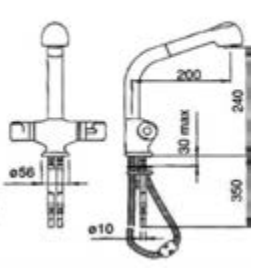
		211.93	93.50		0105005
			230.51		

VEIKALS

Keramiskās izlietnes krāns

EUR



ZEPHYR 8001

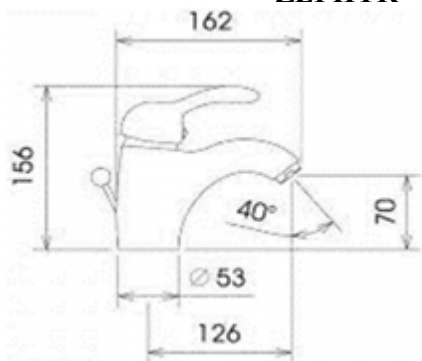

HR/MATĒTS **49.50** **0503016**

IZPĀRDOŠANA

40.91

Vairumcena bez PVN

Bidē krāns



ZEPHYR 8011

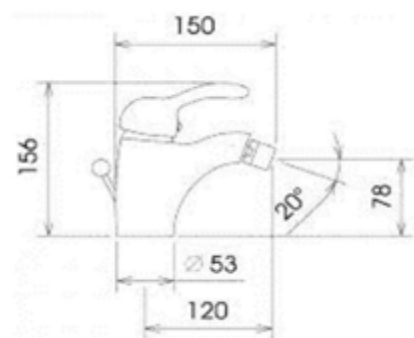

HR/MATĒTS **41.00** **0503029**

IZPĀRDOŠANA

33.88

Vairumcena bez PVN

HR/MATĒTS **49.00** **0503017**

IZPĀRDOŠANA

40.49

Vairumcena bez PVN

Vannas krāns ar dušas komplektu



ZEPHYR 8020

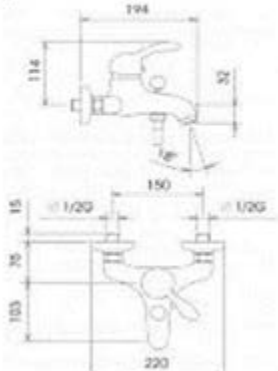

HR/KOKS **69.00** **0503018**

HR/MATĒTS **80.00** **0503019**

IZPĀRDOŠANA

57.02

66.12

Vairumcena bez PVN

Keramiskās izlietnes krāns



SPLIT 5000

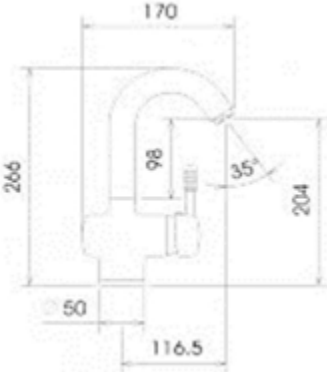

HR/MATĒTS **51.00** **0503013**

IZPĀRDOŠANA

42.15

Vairumcena bez PVN

VEIKALS

Keramiskās izlietnes krāns

EUR

MAXIMA 7000 HR/MATĒTS **70.00** 0503025

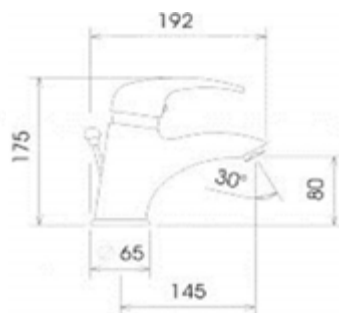

IZPĀRDOŠANA

57.85

Vairumcena bez PVN

Bidē krāns

MAXIMA 7010 HROMS **57.00** 0503021

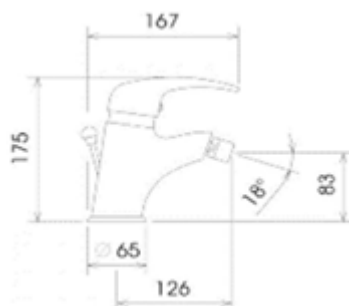

IZPĀRDOŠANA

47.11

Vairumcena bez PVN

Vannas krāns ar dušas komplektu

MAXIMA 7020 HROMS **83.00** 0503022

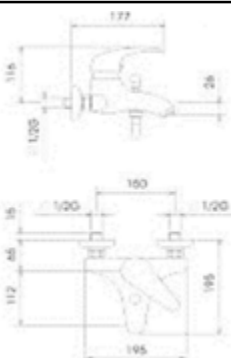

IZPĀRDOŠANA

68.59

Vairumcena bez PVN

Izlietnes krāns

MAXIMA 7100 HR/MATĒTS **201.51** 0503015

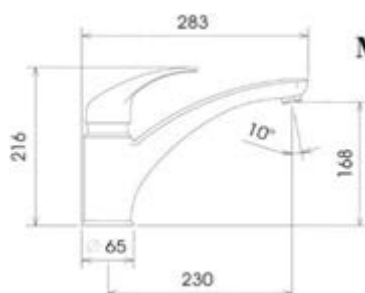

Izlietnes krāns (nolocāms)

SPLIT 5114 HR/MATĒTS **84.00** 0503014

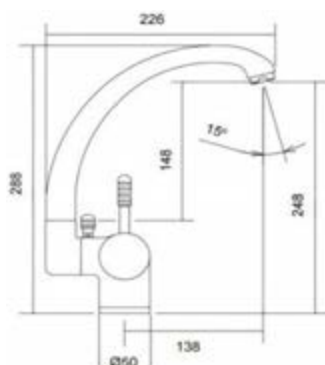

IZPĀRDOŠANA

69.42

Vairumcena bez PVN

VEIKALS

		<p>NEW PRO 42001 CSHROMS</p>	<p><i>Keramiskās izlietnes krāns</i></p>	<p>EUR 93.14</p>	<p>0502203</p>
		<p>NEW PRO 42011 CSHROMS</p>	<p><i>Bidē krāns</i></p>	<p>95.22</p>	<p>0502204</p>
		<p>NEW PRO 42020 S HROMS</p>	<p><i>Vannas krāns</i></p>	<p>129.37</p>	<p>0502205</p>
		<p>NEW PRO 42030 HROMS</p>	<p><i>Dušas krāns</i></p>	<p>108.68</p>	<p>0502208</p>
		<p>NEW PRO 42050 HROMS</p>	<p><i>Zemapmetuma dušas krāns</i></p>	<p>113.85</p>	<p>0502206</p>
		<p>NEW PRO 42050 R HROMS</p>	<p><i>Zemapmetuma vannas krāns</i></p>	<p>168.01</p>	<p>0502207</p>

VEIKALS

Vannas krāns ar dušas komplektu

SPLIT 5020 HR/MATĒTS **EUR 65.00** **0503012**

IZPĀRDOŠANA

53.72

Vairumcena bez PVN



TOWER TECH *Keramiskās izlietnes krāns*

12001 HROMS **136.61** **0502039**

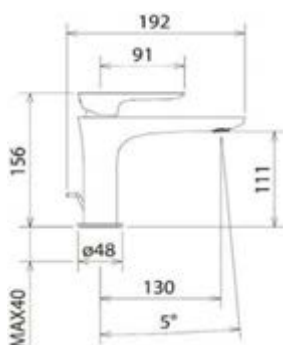

LAGHI *Keramiskās izlietnes krāns (augstais)*

44001 TC HROMS **202.66** **0502086**

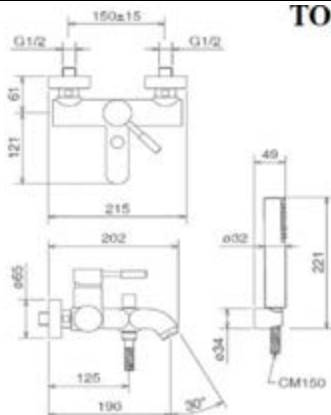

TOWER TECH *Vannas krāns ar dušas komplektu*

12019 HROMS **252.79** **0502013**

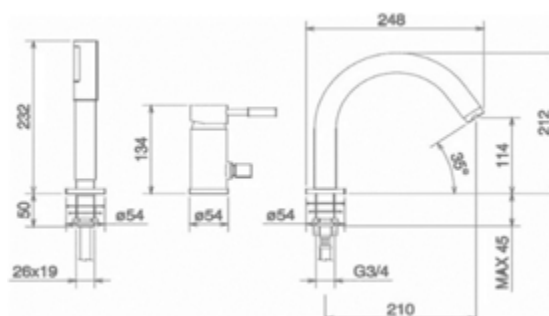

TOWER TECH *Krāns uz vannas malas 3-daļīgs*

12045EX HROMS **326.92** **0502053**

VEIKALS

Bidē krāns

EUR
138.62 **0502033**

TOWER TECH 12011 HROMS

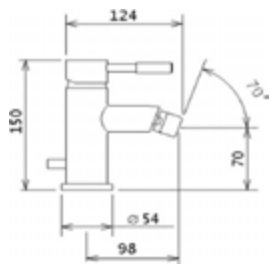

Izlietnes krāns

136.32 **0502113**

TOWER TECH 12600/28 HROMS

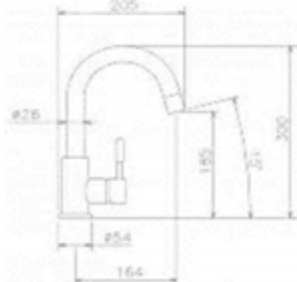

Izlietnes krāns no sienas (divdaļīgs)

159.08 **0502012**

TOWER TECH 12200 HROMS

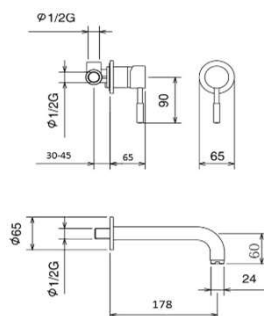

Izlietnes krāns

206.93 **0502044**

TOWER TECH 12191 HROMS

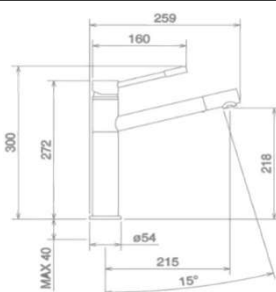

Zemapmetuma dušas krāns ar pārslēdzēju

135.61 **0502102**

TOWER TECH 12050/R HROMS

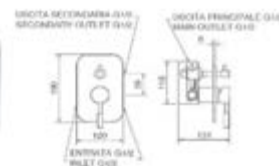
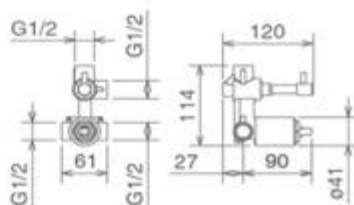

Dušas kabīnes krāns

146.67 **0502042**

TOWER TECH 12030 HROMS

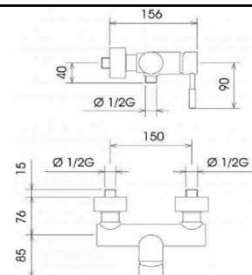

JAUCĒJKRĀNI AR SVIRAS ROKTURI

VEIKALS

Keramiskās izlietnes krāns ar noteci

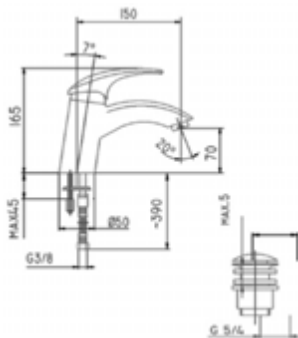

AMETYST 402-815-00 **91.92** 0703004

Dušas krāns

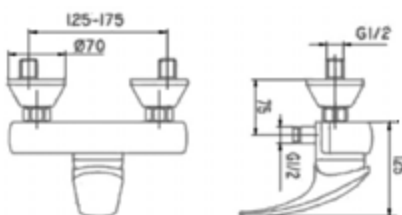

AMETYST 406-010-00 **43.00** 0703003

IZPĀRDOŠANA

Virtuves izlietnes krāns ar izvelkamu dušu

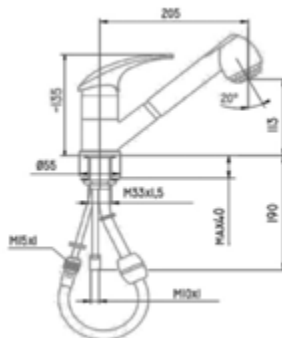

AMETYST 403-110-00 **48.00** 0703041

IZPĀRDOŠANA

Virtuves izlietnes krāns

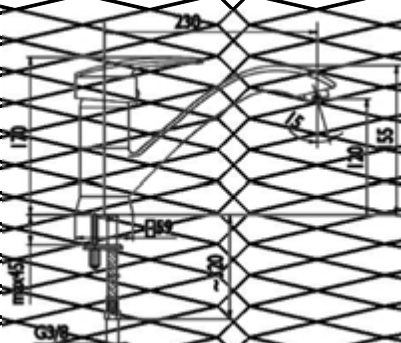

RUBIN 565-915-00 **75.68** 0703045

Dušas krāns



RUBIN 566-010-00 **34.00** 0703050

IZPĀRDOŠANA

JAUCĒJKRĀNI AR SVIRAS ROKTURI

VEIKALS

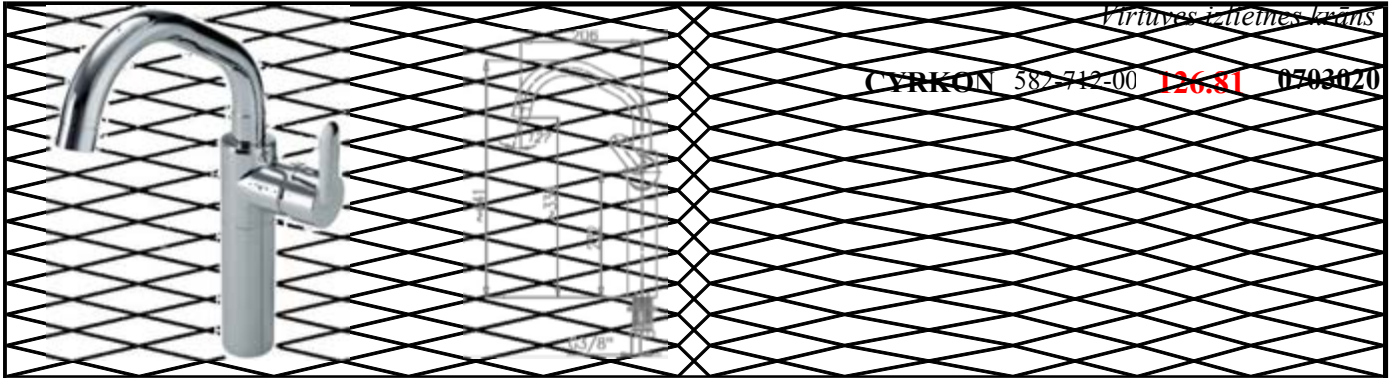

Virtuves izlieņes krāns

CYRKON 582-712-00 **126.81** 0703020

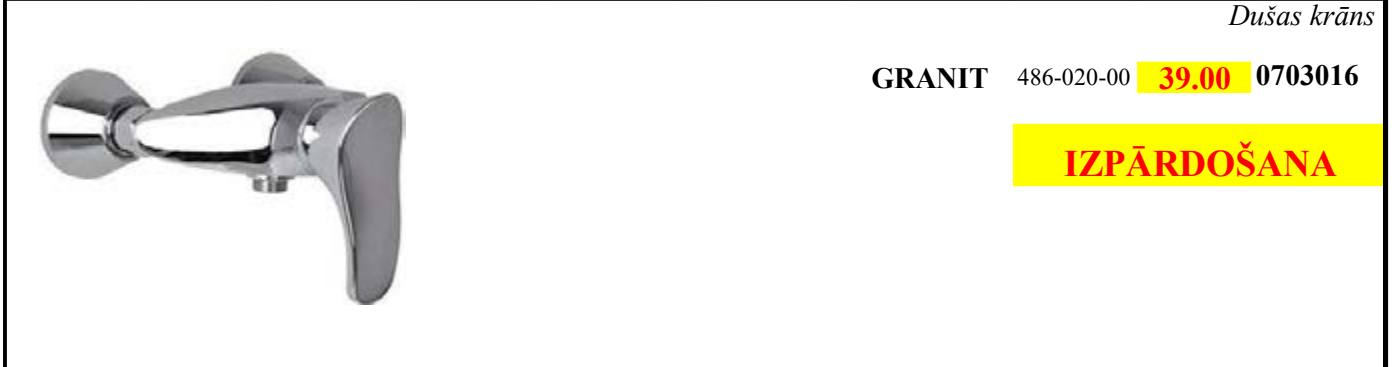

Dušas krāns

GRANIT 486-020-00 **39.00** 0703016

IZPĀRDOŠANA

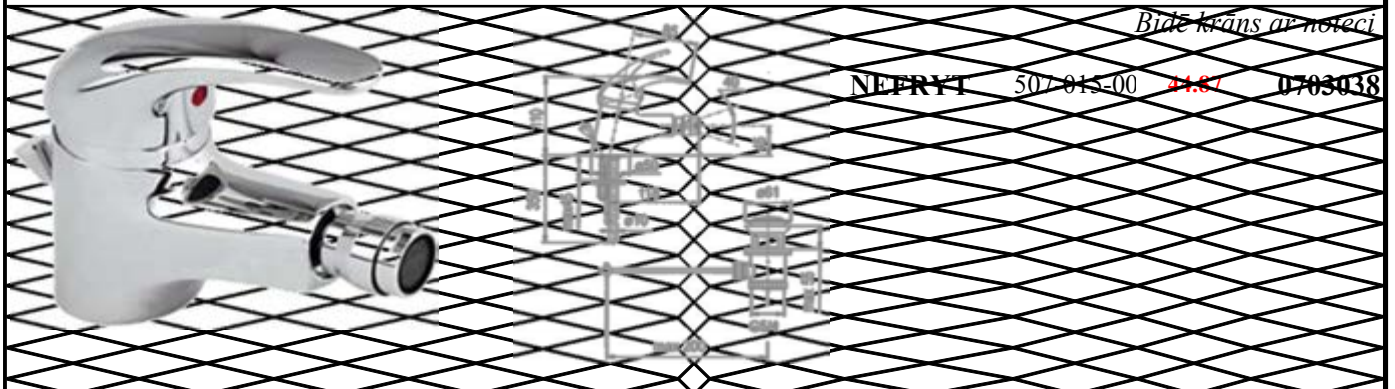

Bidē krāns ar noteci

NEFRYT 507-915-00 **41.87** 0703038

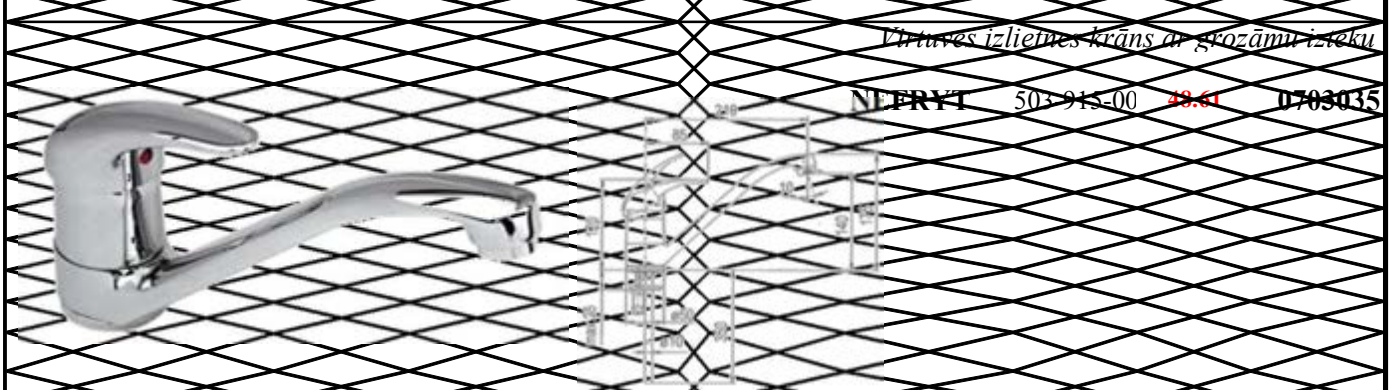

Virtuves izlieņes krāns ar grozāmu izteku

NEFRYT 507-915-00 **48.61** 0703035

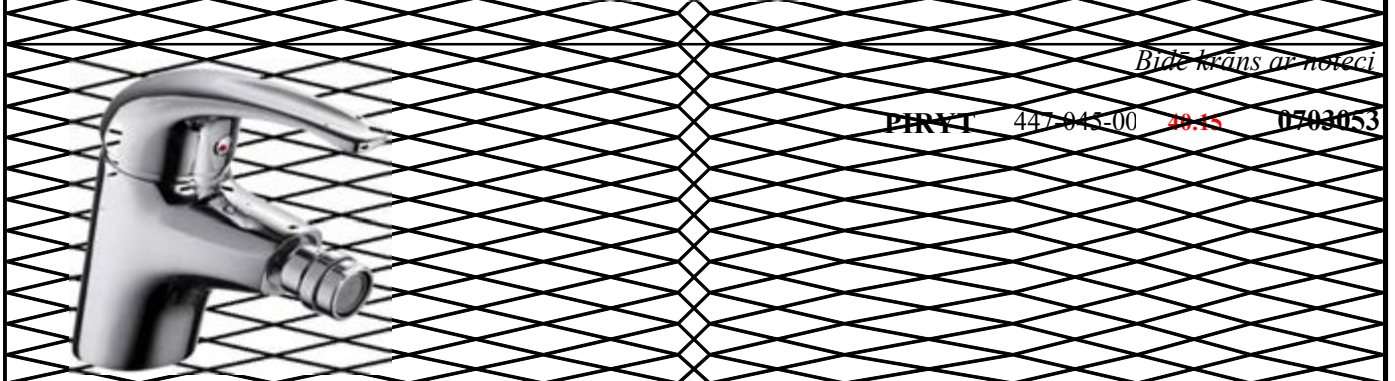

Bidē krāns ar noteci

PIRYT 447-945-00 **48.15** 0703053

JAUCĒJKRĀNI AR SVIRAS ROKTURI

VEIKALS

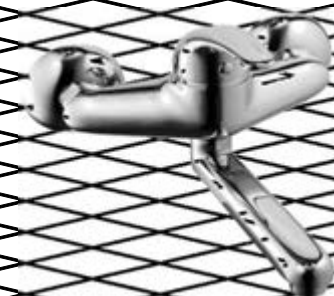
Duša krānsPIRYT 446-040-00 **54.85** 0703054*Vannas krāns ar grozāmu izteku, 350 mm*PIRYT 448-740-00 **88.75** 0703019*Virtuves izliešnes krāns no sienas*PIRYT 440-840-00 **63.01** 0703066*Virtuves izlietnes krāns no sienas*PIRYT 440-940-00 **34.00** 0703056**IZPĀRDOŠANA***Virtuves izlietnes krāns*PIRYT 443-140-00 **46.00** 0703058**IZPĀRDOŠANA**

JAUCĒJKRĀNI AR SVIRAS ROKTURI

VEIKALS

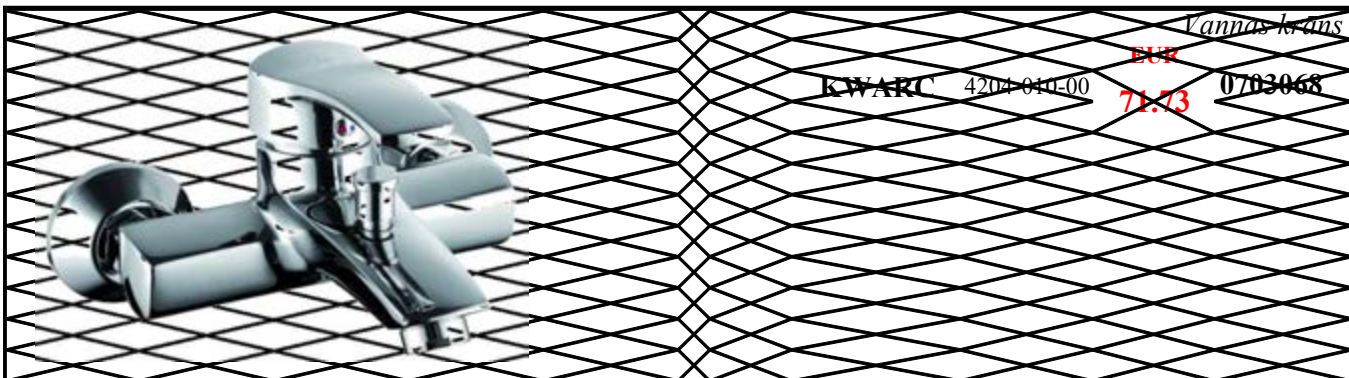
Vannas krāns

KWARC 4204-010-00

EUR

71.73

0703068

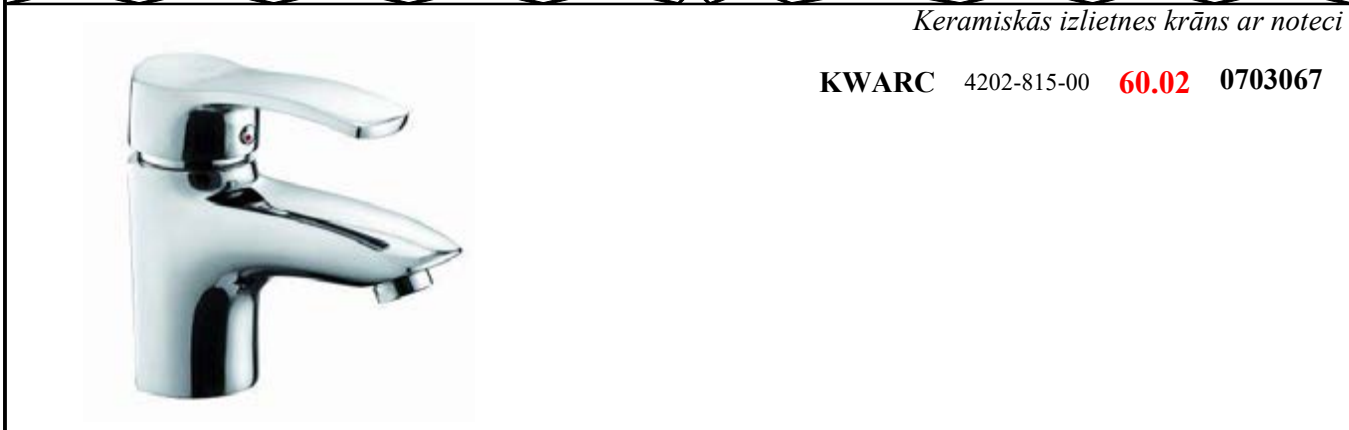
Keramiskās izlietnes krāns ar noteci

KWARC 4202-815-00

60.02

0703067

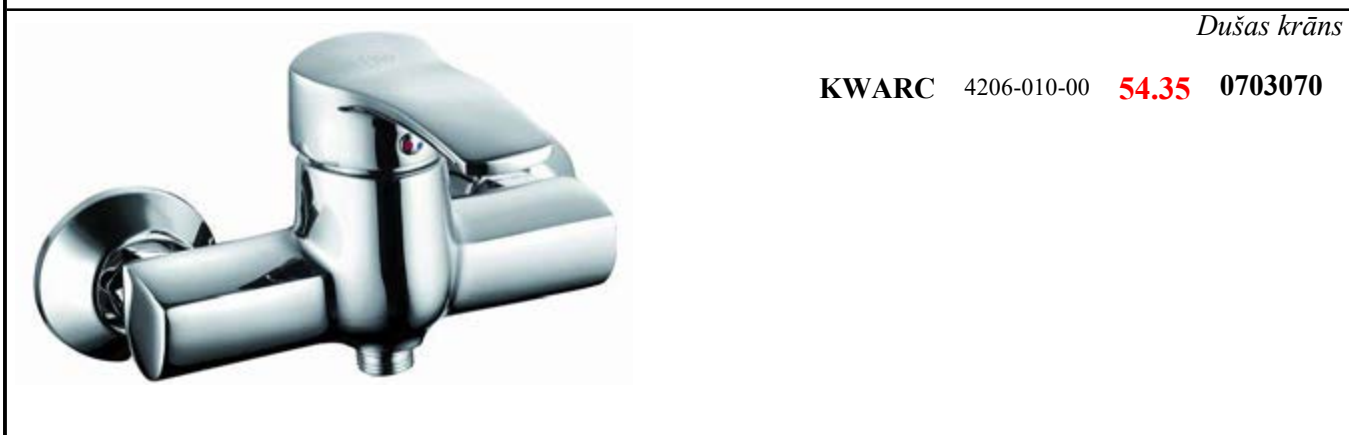
Dušas krāns

KWARC 4206-010-00

54.35

0703070

JAUCĒJKRĀNI AR SVIRAS ROKTURI

VEIKALS

	<p><i>Vannas krāns ar dušas komplektu</i></p> <p>FS 1135-21 33.42 1102031</p>
	<p><i>Vannas krāns ar dušas komplektu</i></p> <p>FS 1135-300 40.81 1102033</p>
	<p><i>Virtuves izlietnes krāns</i></p> <p>FS 1135-5 21.39 1102038</p>
	<p><i>Izlietnes krāns (izteka 150 mm)</i></p> <p>FS 1135-51 21.39 1102039</p>
	<p><i>Keramiskās izlietnes krāns</i></p> <p>FS 1135-6 20.69 1102040</p>
	<p><i>Bidē krāns</i></p> <p>FS 1135-8 20.32 1102042</p>
	<p><i>Bidē krāns</i></p> <p>FS 1435-8 10.50 1102062</p> <p style="text-align: center;">IZPĀRDOŠANA</p>

JAUCĒJKRĀNI AR SVIRAS ROKTURI

VEIKALS
Vannas krāns ar dušas komplektu

FS 9002-300 300 mm **45.52** **1103031**
Virtuves izlietnes krāns

FS 9002-5 **22.77** **1103005**
Izlietnes krāns (izteka 150 mm)

FS 9002-51 **25.94** **1103006**
Izlietnes krāns





FS9002-54 **34.09** **1103057**
Bidē krāns

FS 9002-8 **11.00** **1103008**
IZPĀRDOŠANA











VEIKALS

		<i>Dozators izlietnei, vienam ūdenim</i>		
	215/N	9-15 sec.	EUR 92.22	0508001
		<i>Virsapmetuma caurteces dozators</i>		
	415/SH	9-15 sec.	74.98	0508021
		<i>Dozators pisuāram</i>		
	420/UR	4-6 sec.	62.86	0508004
	420/SH	9-15 sec.	59.01	0508005
		<i>WC dozators</i>		
	310/B 3/4"	4-5 sec.	76.92	0508019
	310/D 1"	4-5 sec.	81.28	0508020
		<i>WC dozators</i>		
	315 1"	9-10 sec.	143.92	0508015

VEIKALS











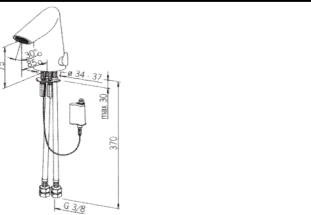

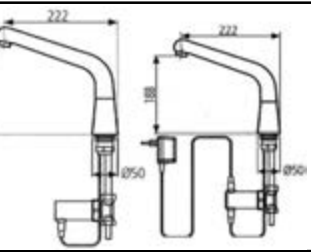
<i>Zemapmetuma dozators pisuāram</i>				
	410/UR	4-6 sec.	80.53	0508016
	410/SH	9-15 sec.	71.93	0508018
<i>Zemapmetuma dozators WC</i>				
	317 1"	4-6 sec.	141.21	0508012
<i>Pisuāra dozators ar trubiņu komplektā</i>				
	TE855	4-6 sec.	57.11	1008001
<i>Zemapmetuma dozators dušai</i>				
	TE30	9-15 sec.	69.09	1008002
<i>Virsapmetuma caurteces dozators dušai</i>				
	TE31	9-15 sec.	60.77	1008003

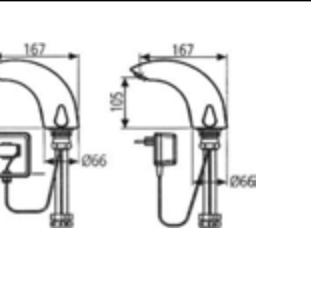
VEIKALS

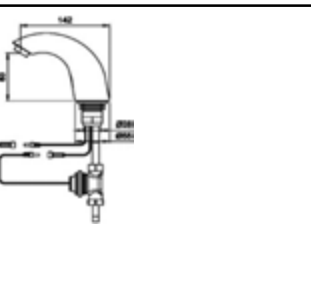
	TB1C				<i>Pievads pisuāra dozatoram</i> EUR 10.48	0510004
	TB2	14x38		4.73		0566001
					<i>Regulējams pievads dozatoram</i>	
	330C-B	3/4"x25		33.33		0510008
	330C-D	1"x30		36.68		0510007
					<i>Pievads dozatoram</i>	
	332C-B	3/4"x25		25.56		0510012
	332C-D	1"x30		26.66		0510011
					<i>Mehānisms dozatoram</i>	
	215V	4/6 sec.		34.71		0510013
					<i>Mehānisms dozatoram</i>	
	410 V 4/6	4/6 sec.		40.27		0510002
	410 V 10/15	10/15 sec.		40.27		0510014
					<i>Mehānisms dozatoram</i>	
	310V	4/5 sec		30.02		0510017
					<i>Vāciņš</i>	
	R11			1.83		0510018
					<i>Mehānisms dozatoram</i>	
	TE VI	4/6 sec.		34.42		1010001
					<i>Paredzēts art: TE15; TE16; TE53; TE255; TE855</i>	
					<i>Mehānisms dozatoram</i>	
	TE VI30	10/15 sec.		36.09		1010002
					<i>Paredzēts art: TE30 - TE31</i>	

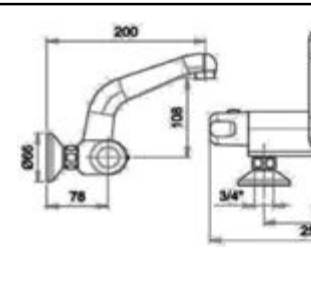

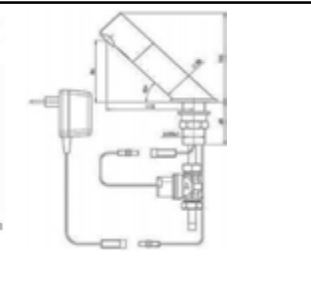

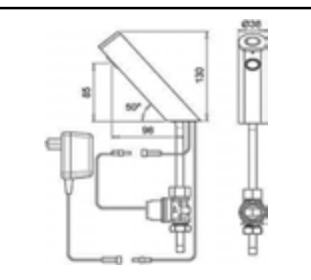

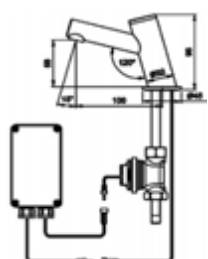

KRĀNI AR SENSORU

VEIKALS
EUR

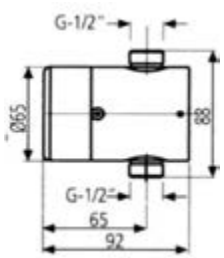
		<p><i>Izlietnes jaucejkrāns ar sensoru</i> (6V baterija montējama pie sienas)</p> <p>ORAS OPTIMA 130103019 218.03</p>
		<p><i>Izlietnes krāns ar grozāmu izteku</i> (9V baterija montējama pie sienas)</p> <p>DOLPHIN LB 1040 T 270160 174.85 1508001</p>
		<p><i>Izlietnes jaucejkrāns</i> (9V baterija krāna korpusā)</p> <p>SWAN 1000 B 252300 179.99 1508003</p>
		<p><i>Izlietnes krāns sagatavotam ūdenim</i> (9V baterija montējama pie sienas)</p> <p>EASY B 246010 146.05 1508011</p>
		<p><i>Izlietnes jaucejkrāns ar termostatu</i> (9V baterija krāna korpusā)</p> <p>APOLLO 1000 T 314200 241.70 1508015</p>
		<p><i>Izlietnes krāns vienam ūdenim</i></p> <p>TUBULAR 350700 146.05 1508020</p>
		<p><i>Izlietnes krāns vienam ūdenim</i></p> <p>TOUCH 225500 120.34 1508021</p>

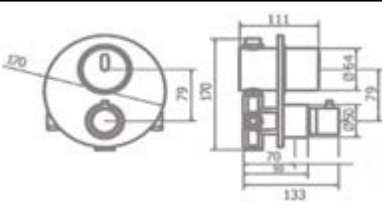
KRĀNI AR SENSORU

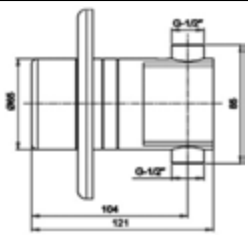
VEIKALS
 EUR

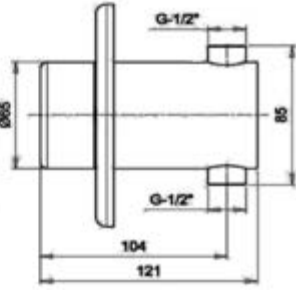
		<p>PERFECT TIME B</p>	<p>220100 87.42 1508014 (9V baterija montējama pie sienas)</p>	<p><i>Izlietnes krāns sajauktam ūdenim ar dozātoru</i></p>
		<p>NEPTUNE 1011 B</p>	<p>610261 113.14 1508005</p>	<p><i>Caurplūdes krāns dušai, sajauktam ūdenim (9V baterija krāna korpusā)</i></p>
		<p>NEPTUNE 1041 T</p>	<p>612241 262.27 1508019</p>	<p><i>Iebūvējams dušas krāns ar termostatu (9V baterija krāna korpusā)</i></p>
		<p>PERFECT TIME SH 1031</p>	<p>613700 133.71 1508017</p>	<p><i>Iebūvējams dušas krāns ar dozātoru (9V baterija krāna korpusā)</i></p>
		<p>NEPTUNE 1031</p>	<p>613200 149.14 1508013</p>	<p><i>Iebūvējams dušas krāns (9V baterija krāna korpusā)</i></p>
		<p>JUPITER 1031</p>	<p>134510 159.42 1508012</p>	<p><i>Pisuāra krāns (9V baterija krāna korpusā)</i></p>













REZERVES DAĻAS JAUCĒJKRĀNIEM

VEIKALS			
	EUR	Kasetne 35 mm (KLUDI)	
	19.61	75 605 00-00	0810040
	11.19	1130	0110103
	11.19	1140	0110104
	7.07	1140 SEDAL	7110085
	7.14	1130 SEDAL	7110056
	9.79	0200 SEDAL	7110057
	14.69	0201	0110107
	14.69	0200	0110121
	4.40	FC1101/35	1110031
	4.40	FC1101/40	1110037
	4.40	FC1002/35	1110030
	4.40	FC1002/40	1110034
	12.96	SQ200/15	0110203
	23.94	FC1962/35	7110068
	9.76	ST115	7110081
	3.57	671 1/2"	0110010
	3.37	671-E 1/2"	0110086
	8.16	058 1/2"	0110012
	3.92	RMG058 1/2"	7110005
	2.43	672 3/8"	0110011
	0.68	FC2102 3/8"	1110025

VEIKALS			
	5.74	RMG2053	7110092
	3.97	508 SLC 24x1	2010008
	3.97	512 SLC 22x1	2010007
	2.23	508 NP 24x1	2010006
	1.07	512 PL 22x1	7110069
	4.32	512 ECO 4.5 l/min 22x1	2110017
	4.32	6 l/min 22x1	2110016
	1.23	8 l/min 22x1	2110015
	2.36	10 l/min 22x1	2110014
	1.07	508 PL 24x1	7110055
	4.13	508 ECO 4.5 l/min 24x1	2110011
	4.13	6 l/min 24x1	2110010
	4.13	8 l/min 24x1	2110009
	1.23	10 l/min 24x1	2110008
	2.31	506 (hroms) 28x1	0110141
	1.81	508 (hroms) 24x1	0110100
	6.93	506 (zelts) 28x1	0110201
	6.50	508 (zelts) 24x1	0110199
	5.89	508 (13100) 18x1	0110185
	1.77	512 (hroms) 22x1	0110101
	5.97	512 (zelts) 22x1	0110200
	5.38	512 (13600) 20x1	0110186
	7.34	512 (13700) 16x1	0110190
	7.51	510 (hroms)	0110131
	16.23	510 (zelts)	0110136
	12.52	510 (futurist) 18x1	0110187
	6.05	FX508 LED	4810016
	IZPĀRDOŠANA		
	3.44	505	7110015
	6.54	507 ECO 6 l/min	2110007
	2.06	8 l/min	2110020

REZERVES DAĻAS JAUCĒJKRĀNIEM

VEIKALS EUR

	<i>Krāna uzgalis ar diviem režīmiem</i>	03630 NEW 15 cm	5.45	2010005
	<i>Krāna uzgalis ar diviem režīmiem</i>	03630 Universāls	3.02	2010003
	<i>Rokturis krānam ABS</i>	672/10	1.86	0110013
	<i>Rokturis krānam ORCHIDEA</i>	672/30	3.06	0110015
	<i>Rokturis krānam TRICORNO</i>	672/40	3.19	0110016
	<i>Rokturis krānam LIBERTY</i>	050	2.88	0110033
	<i>Uzlika ventilim</i>	052	1.13	0110034
	<i>Rokturis krānam APALŠ (MAGMA)</i>	RMG10	4.23	7110003
	<i>Rokturis krānam KRUSTA (Ķīna)</i>	FDH0039	1.35	1110021
	<i>Rokturis krānam KRUSTA (MAGMA)</i>	RMG11	4.87	7110009
	<i>Rokturis krānam JUPITS</i>	MG 035 40 mm	7.80	7110053
	<i>Rokturis krānam PANTHER</i>	1100 hroms	9.96	0110102

VEIKALS EUR

	<i>Rokturis krānam RING</i>	1108	9.96	0110111
	<i>Rokturis krānam LG</i>	MGMED 40 mm	10.29	7110071
	<i>Rokturis krānam VENERA</i>	MG64 35 mm	3.86	7110073
	<i>Rokturis krānam SATO</i>	MG 008 35 mm	5.62	7110049
	<i>Rokturis krānam URANS</i>	MG 049 35 mm	5.62	7110050
	<i>Rokturis krānam URANS</i>	MG 049 40 mm	7.80	7110054
	<i>Stiprinājuma uzgrieznis</i>	MGREZ VĪTNE	1.42	7110100
	<i>Stiprinājuma komplekts izlietnes krānam ar caurplūdi</i>	FXP0093	13.00	1110043
	<i>Stiprinājuma komplekts izlietnes krānam</i>	FXP0092	4.54	7110014
	<i>Stiprinājuma komplekts izlietnes krānam</i>	0114/A	3.36	0110035
	<i>Stiprinājuma komplekts izlietnes krānam (5E)</i>	0115/A 70 mm	6.93	0110159
		0116/A 110 mm	5.78	0110165
	<i>Stiprinājuma komplekts izlietnes krānam</i>	FXP0090	1.59	1110024
	<i>Stiprinājuma komplekts izlietnes krānam</i>	FXP0091	1.59	1110011

REZERVES DAĻAS JAUCĒJKRĀNIEM

VEIKALS

<i>Ekscentru uzgriežņi komplektā</i>			
	Labais R10251	EUR 6.60	0110155
	Kreisais MG R10251	4.10	7110065
<i>Uzgrieznis</i>			
	R11851	7.95	0110181
<i>Dekoratīvais riņķis 62 sērijas jaucējkrāniem</i>			
	RMG62	0.94	7110016
<i>Pārslēdzējs vannas krānam</i>			
	0518/A (met)	5.11	0110054
<i>Pārslēdzēja komplekts krānam MG2134</i>			
	REZMG213	9.85	7110045
<i>Pārslēdzēja mehānisms vannas krānam</i>			
	0519	4.38	0110048
<i>Pārslēdzēja mehānisms vannas krānam</i>			
	0520	2.46	0110074
<i>Pārslēdzēja mehānisms</i>			
	1050-MEH	17.16	0110137
<i>Pārslēdzēja mehānisms</i>			
	1050-MEH F	7.07	1110040
<i>Pārslēdzēja mehānisms</i>			
	1064-MEH	8.46	0110158
<i>Pārslēdzēja mehānisms Futurist sērijai</i>			
	13001	11.48	0110195
<i>Ekscentri (komplekts vienam krānam)</i>			
	655/40 (HR)	4.54	0110060
	655/40 (mat)	4.99	0110170







VEIKALS





<i>Ekscentri (komplekts vienam krānam)</i>			
	655/50	EUR 5.03	0110032
<i>Ekscentri (komplekts vienam krānam)</i>			
	655/60	6.42	7110007
	komplekta svars: 181 gr		
	655/92	10.33	7110046
	komplekta svars: 261 gr		
<i>Ekscentri uz vannas</i>			
	FTP0052	34.31	1110036
<i>Ekscentri garie (60 mm)</i>			
	655/55	25.84	0110076
<i>Dušas stienis (stacionārais)</i>			
	590	12.38	0110001
			<i>Garums 115 cm</i>
<i>Sietiņš stacionārajam dušas stienim</i>			
	740	2.56	0110049
<i>Pretvārsts krānam</i>			
	505	2.71	7110015
<i>Sienas stiprinājuma pagarinājums 2090/2095 garums 7 CM vecajam modelim</i>			
	REZMG2295	4.17	7110102
<i>Dušas stieņa FX250, apakšējā daļa garums 100 CM vecajam modelim</i>			
	FX250	28.27	4830014













REZERVES DAĻAS JAUCĒJKRĀNIEM

VEIKALS

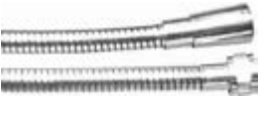
VEIKALS

RMG2056/D		<i>Duša jaucējkrānam MG2056</i>	
		15.00	4839048
RMG2057/D		<i>Duša jaucējkrānam MG2057</i>	
		13.00	4839049
655/J		<i>Izteka izlietnes krānam</i>	
		EUR	
	14x140	5.33	0110045
	14x162	7.19	0110061
	18x150	6.12	0110004
	18x200	7.66	0110005
RMG061	18x150	7.42	7110008
655/S		<i>Izteka "S" veida</i>	
			
	14x160	5.59	0110044
	18x200	6.12	0110006
	18x300	12.58	0110007
		<i>Izteka "S" veida</i>	
			
RMG060 F (18x300)		5.62	1110009
655/U		<i>Izteka "U" veida</i>	
			
	18x200	6.12	0110008
075		<i>Izteka "S" veida, liekta</i>	
			
	200 mm	26.88	0110123
	200 F	8.63	1110033
	300 F	12.22	1110032
	200 NT	5.45	7110079
	300 NT	5.68	7110078

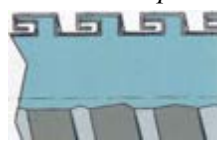

















068		<i>Izteka "S" veida, plakana</i>	
			
	150 mm	16.63	0110132
	200 mm	21.48	0110097
	300 mm	23.64	0110098
	200 F	8.63	1110027
	300 F	12.23	1110028
	200 NT	5.45	7110076
	300 NT	5.68	7110077
	350 NT	7.81	7110091
055		<i>Izteka jaucējkrānam 3255, 6255</i>	
			
	HROMS 233x165xØ24	10.88	7110067
RMG02555 IZT		<i>Izteka jaucējkrānam MG2555</i>	
	HROMS 210x180xØ24	14.69	7110090
070		<i>Izteka izlietnes krānam</i>	
			
	MATĒTS 180x130xØ25	9.99	0110189
404/C		<i>Izteka no izlietnes (apaļa)</i>	
			
		18.77	0510003

	<p>01001 (200) BL <i>Dubultais pinums ar konusu, hromēts</i></p> <p>01001 (200) <i>Dubultais pinums ar konusu, hromēts</i></p> <p>01001 (150) BL <i>Dubultais pinums ar konusu, ar vienu metrisko vītņi, hromēts</i></p>	<p>FLEXTON, ITĀLIJA</p> <p>6.80 0410040</p> <p>8.50 0410005</p> <p>5.40 0410038</p>
	<p>01001 (150) <i>Dubultā pinuma ar konusu, 1/2"x3/8"IV, hromēts</i></p> <p>01001 (200) <i>Dubultā pinuma ar konusu, 1/2"x3/8"IV, hromēts</i></p>	<p>FLEXTON, ITĀLIJA</p> <p>28.20 0410021</p> <p>34.10 0410022</p>
	<p>01003 (150) <i>Dubultā pinuma virtuves krānam, 1/2"x3/8"ĀV, hromēts</i></p> <p>01003 (200) <i>Dubultā pinuma virtuves krānam, 1/2"x3/8"ĀV, hromēts</i></p>	<p>FLEXTON, ITĀLIJA</p> <p>18.07 0410018</p> <p>26.73 0410019</p>
	<p>01006 (200) <i>Dubultā pinuma, hromēts</i></p>	<p>FLEXTON, ITĀLIJA</p> <p>6.20 0410012</p>
	<p>01010 (200) <i>Vienkāršais pinums ar konusu, hromēts</i></p>	<p>FLEXTON, ITĀLIJA</p> <p>6.10 0410015</p>
	<p>1014 (150) <i>Vienkāršais pinums, hromēts</i></p> <p>01014 (150) BL <i>Vienkāršais pinums ar vienu metrisko vītņi, hromēts</i></p> <p>1014 (150) <i>Vienkāršais pinums ar divām metriskām vītņēm, hromēts</i></p> <p>01014 (150) BL <i>Vienkāršais pinums ar divām metriskām vītņēm, hromēts</i></p> <p>01014 (200) <i>Vienkāršais pinums, hromēts</i></p>	<p>FLEXTON, ITĀLIJA</p> <p>4.00 0410013</p> <p>3.90 0410036</p> <p>3.70 0410011</p> <p>4.10 0410035</p> <p>5.80 0410016</p>
	<p>6105505-00 (125) <i>Plastikāta, ar diviem konusiem, "Logoflex"</i></p> <p>6105605-00 (160) <i>Plastikāta, ar diviem konusiem, "Logoflex"</i></p> <p>6105705-00 (200) <i>Plastikāta, ar diviem konusiem, "Logoflex"</i></p>	<p>KLUDI, VĀCIJA</p> <p>14.64 0810010</p> <p>9.48 0810001</p> <p>11.29 0810013</p>
	<p>0407420 (160-200) <i>Dubultā pinuma ar grozāmu konusu, elastīgs, hromēts</i></p>	<p>NICOLL, FRANCIJA</p> <p>40.90 1210002</p>
	<p>108 (150) <i>Vienkāršais pinums, hromēts</i></p>	<p>FLORY, ĶĪNA</p> <p>3.47 1110004</p>
	<p>710/10 (150) <i>PVC balts</i></p>	<p>FLEXTON, ITĀLIJA</p> <p>5.72 0110077</p>
<p>"BL" iepakojums ar kartona maliņu</p> 	<p>Dubultais pinums</p> 	<p>Vienkāršais pinums</p> 

		VEIKALS				VEIKALS	
	00010	EUR	<i>Bigmama</i> D11 cm	Hroms	23.80	0439070	
	00053		<i>Twister Happy</i> D6 cm	Hroms	9.99	0439021	
	00054		<i>Twister - 3</i> D6 cm	Hroms	13.48	0439022	
	00098		<i>Cobra - 1 Big</i> D6.5 cm	Hroms	9.99	0439004	
	003L2CR		<i>OAK</i>	Hroms	22.35	0439060	
	00511	EUR	<i>Liberty</i> D7 cm	Balts/hroms	36.72	0439085	
	RU1070		D2.5 cm	Hroms	5.49	0139030	
	D.5.10		<i>Frizieru</i> D2.5 cm	Hroms	24.06	0139035	
	00S29		<i>NORMALE</i> D6.2 cm	Hroms	11.39	0439086	
	00H59		<i>NORMALE</i> D20 cm	Hroms	244.44	0439033	
	00H91		<i>LIBERTY</i> D20 cm	Hroms	133.11	0439054	
	00H99		<i>LIBERTY</i> D30 cm	Hroms	256.41	0439051	
	00H74		<i>PRISMA PIU</i> D20 cm	Hroms	35.57	0439052	
	740		D9 cm	Hroms	3.40	0110049	

VEIKALS

VEIKALS

	Dušas galva (misina), kvadrāts FX19139 19 cm 36.55 1139018		A8000 Dušas turētājs misiņš 5.28 0439016
	Kronšteins dušas galvai 8200 20 cm 29.27 0439046		F5000 Dušas izvads ar klausules turētāju misiņš 1/2"x1/2" 24.06 0439049
	Kronšteins dušas galvai 90000 20 cm 21.54 0439047		F7000 Dušas izvads ar klausules turētāju misiņš 1/2"x1/2" 45.18 0439080
	Kronšteins dušas galvai FX94000 15 cm 17.02 4839042		6054705-00 Dušas izvads ar klausules turētāju misiņš 1/2"x1/2" 22.57 0839034
	Kronšteins dušas galvai 9F000 30 cm 70.47 0439058		02028 Izvads dušas klausulei, 30° misiņš 1/2"x1/2" 6.32 0439075
	Kronšteins dušas galvai (vertikālais) 73000 30 cm 119.37 0430099		MG589 Dušas pārslēdzējs 9.92 7110004
	Kronšteins dušas galvai 7G000 30 cm 42.46 0439083 35 cm 45.90 0439084 40 cm 48.20 0439048		MG589-MEH Mehānisms pārslēdzējam MG-589 3.16 7110075
	Kronšteins dušas galvai, vertikālais (40 cm) 9G000 20 cm 54.36 0439066 30 cm 58.52 0439059		589F Dušas pārslēdzējs 5.78 1110007
	2580 Dušas stiprinājums plastmasa HROMS 4.05 0139007		823-122-00 Dušas pārslēdzējs 8.99 0710006
	F4000 Dušas stiprinājums ar caurplūdi misiņš HROMS 13.55 0439044		

 <p><i>Dušas komplekts "ZENTA" DUAL SHOWER</i> KLUDI</p> <p>6167705-00 520.46 0830035</p> <p>Augšas galva D20 cm Rokas duša D8.4 cm Dušas pievads 150 cm Pievads jaucējkrānam 80 cm Stienis 130 cm Starp centriem 75 cm</p>	<p><i>Dušas stienis komplektā ar ziepju turētāju</i></p> <p>15000 19.00 0430009</p> <p>Stienis plakans 60 cm</p> 
 <p><i>Dušas komplekts "ZENTA"</i> KLUDI</p> <p>6063005-00 80.74 0830031</p> <p>Rokas duša D8.4 cm Dušas pievads 150 cm Stienis 60cm</p>	
 <p><i>Dušas stienis ar pievadu "A-QA" 90 CM</i></p> <p>6572005-00 88.07 0830038</p> <p>Dušas pievads 150 cm Stienis 90 cm</p>	
 <p><i>Dušas stienis</i></p> <p>12000 19.99 0430002</p> <p>Stienis plakans 60 cm</p>	

VEIKALS

VEIKALS

Dušas komplekts "Bali" Ø18-Twister happy
Hroms/zelts

32053 **36.00** 0430086



Rokas duša D6 cm
Dušas pievads 150 cm
Stienis 60 cm

**IZPĀRDOŠANA
VAIRUMCENA**

Dušas komplekts "Onda reflex" Ø25-Space age 80 cm

2B043 **48.00** 0430088



Rokas duša D6 cm
Dušas pievads 150 cm
Stienis 80 cm
Starp centriem 15.5 cm

**IZPĀRDOŠANA
VAIRUMCENA**

Dušas komplekts "Hawaii" Ø25-PASCAL

EUR
26239B10 **15.00** 0430067



Dušas pievads 150 cm
Stienis 60 cm

**IZPĀRDOŠANA
VAIRUMCENA**

Dušas komplekts "Hawaii" Ø25-BIMBO

26225B30 **20.00** 0430066





Dušas pievads 150 cm
Stienis 60 cm

**IZPĀRDOŠANA
VAIRUMCENA**

Izlietnes sifoni

VEIKALS

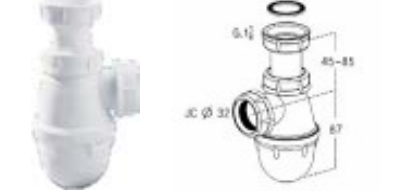
EUR

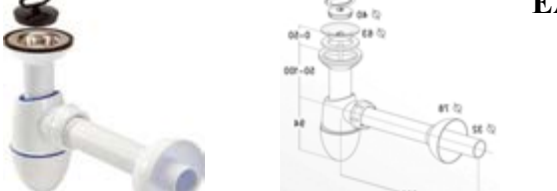
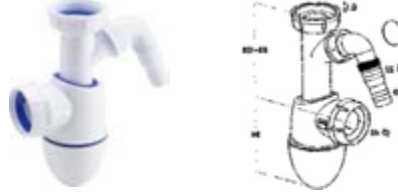
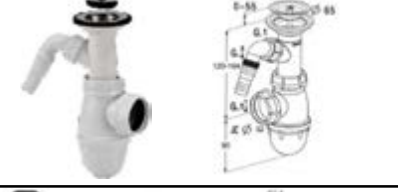
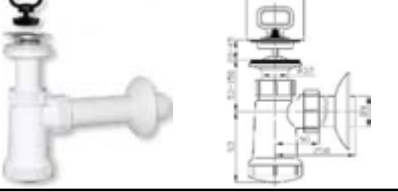
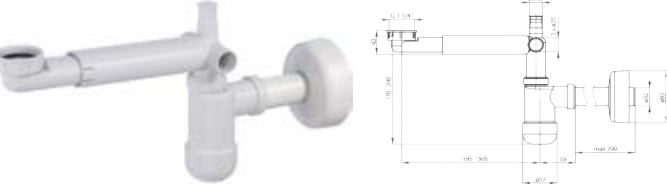
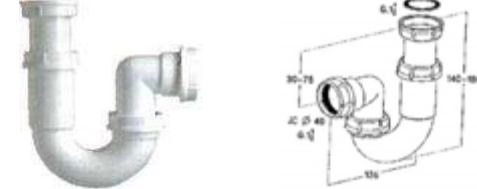







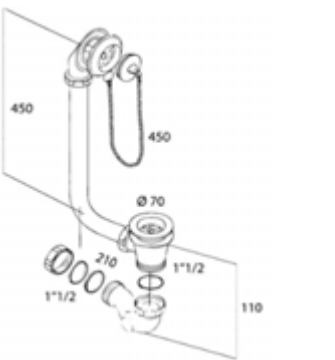

		<i>Izlietnes sifons</i>		
	1,1/4"x32	0201284	4.20	1250049
	1,1/4"x40	0201285	4.20	1250050
	1,1/2"x40	0224287	4.12	1250052
		<i>Izlietnes sifons</i>		
	1,1/4"x32	0201270	3.08	1250001
	1,1/2"x40	0224193	3.18	1250010
	1,1/4"x32x65	0201247	8.37	1250058
		<i>Izlietnes sifons</i>		
	1,1/4"x32	0202014	5.94	1250002
	1,1/2"x40	0202075	7.27	1250019
EASYPHON				
		<i>Izlietnes sifons ar noteci</i>		
	1,1/4"x32	0202122	10.22	1250025
	1,1/4"x40	0202138	10.24	1250015
	1,1/2"x40	0224217	10.58	1250040
		<i>Izlietnes sifons ar veļas mašīnas pieslēgumu</i>		
	1,1/4"x1,1/4"	0201302	5.97	1250044
	1,1/4"x1,1/2"	0201303	5.98	1250045
	1,1/2"x1,1/2"	0224360	6.42	1250016
		<i>Izlietnes sifons ar veļas mašīnas pieslēgumu un noteci</i>		
	1,1/2"x65	0202071	9.93	1250046
		<i>Izlietnes sifons ar noteci</i>		
	1,1/4"x32	EU0N332	4.86	6850043
	1,1/4"x40	EU0N342	4.86	6850044
		<i>Sifons izlietnei bez noteces ar nobīdi (teleskopisku)</i>		
	1 1/4x32	NHC_633K	21.00	8240005
		<i>Izlietnes sifons</i>		
	1,1/2"x40	0204460	5.77	1250030

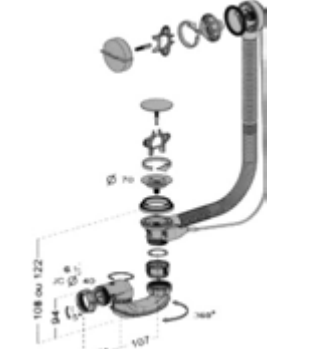
		<i>Savienojums dubultai izlietnei ar veļas mašīnas pieslēgumu</i>	1,1/2"x40	0204981	7.91	1250012
		<i>Komplekts sifona pievienošanai ar nobīdi</i>	1,1/4"x1/4"	0201011	7.67	1250062
		<i>Komplekts sifona pievienošanai ar nobīdi</i>	1,1/2"x1/1/2"	0204183	6.41	1250061
		<i>Pārplūde metāla izlietnei</i>	1,1/2"x70	0204015	8.37	1250017
			1,1/2"x114	0204123	16.52	1250055
		<i>Pārplūde metāla izlietnei Ø115</i>	1,1/2"x115	EDVA130	15.35	1250042
		<i>Pārplūde keramiskai izlietnei</i>	1,1/4'	0201152	9.11	1250043
		<i>Pārplūde metāla izlietnei Ø114, universāla</i>	1,1/2"x114	0224506/1	26.05	1250068
		<i>Izlietnes sifons ar pārplūdi Ø70</i>	1,1/2"x70	0204315	11.49	1250018
		<i>Dubultās izlietnes sifons ar veļas mašīnas pieslēgu</i>	1,1/2"x50	33 120 ED70440	23.76	6850013
		<i>Izlietnes sifons</i>	1,1/2"x50	31 206 EM26451	6.83	6850014
		<i>Izlietnes sifons ar noteci</i>	1,1/2"x40/50x70	ED20451	9.71	6850005
		<i>Izlietnes sifons ar veļas mašīnas pieslēgu</i>	1,1/2"x40/50	31 209 EM36451	8.09	6850004
		<i>Izlietnes sifons ar veļas mašīnas pieslēgu un noteci</i>	1,1/2"x40/50x70	ED30451	9.77	6850009

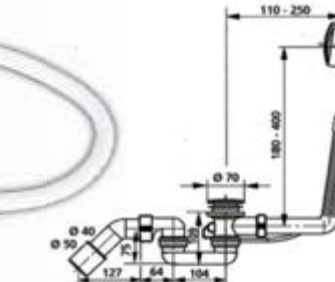
Sifoni vannām

VEIKALS

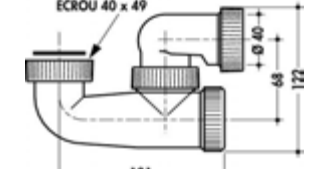
EUR

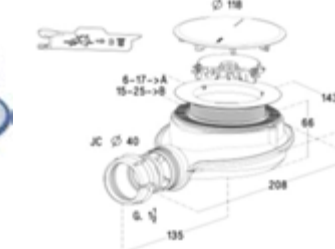
		<p><i>Sifons vannai ar ķēdi (hromēts)</i></p> <p>1,1/2"x40</p>	<p>0505040</p>	<p>164.13</p>	<p>1240004</p>
		<p><i>Sifons vannai, automātiskais "EASYBAIN"</i></p> <p>1,1/2"x40x70</p>	<p>0203617</p>	<p>37.10</p>	<p>1250056</p>
<i>Troses garums 100 cm</i>					
		<p><i>Sifons vannai</i></p> <p>1,1/2"x40/50</p>	<p>0203562</p>	<p>12.63</p>	<p>1250014</p>
		<p><i>Traps vannas sifonam ar izplūdes cauruli</i></p> <p>1,1/2"x40/50</p>	<p>0203059</p>	<p>8.61</p>	<p>1250032</p>
		<p><i>Sifons dušvannai (īsais)</i></p> <p>1,1/2"x11/2"</p>	<p>0203011</p>	<p>4.51</p>	<p>1250060</p>
		<p><i>Sifons ar revīziju</i></p> <p>1,1/2"x11/2"</p>	<p>0203008</p>	<p>8.60</p>	<p>1250013</p>
		<p><i>Sifons dušvannai (magnētiskais)</i></p> <p>1,1/2"x40</p>	<p>0205800</p>	<p>37.65</p>	<p>1250066</p>

Sifoni dušvannām











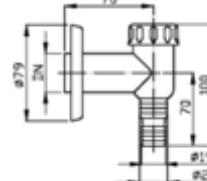

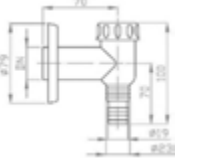



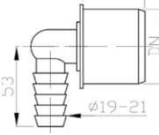

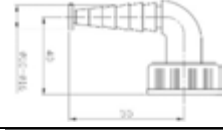

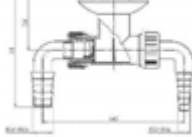
VEIKALS

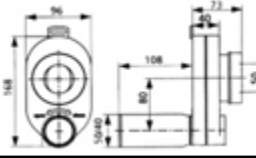
EUR

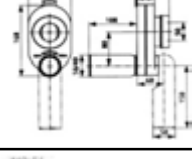
	<i>Sifons dušvannai ar dekoratīvo korķi Ø90</i>	1,1/2"x40/50	0205703	49.91	1250039
	<i>Sifons dušvannai ar korķi Ø70</i>	1,1/2"x40/50	0205374	11.07	1250034
	<i>Sifons dušvannai ar automātisko korķi "Cloc-Clic"</i>	1,1/2"x40/50	0205458	49.48	1250051
	<i>Sifons dušvannai ar dekoratīvo korķi ar hromētu ABS korķi Ø112</i>	Ø90x40/50	0205240	31.10	1250008
	<i>Sifons dušvannai ar dekoratīvo korķi Ø74</i>	Ø50-60x40/50	0205376	22.61	1250027
	<i>Sifons dušvannai ar dekoratīvo korķi ar hromētu ABS korķi Ø90</i>	Ø60x1,1/2"	0205301	11.51	1250033
	<i>Sifons dušvannai ar dekoratīvo korķi ar hromētu ABS korķi Ø120</i>	Ø90x1,1/2"	EWC0850	18.66	6850007
	<i>Sifons dušas paliktnim, zema</i>	90/40	EWCN942	29.50	6850041
	<i>Sifons dušavannai</i>		SIBH208	13.09	1250064

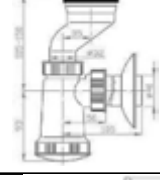
Sifoni

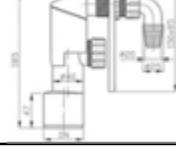
VEIKALS
EUR

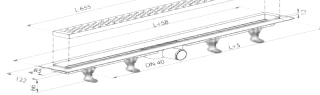
						<i>Sifons veļas mašīnai</i>
		EPVN000	6.90	6850006		
						<i>Sifons veļas mašīnai</i>
		EPVP000	3.82	6850022		
		DN50	8-25mm	UZ50000	4.72	6850028
		DN50	19-21mm	UZ50R00	4.72	6850029
						<i>Veļasmašīnas līkums</i>
		10-16 mm	EPP1230	1.46	6850030	
		18-23 mm	EPP1200	1.46	6850031	
		DN32	10-16/18-23	EPT3300	9.72	6850039
		DN32	18-23 mm	EPT3200	9.72	6850038
		DN50/40	31 407	ESO0550	23.21	6850002
		DN50/40	31 405	ESO0551	23.21	6850001
		DN40		ESO0341	9.64	6850042
		3/4"-1"x40/50	31 603	EPPC450	6.94	6850003
						<i>Grīdas ūdens noteka (ner. tērauds)</i>
		SZA5650	655 mm	102.79	6850021	
		SZE2850	855 mm	117.97	6850020	

Izlietnes sifoni

Sifons izlietnei "KLUDI"

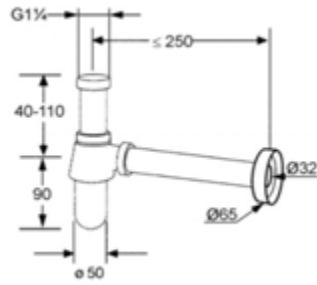
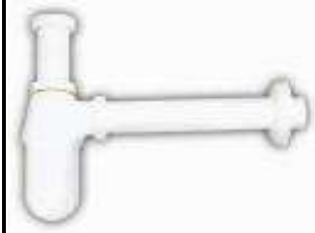

1,1/4"x32	HROMS	1010505-00	25.52	0840017
1,1/4"x32	BALTS	1010536-00	39.22	0840002

Sifons izlietnei ar nobīdi

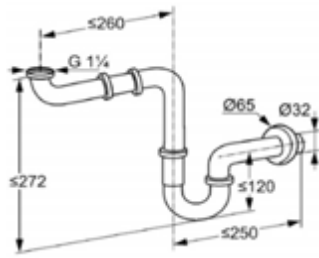

1,1/4"x32		1025505-00	46.69	0840018
-----------	--	------------	--------------	----------------

Sifons izlietnei "KLUDI"

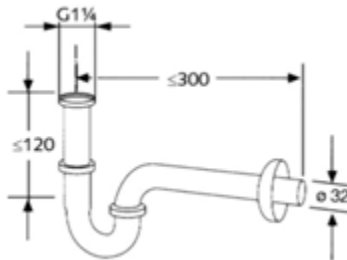

1,1/4"x32		1026505-00	26.32	0840016
-----------	--	------------	--------------	----------------

Sifons bidē "KLUDI"

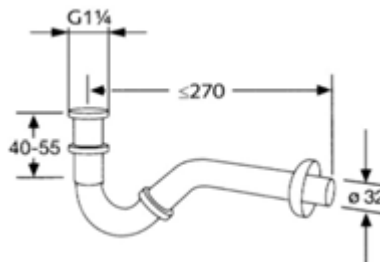

1,1/4"x32		1031105-00	26.21	0840014
-----------	--	------------	--------------	----------------

Sifons izlietnei

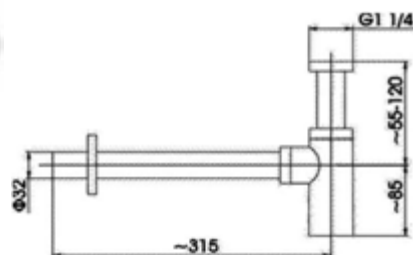

1,1/4"X32	MISIŅŠ	600-004	27.54	7140001
-----------	--------	---------	--------------	----------------

Izlietnes sifoni

VEIKALS
EUR

Sifons izlietnei

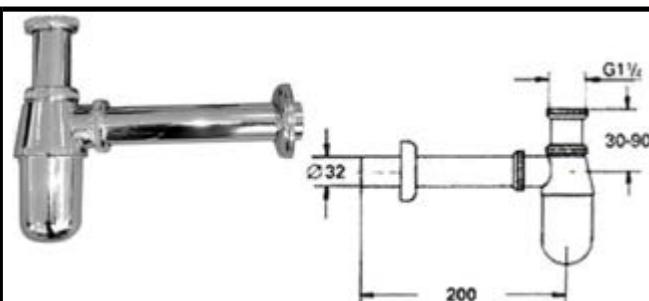
	1,1/4"x32	Cinks/alu	110Z	14.26	0340006
---	-----------	-----------	------	-------	---------

Sifons izlietnei ar noteci

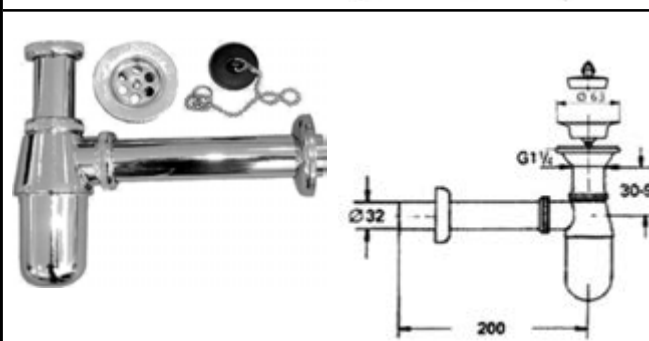
	1,1/4"x32	Cinks/alu	112Z	16.01	0340000
---	-----------	-----------	------	-------	---------

Sifons bidē

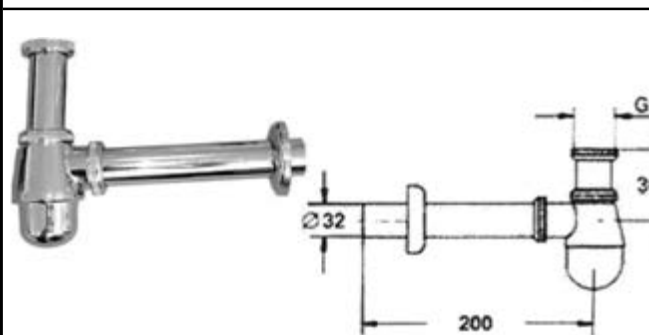
	1,1/4"x32	Misiņš	120	20.66	0340009
--	-----------	--------	-----	-------	---------

Sifons bidē ar noteci

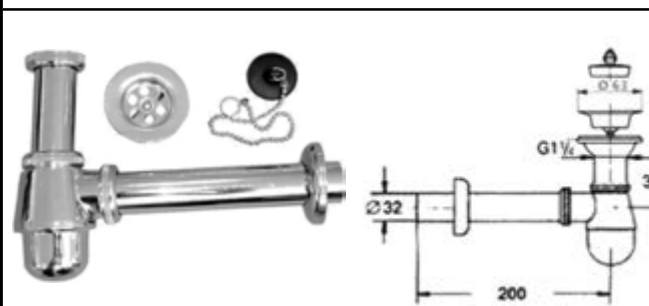
	1,1/4"x32	Misiņš	122	22.86	0340010
---	-----------	--------	-----	-------	---------

Sifons izlietnei bez noteces

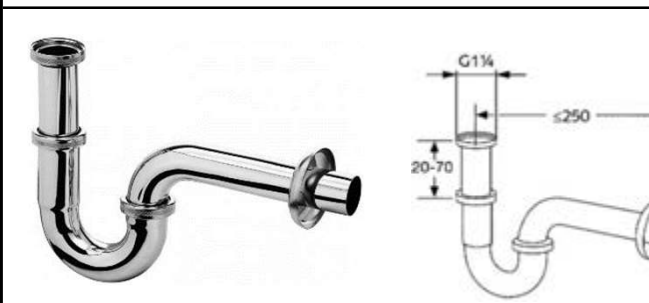
	1,1/4"x32	Misiņš	1025005-00	16.48	0840015
---	-----------	--------	------------	-------	---------

Starplika notecei

	0403069			18.20	1245006
---	---------	--	--	-------	---------

VEIKALS
EUR

VEIKALS
EUR

 <p>SFH10INCEX 99.86 1250067</p> 	<p><i>Traps grīdai ar hidroizolāciju</i></p> <p>150x150/110 61 10.74 7850002</p>
 <p>00x100x50 SIHJ10I 12.48 1250037</p>	<p><i>Traps grīdai ar vertikālu izplūdi</i></p> <p>92604/46 120x120/50 24.87 1750007</p>
 <p>100x100x50 831 4.34 1750001</p>	<p><i>Traps grīdai ar horizontālu izplūdi</i></p> <p>92604/47 120x120/50 26.53 1750006</p>
 <p>100x100x50 830 4.06 0350010 150x150x50 830 4.96 0350011</p>	<p><i>Sausais traps ar horizontālu izplūdi</i></p> <p>100x100/50 SI50C01 14.99 6850018</p>
 <p>100x100x1,1/4 917 26.42 0140005</p>	<p><i>Sausais traps ar vertikālu izplūdi</i></p> <p>100x100/50 SI5PC01 14.99 6850019</p>
 <p>1,1/2" 907 7.20 0140003</p>	<p><i>Universālais traps ar horizontālu izplūdi</i></p> <p>100x100/50 SI50C01UNI 19.72 6850023</p>
 <p>150x150/110 832 18.32 1750003</p>	<p><i>Lietus ūdens uztvērējs</i></p> <p>DN110 9200 11.00 1767003</p>
 <p>150x150/110 832 18.24 1750004</p>	<p><i>Ūdens novadīšanas kanāls</i></p> <p>1000mm x 130 mm 99101 23.80 1767004</p> 
 <p>150x150/110 60 8.03 7850001</p>	<p><i>Izvads kanālam</i></p> <p>99102 6.33 1767005</p>
	<p><i>Gala noslēgs kanālam</i></p> <p>99103 6.29 1767006</p>
	<p><i>Trapu reste, nerūs.tērauds.</i></p> <p>NSI50C0 100x100 mm 4.90 6850036 NSIA0C0 150x150 mm 12.15 6850037</p> 

Noteces

VEIKALS

		<i>Notece "Cloc-clic", universāla, derīga ar un bez pārplūdes</i>			
MELNA		1,1/4"x65x50(max)	1250UNIVE	15.27	0745001
		1,1/4"x65x50(max)	1250NERA01	20.83	7445005
		<i>Notece "Cloc-clic", ar pārplūdi</i>			
		1,1/4"x65x60(max)	600-352	18.43	1445001
		<i>Misiņa notece, zemā</i>			
		1,1/4"x65x15	201	4.99	0345000
		1,1/2"x80x15	201	4.11	7445001
		<i>Misiņa notece, augstā ar pārplūdi</i>			
		1,1/4"x63x50(max)	1042705-00	16.65	0845003
		<i>Misiņa notece, augstā bez pārplūdes</i>			
		1,1/4"x64x(29-50)	1042105-00	27.60	0845002
		1,1/4"x64x(8-22)	1042205-00	114.24	0845004
		<i>Notece krānam</i>			
		1,1/4"x63	655/95	9.72	7145001
		1,1/4"x63	655/95 zelts	10.29	0145001
		<i>Korķis vannas sifonam</i>			
			0411901	14.51	1245001
		<i>Sietiņš izlietnei, plastmasas</i>			
		35 mm	1209	0.47	7445002
		40 mm	1209	0.60	7445003

Noteces

		<i>Plastmasas notece, augstā</i>				
	1,1/2"x70x54	30.106	EV10000	4.57	6845004	
		<i>Plastmasas notece virtuves izlietnei</i>				
	1,1/2"X117X63	30.301	EDVA030	14.24	6845005	
		<i>Notece</i>				
	1,1/2"x70x40	385	EDV0000	4.03	0345008	
		<i>Notece, korķis ar ķēdīti</i>				
	1,1/2"x80x37	445		3.59	0345004	
		<i>Notece</i>				
	1,1/2"x70x33	30.105	EDV1010	3.39	6845001	
		<i>Notece keramiskai izlietnei, korķis ar ķēdīti</i>				
	1,1/4"x65x23	445	EUV0000	3.75	6845002	
		<i>Dekoratīvs noslēgs izlietnei hromēts</i>				
	Ø50mm	700	25	6.83	1245004	
		<i>Dekoratīvs noslēgs izlietnei balts</i>				
	Ø50mm	700/10	10	7.98	1245019	
		<i>Pārplūdes dekoratīvais riņķis izlietnēm (caurumam 25 mm)</i>				
	Ø24mm		6002010	2.75	1245008	
		<i>Korķis ar ķēdīti</i>				
	Ø31	930		2.12	1245009	
	Ø40	930		2.17	1245010	
	Ø45.5	930		2.17	1245011	
	Ø52	930		2.31	1245012	

Caurules un dekoratīvie šķīvīši sifoniem

VEIKALS
EUR

			<i>Hromēta caurule ar pāreju</i>	
	Ø32x125 mm	1049905-00	9.56	0845005
			<i>Hromēta caurule</i>	
	Ø32x200 mm	84501605-00	8.81	0845007
	Ø32x250 mm	84506605-00	10.92	0845008
	Ø32x300 mm	84502505-00	11.30	0845012
			<i>Hromēta, gofrēta caurule</i>	
	Ø32x350 mm	EMCR006	14.58	6845011
			<i>Hromēta caurule ar pievienojumu veļas mašīnai</i>	
	Ø32x200 mm x 3/4"	1046205-00	30.14	0845013
			<i>Hromēta uzmava</i>	
	Ø32x60 mm	1043105-00	7.22	0845014
			<i>Sifona caurule (220 mm)</i>	
	Ø32x220 mm	E001121	2.64	6845007
	Ø40x220 mm	E001021	3.00	6845008
			<i>Sifona caurule 45°</i>	
	45°x40/50	EV20000	1.71	6845009
			<i>Sifona caurule ar 2 piesl.v.maš.</i>	
	1.1/2"x260	EMP2642	6.94	6845010
			<i>Sifona caurule, grīdā</i>	
	Ø32	02 287	5.97	1245013
	Ø40	02 415	7.29	1245014
			<i>Sifona caurule, grīdā (hromēts)</i>	
	Ø32x680x220	84500805-00	50.55	0845015
			<i>Dekoratīvā rozete</i>	
	Ø32x90x20	81075405-00	10.56	0845017
			<i>Dekoratīvā rozete</i>	
	1/2"	697	0.53	0110204
			<i>Dekoratīvā rozete</i>	
	1/2"	697/10	0.83	0110207
	3/4"	697/10	1.21	0110208
			<i>Dekoratīvā rozete</i>	
	1/2"	697/20	0.66	0110209
			<i>Plastmasas pāreja (A-I)</i>	
	1,1/2"x1,1/4"	824	0.71	1245015
			<i>Plastmasas pāreja (A-I)</i>	
	1,1/4"x1,1/2"	824/A	0.71	1245016
			<i>Gredzenveida sifona pāreja</i>	
		125701	0.32	7445004

VEIKALS

EUR

VEIKALS

EUR

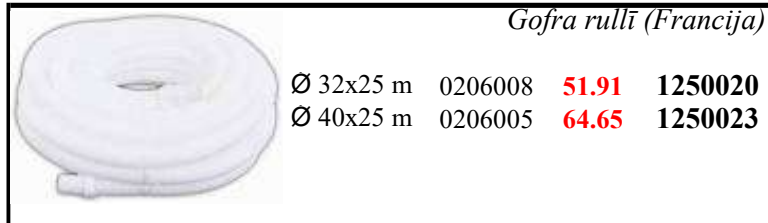

Gofra rullī (Francija)

Ø 32x25 m	0206008	51.91	1250020
Ø 40x25 m	0206005	64.65	1250023

Savienojums gofrai (uzgrieznis+pāreja+2 gumijas blīves)



Ø 32	0206012	1.80	1245017
Ø 40	0206009	1.96	1245018

Gofra (Francija)



Ø 32x650	0206001	3.80	1250003
Ø 40x650	0206002	3.88	1250006
Ø 32x900	0206064	4.49	1250004
Ø 40x900	0206065	5.39	1250007
Ø 32x1500	0206035	9.16	1250031
Ø 40x1500	0206067	10.71	1250022

Gofra ar plastmasas uzgriezni



1,1/4"x Ø 32/40	FPPG1004	1.61	7450004
1,1/2"x Ø 40/50	FPPG1005	1.66	7450005

Gofra ar metāla uzgriezni



1,1/4"x Ø 32/40	FPPG1010	1.85	7450002
1,1/2"x Ø 40/50	FPPG1006	2.17	7450003

Gofra (Itālija)



32/40	FPPG1007	1.62	7450006
40/50	FPPG1007	1.71	7450007

Gofra



DN40	CF40250	7.22	6850024
DN40	CF40500	9.30	6850033
DN50	CF50250	7.36	6850025
DN50	CF50500	9.70	6850035

Gofrēta uzmava



DN40	CF44250	7.50	6850026
DN40	CF44500	9.95	6850032
DN50	CF55250	7.78	6850027
DN50	CF55500	10.35	6850034

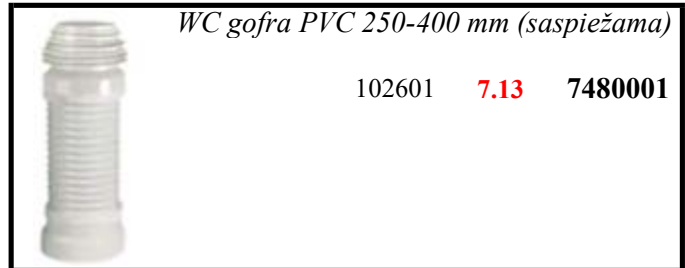

WC gofra PVC 250-400 mm (saspiējama)

102601	7.13	7480001
--------	-------------	----------------

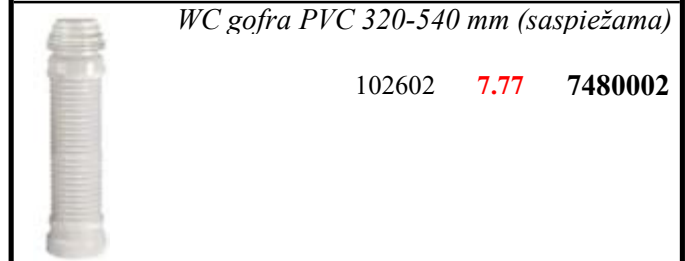

WC gofra PVC 320-540 mm (saspiējama)

102602	7.77	7480002
--------	-------------	----------------

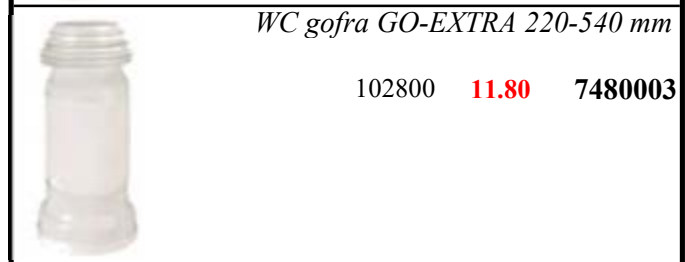

WC gofra GO-EXTRA 220-540 mm

102800	11.80	7480003
--------	--------------	----------------



WC gofra GO-MAGIC LUX 290-590 mm

102400	6.90	7480004
--------	-------------	----------------

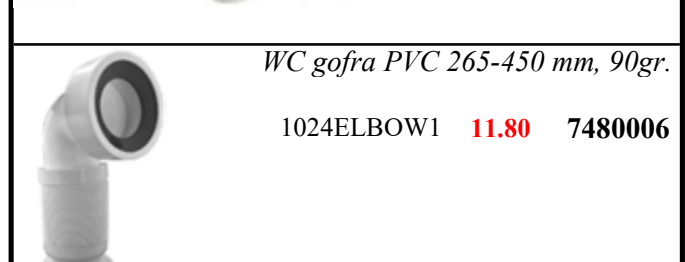

WC gofra PVC 265-450 mm, 90gr.

1024ELBOW1	11.80	7480006
------------	--------------	----------------

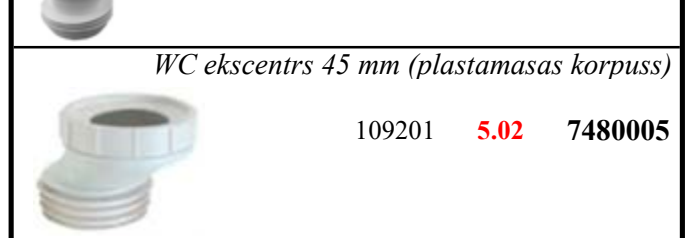

WC ekscentrs 45 mm (plastamasas korpuss)

109201	5.02	7480005
--------	-------------	----------------

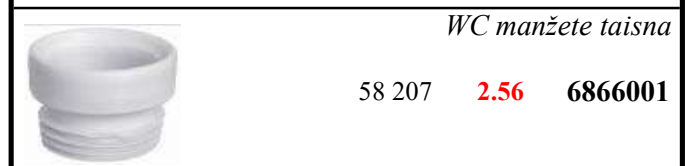

WC manžete taisna

58 207	2.56	6866001
--------	-------------	----------------

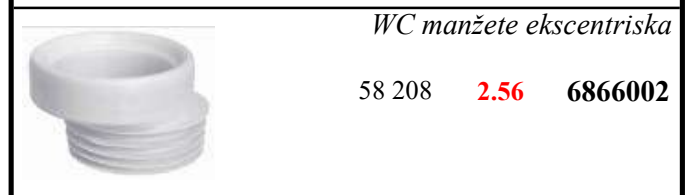

WC manžete ekscentriskā

58 208	2.56	6866002
--------	-------------	----------------

WC PIESLĒGI

VEIKALS
 EUR

WC līkumi

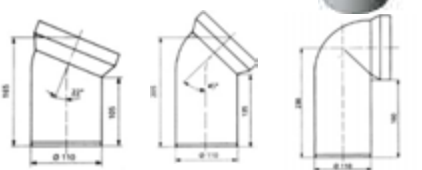
	22°	58 101	KK22000	4.36	6880003
	45°	58 102	KK45000	4.42	6880004
	90°	58 103	KK90000	4.67	6880005
					

WC līkums 90° ar atzaru DN50

	58 110			10.08	6880009
---	--------	--	--	--------------	----------------

WC pieslēgs

	150 mm	58 201	KP15000	4.90	6880006
	250 mm	58 202	KP25000	5.24	6880007
	400 mm	58 203	KP40000	6.81	6880008

WC ekscentrs

	58 206	KE15000		8.06	6880002
---	--------	---------	--	-------------	----------------

WC rozete

	110X170X41	58 301	KR00000	1.82	6880010
---	------------	--------	---------	-------------	----------------



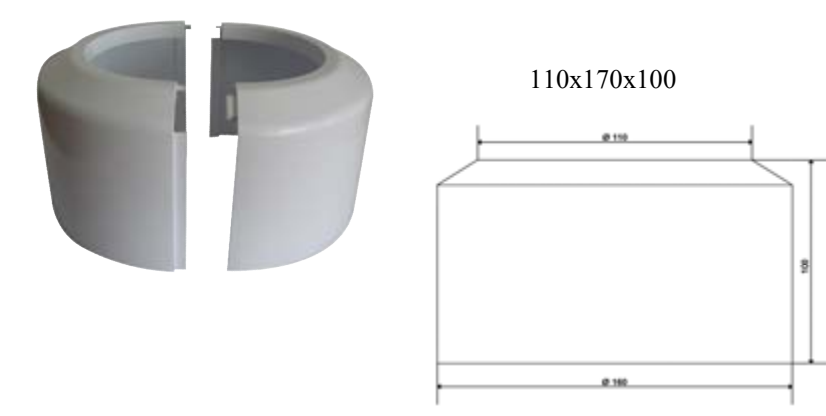





WC rozete







	110x170x100	KR1000	KR10000	3.92	6880011
---	-------------	--------	---------	-------------	----------------

Skalojamās tvertnes armatūra

VEIKALS
EUR











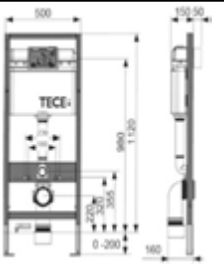

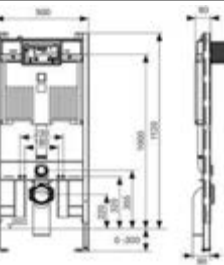
VEIKALS
EUR

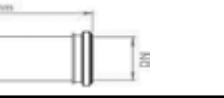
	<i>Skalojamās tvertnes armatūra universāla ar dubultpogu</i>		
	0702109	33.87	1271022
	0709413	25.05	1271026
	<i>Dubultpoga WC armatūrai</i>		
	0709336	11.43	1271014
	<i>Skalojamās tvertnes armatūra pieplūde no apakšas 3/8"</i>		
	0701052	21.02	1271015
	0701053	20.62	1271004
	<i>Skalojamās tvertnes armatūra pieplūde no sāna 3/8"</i>		
	0701058	21.02	1271016
	0701059	20.62	1271005
	0701122/PL	22.91	1271023
	<i>Skalojamās tvertnes armatūra universāla ar STOP - pogu</i>		
	0702109 PL	12.85	8871009
	<i>Skalojamās tvertnes armatūra universāla ar dubultpogu</i>		
	0702108 PL	13.12	8871002
	<i>WC armatūras poga ar STOP</i>		
	ZSK/305/0/L	4.07	8871023
	<i>Dubultpoga WC armatūrai</i>		
	ZSD/012/0/L	4.65	8871024
	<i>WC tvertnes uzpildes mehānisms pieplūde no apakšas 1/2" PL</i>		
	0701053 PL	6.42	8871005
	0701052 PL	5.75	8871008



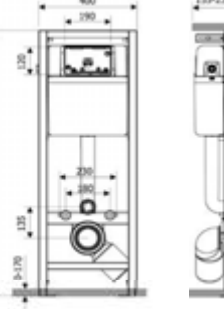
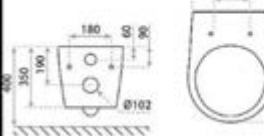

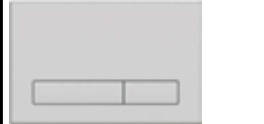









<i>Skalojamās tvertnes armatūra pieplūde no sāna</i>				
	7001OTT	1/2"	7.98	7471001
	7001OTT	3/8"	3.09	7471003
	<i>Pludiņš WC tvertnes uzpildes mehānismam</i>			
	1040000001	0.89	7471002	
	<i>WC tvertnes uzpildes mehānisms pieplūde no sāna</i>			
	600-95133	3.77	8871004	
	0701059PL	1/2" PL		
	600-98039	3.75	8871007	
	0701058PL	3/8" PL		
	<i>WC skalojamā tvertne, balta 600-5003195K</i>			
	95K	26.92	8871010	
	<i>WC skalojamā tvertne, balta 600-90001M99</i>			
	M99	25.40	8871011	
	<i>Skalojamās tvertnes armatūra M99</i>			
	600-56001	6.71	8871006	

VEIKALS



















EUR









		<p>Zemapmetuma rāmis podam ar baltu taustiņu</p> <p>9400400 256.87 4771009</p>
		<p>Zemapmetuma rāmis podam, īpaši plāns</p> <p>9300500 322.13 4771034</p>
		<p>WC īscauruļu komplekts, garums 30 cm</p> <p>9820214 36.38 4771010</p>
		<p>WC caurules pagarinājums DN90</p> <p>KP93510 13.25 6880013</p>
		<p>WC caurules pagarinājums DN44</p> <p>KP43000 5.75 6880014</p>
		<p>Zemapmetuma rāmis podam</p> <p>ZSP/M400/0/K 122.08 8871014</p> <p>Komplekts (rāmis + pods + taustiņš) ZSP/M400/kompl 271.55 8871019 (8871014+8277071+8871015)</p>
		<p>Piekaramais pods ARCTIC, Lavita</p> <p>110.40 8277071</p>
		<p>Izolācijas plāksne piek.podam, univers.</p> <p>350/A/108 4.86 8866000</p>
	<p>M16</p> <p>MELNA/MATĒTA SATĪNS</p>	<p>Taustiņš zemapmetuma rāmim</p> <p>350/PPC/100 32.99 8871026 350/PPS/015 30.93 8871027</p>
	<p>M05</p> <p>MATĒTS HROMS BALTA</p>	<p>Taustiņš zemapmetuma rāmim</p> <p>350/PPS/058 27.54 8871015 350/PPG/056 32.20 8871016 350/PPB/055 20.33 8871025</p>
	<p>M11</p> <p>MATĒTS HROMS BALTA</p>	<p>Taustiņš zemapmetuma rāmim</p> <p>SPP/111 29.87 8871017 SPP/112 34.65 8871018 SPP/110 22.65 8871021</p>







	VEIKALS	EUR	
	780		Gumijas manžetes
	32x26	0.71	4466016
	40x32x26	0.72	4466015
	50x32x26	0.74	4466013
	50x40	0.72	4466014
	780		Gumijas manžetes
	14x38	4.26	0566001
	32x75	1.81	4466002
	40x75	1.79	4466001
	50x75	1.92	4466011
	780		Gumijas manžetes
	40x60	1.25	0166012
	Gumijas manžetes, balta "STEDO"		
	780		
100x100	3.55	4466012	
	780-M		Gumijas manžete
	100x100	3.46	4466004
	780		Gumijas manžete "NEW PRO"
	melna 100x100	4.33	4466006
	780		Gumijas manžete "NEW"
	balta 100x100	4.32	4466005
	780		Gumijas manžete, universāla
	70x75x50x40	4.93	4466007
	780		Gumijas manžete
	D40	0.93	4466008
	D50	0.93	4466009
	997799		Svina plomba skaitītājiem
		0.21	2329001
	997809		Stieple plombēšanai (100m)
		27.12	2329002
	997798		Stieple plombēšanai (40cm)
		0.13	2329003
	Dzīvokļu skaitītājs aukstajam ūdenim		
	1/2"	25.85	4529001
	Dzīvokļu skaitītājs karstajam ūdenim		
	1/2"	25.85	4529004
	Dzīvokļu skaitītājs aukstajam ūdenim		
	3/4"	31.05	4529002

	VEIKALS	EUR	
	Dzīvokļu skaitītājs karstajam ūdenim		
	3/4"	31.05	4529006
	Māju ūdens skaitītājs aukstajam ūdenim		
	1/2"	54.93	4529015
	3/4"	57.85	4529003
	1"	83.78	4529005
	1,1/4"	143.24	4529007
	1,1/2"	181.01	4529010
	Māju ūdens skaitītājs karstajam ūdenim		
	1/2"	76.73	4529030
	3/4"	41.14	4529009
	1"	133.29	4529008
	1,1/4"	122.36	4529012
	1,1/2"	215.46	4529013
	Manometrs 0-6 bar, 63 mm 1/4"		
	4011 sāna	5.53	3829001
	Manometrs 0-10 bar, 63 mm 1/4"		
	4011 sāna	5.53	3829002
	Manometrs 0-10 bar, 55 mm 1/4"		
	GO PLAST sāna	5.40	7429001
	Manometrs 0-4 bar, 100 mm		
	4010 sāna	13.20	3829009
	Manometrs 0-6 bar, 100 mm		
	sāna	13.20	3829010
	Manometrs 0-10 bar, 100 mm		
	sāna	13.20	3829011
	Manometrs 0-16 bar, 100 mm		
	sāna	13.20	3829012
	Nepieciešama pāreja uz 1/2"		
	Manometrs 0-6 bar, 63 mm 1/4"		
	4011 aizmugures	5.06	3829003
		Manometrs 0-10 bar, 63 mm 1/4"	
4011 aizmugures		5.06	3829004
Manometrs 0-10 bar, 55 mm 1/4"			
	GO PLAST aizmugures		
		5.42	7429002
	Termomanometrs 0-6 bar, 80 mm, 1/2"		
	4013 aizmugures	16.78	3829006
	Termomanometrs 0-6 bar, 80 mm, 1/2"		
	4013 sāna	16.78	3829007
	Termometrs 120°C, 63 mm 1/2"		
	4012 aizmugures	7.10	3829005
	Termometrs 120°C, 63 mm stiprināms ar atsperi		
	4012 virsmas	7.77	3829008
	Redukcija manometram 1/2"xM20x1.5 izmantojama manometriem D100		
	607.402	2.77	0925307





















Skrūves un stiprinājumi

		GAB.		VEIKALS EUR	
100 <i>Metāla stiprinājums</i>					
	3/8"	14-18	100	0.72	1422049
	1/2"	20-25	100	0.74	1422034
	3/4"	25-30	100	0.83	1422035
	1"	31-36	100	0.88	1422036
	1,1/4"	40-44	50	0.88	1422037
	1,1/2"	50-58	50	0.90	1422039
	2"	60-64	50	0.93	1422038
	2,1/2"	75-80	50	1.98	1422040
	3"	85-92	25	1.97	1422041
	4"	110-118	25	2.29	1422043
5"	133-141	25	5.15	1422050	
6"	159-168	25	5.57	1422051	
10"	230-260	-	6.20	1422053	
111 <i>Metāla stiprinājums ar gumijas blīvi</i>					
	3/8"	14-18	100	0.91	1422064
	1/2"	20-25	100	0.80	1422024
	3/4"	25-30	100	0.81	1422025
	1"	31-36	100	0.87	1422026
	1,1/4"	40-44	50	0.97	1422027
	1,1/2"	44-50	50	1.06	1422028
	2"	60-64	50	1.14	1422029
	2,1/2"	75-80	50	1.61	1422030
	3"	85-92	25	2.60	1422031
	4"	110-118	25	1.98	1422033
5"	133-141	20	4.69	1422063	
6"	159-168	20	5.50	1422044	
<i>Komplekts radiatoru stiprināšanai ar atgaisotāju un korķi</i>					
	9824UK			8.19	1722058
783 <i>Skrūves izlietnei (2 gab.)</i>					
	8x100	50	1.44	1422018	
	8x120	50	1.53	1422019	
	8x150	50	1.60	1422020	
784					
	10x100	50	1.67	1422021	
	10x120	50	2.19	1422022	
	10x140	50	2.08	1422023	
250/A <i>Stiprinājums poda vākam (plastmasas)</i>					
				1.20	7422001
250/C <i>Stiprinājums poda vākam (hromēts)</i>					
				1.81	7422002
787 <i>Stiprinājumi WC skalojamai kastei</i>					
	105 mm			7.37	7822001
785 <i>Skrūves podam komplektā</i>					
	baltas	50	0.94	1422016	
	hromētas	50	0.97	1422017	
782 <i>Skrūves boileriem 2 gab.</i>					
	10x95	10	1.40	0122000	
<i>Klipšveida stiprinājums siltajām grīdām</i>					
	15-20 mm	01990	0.05	1722033	
	15-20 mm	01995	0.06	1722034	
011 <i>Plastmasas turētājs ar dībeli</i>					
	15mm	50	0.25	1422013	
	18mm	50	0.30	1422014	
	20mm	50	0.41	1422015	
	25mm	50	0.43	1422045	
	32mm	50	0.66	1422046	
	40mm	50	0.71	1422047	
9826FK <i>Klipšveida turētājs</i>					
	15-18	50	0.09	1722036	
	20-22	50	0.10	1722037	
	25-28	50	0.11	1722038	
	32-35	50	0.17	1722039	
9826ZK <i>Klipšveida turētājs (zaļš)</i>					
	20-22 mm	100	0.03	7622001	
	24-25 mm	50	0.03	7622002	
	32 mm	50	0.03	7622003	
9826AK <i>Klipšveida stiprinājums</i>					
	10	100	0.29	1722001	
	12	100	0.22	1722002	
	14-15	100	0.18	1722003	
	16-18	100	0.19	1722004	
	20-22	50	0.23	1722005	
	25-28	50	0.69	1722006	
	35	25	0.64	1722059	
9827AK <i>Klipšveida stiprinājums dubultais</i>					
	10	100	0.10	1722007	
	12	100	0.35	1722008	
	14-15	100	0.25	1722009	
	16-18	100	0.34	1722010	
	20-22	50	0.36	1722011	
	25-28	50	0.37	1722030	
35	25	0.88	1722060		
9826EK <i>Klipšveida stiprinājums</i>					
	15	50	0.26	1722012	
	16	50	0.26	1722013	
	18	50	0.27	1722014	
	20	50	0.28	1722015	
	22	50	0.30	1722016	
	25	50	0.34	1722017	
	28	50	0.34	1722018	
	32	50	0.53	1722019	
9827EK <i>Klipšveida stiprinājums dubultais</i>					
	15	40	0.37	1722020	
	16	40	0.61	1722021	
	18	40	0.45	1722022	
	20	40	0.71	1722023	
	25	40	1.02	1722025	

		GAB.	VEIKALS EUR	
9826BK		<i>Stiprinājums plastmasas caurulēm</i>		
	32	50	1.03	1722026
	40	40	1.01	1722027
	50	40	1.15	1722028
	75	40	1.25	1722061
	110	40	1.69	1722029
2020		<i>Izolācijas skava</i>		
			2.36	1722040
2009		<i>Skava caurulei (grīdas siltināšanai)</i>		
	100		9.62	7822002
	250		10.80	1722041
91230		<i>Takers skavas stiprināšanai</i>		
	1gb		260.86	1735010
01860P		<i>Cauruļu stiprinājums ar dībeļnaglu</i>		
	25mm	200	0.08	1722031
01970P		<i>Cauruļu stiprinājums ar dībeļnaglu dubults</i>		
	25mm	100	0.10	1722032
		<i>Āķītis ar dībeli</i>		
	04368 8mm	100	0.53	1422060
	04369 10mm	50	0.90	1422061
		<i>Vītņstienis</i>		
	8x1000mm	976-08X1	1.39	1422055
	8x2000 mm	976-08X2	3.86	1422066
	10090		1.58	1422056
	10x1000mm			
		<i>Uzgrieznis vītņstienim</i>		
	16002 8x24mm		0.23	1422057
	16004 10x30mm		0.44	1422058

		GAB.	VEIKALS EUR	
		<i>Savilcēji (nerūsējošs tērauds)</i>		
	8-16	50	0.36	1627001
	12-20	50	0.37	1627002
	16-24	50	0.40	1627003
	20-32	50	0.43	1627004
	25-40	50	0.41	1627005
	32-50	50	0.48	1627006
	40-60	50	0.48	1627007
	50-70	50	0.48	1627008
	60-80	50	0.61	1627009
	70-90	25	0.63	1627010
	80-100	25	0.70	1627011
	90-110	25	0.73	1627012
	100-120	25	0.75	1627013
	110-130	25	0.99	1627014
	120-140	25	1.03	1627015
	140-160	25	1.10	1627016
		<i>Savilcēji (nerūsējošs tērauds)</i>		
	23-25	10	1.37	1627017
	26-28	10	1.37	1627031
	29-31	10	1.37	1627018
	32-35	10	1.37	1627019
	36-39	10	1.48	1627034
	40-43	10	1.64	1627020
	44-47	10	1.87	1627021
	48-51	10	2.05	1627032
	52-55	10	2.27	1627033
	56-59	10	2.57	1627022
	60-63	10	2.97	1627023
	64-67	10	3.40	1627024
	68-73	10	3.54	1627025
	74-79	10	3.64	1627026
	80-85	10	3.76	1627027
	86-91	10	3.91	1627028
	92-97	10	4.04	1627029
	98-103	10	4.17	1627030
2215		<i>Dekoratīvais šķīvītis, jaucams (balts)</i>		
	15	100	0.29	1770001
	16	100	0.23	1770003
	18	100	0.23	1770002
	20	100	0.24	1770004
	22	100	0.23	1770005
	28	100	0.25	1770006
2215/C		<i>Dekoratīvais šķīvītis, jaucams (hromēts)</i>		
	15	100	1.37	1770007
	16	100	1.37	1770008
	18	100	1.39	1770009
	20	100	1.41	1770010
	22	100	1.43	1770011
	28	100	1.44	1770012
2220		<i>Dekoratīvais dubultais šķīvītis (balts)</i>		
	15	50	0.78	1770013
	16	50	0.81	1770014
	18	50	0.70	1770015
	20	50	0.66	1770016
	22	50	0.77	1770017
	28	50	0.66	1770018
2220/C		<i>Dekoratīvais dubultais šķīvītis (hromēts)</i>		
	15	50	3.73	1770019
	16	50	3.73	1770020
	18	50	3.73	1770021
	20	50	3.73	1770022
	22	50	3.73	1770023
	28	50	3.73	1770024













BLĪVES









		VEIKALS EUR		VEIKALS EUR					
	796	<i>Paranīta blīve</i>		<i>Gumijas blīves dozātoram</i>					
		3/8"(100)	3.78	0166022		215 V/796	Ø 12 mm	0.35	0566002
		1/2"(100)	4.59	0166003		216 V/796	Ø 28 mm	0.35	0566003
		3/4"(100)	7.95	0166004	<i>Gumijas blīve (čuguna veidgabaliem)</i>				
		1"(10)	1.32	0166008		03576	1/2"	0.32	2166001
		1,1/4"(10)	2.62	0166009			3/4"	0.28	2166002
	1,1/2"(10)	2.50	0166015			1"	0.46	2166003	
	2"(10)	3.66	0166016			1,1/4"	0.74	2166005	
						1,1/2"	0.66	2166004	
						2"	0.68	2166006	
	03572	<i>Gumijas blīve</i>							
		3/8"(100)	3.15	0466004		1/2" (10)	1.81	2166009	
		1/2"(100)	3.36	0466002		3/4" (10)	2.43	2166010	
		3/4"(100)	5.36	0466005		1" (10)	2.80	2166011	
		1"(10)	1.29	0466008		1,1/4" (10)	4.30	2166012	
		1,1/4"(10)	1.80	0466009		1,1/2" (10)	3.89	2166013	
		1,1/2"(10)	2.14	0466006		2" (10)	3.92	2166014	
	03574	<i>Gumijas blīve ar sietiņu</i>							
		3/8"	0.60	0466013		GUA 11	<i>Blīves PE savienojumiem</i>		
		1/2"	0.59	0466001		19x3,5	DN20	0.42	9066007
		3/4"	0.94	0466003		24x4	DN25	0.45	9066008
		3/8"(10)	3.50	0466012		31x4,5	DN32	0.65	9066009
	1/2" (10)	3.50	0466010	39x5,5		DN40	0.80	9066010	
	796/S	<i>Gumijas blīve iztekai</i>							
		Ø 16 mm(10)	6.90	0166018		<i>Blīve (konuss) bezvītņu savienojumiem</i>			
		Ø 18 mm(10)	3.28	0166005		03575	1/2"	1.24	0966001
	797	Pārslēdzējam(1)	0.25	0166031			3/4"	1.66	0966002
	Pārslēdzējam(10)	0.64	0166001			1"	1.85	0966003	
	796/G	<i>Plastmasas gredzens iztekai</i>							
		Ø 18 mm	0.26	0166020		1,1/4"	2.26	0966004	
	796/675	<i>Gumijas blīve dozātoriem</i>							
		Ø 18 mm (10)	2.62	0166028		1,1/2"	2.57	0966005	
		1/2"	0.59	0166007		2"	3.65	0966006	
	796/V	<i>Gumijas blīve krāna ventilim</i>							
		1/2"	1.20	0166013		1/2" (10)	7.10	0966019	
		3/8" (10)	6.88	0166029		3/4" (10)	9.41	0966020	
		1/2" (10)	7.07	0166030		1" (10)	10.30	0966021	
	R302-1078	Ø 35	5.42	0166019	<i>Blīves trīsdaļīgiem savienojumiem</i>				
	R302-0130	Ø 40	6.12	0166021		03570	1/2"	0.31	0966007
<i>Blīve virtuves jaucējkrānam</i>						3/4"	0.41	0966009	
	R 302-35 mm	Ø 35	2.94	0166023			1"	0.50	0966008
	R 302-40 mm	Ø 40	3.00	0166024			1,1/4"	0.59	0966011
	03573	<i>Gumijas blīve ekscentriem</i>							
		(10)	0.14	1166003			1,1/2"	0.66	0966010
			0.80	1166005			2"	0.73	0966012
	03571	<i>Gumijas blīve sifoniem (konuss)</i>							
		Ø 32 mm	0.37	7466001			1/2" (10)	1.77	0966013
		Ø 40 mm	0.43	7466002			3/4" (10)	2.32	0966014
		Ø 32 mm (10)	2.18	7466003		1" (10)	2.86	0966015	
	<i>Blīvju komplekts pedāļa dozātoram</i>				<i>Blīve WC skalojamai kastei</i>				
	401/796K		1.26	0566004		781			2.13
<i>Blīve pedāļa dozātoram</i>				<i>Blīve aeratoram ar ārējo vītņi</i>					
	401/796						03580	0.16	1166004
							03580/10	0.92	1166006
				<i>WC blīve skalojamai kastei podam</i>					
							U093	6.25	7866002

Blīvējumu materiāli

VEIKALS
EUR

VEIKALS
EUR

		<p>Blīvējamā pasta "UNIPAK"</p>	
65 gr	3.94	2566011	
250 gr	7.31	2566012	
			
		<p>Blīvējamā pasta "UNIPAK"</p>	
360 gr	8.10	2566013	
			
		<p>Teflona lente "UNITAPE"</p>	
12x12x0,075 mm	0.75	2566002	
			
		<p>Teflona lente "JUMBOTAPE"</p>	
10x19x0,2 mm	4.12	2566004	
			
		<p>Teflona lente "MAXITAPE"</p>	
12x12x0,1 mm	1.45	2566003	
			
		<p>Teflona lente "MIDITAPE"</p>	
12x12x0,1 mm	1.18	2566001	
			
		<p>Teflona lente</p>	
12x12x0,075 mm	0.27	4366001	

		<p>Teflona lente</p>	
19x15x0,25 mm	2.82	2566018	
		<p>Vītņu blīvējamais diegs, LOCTITE 55</p>	
50 m	8.40	2366001	
		<p>Vītņu blīvējamais diegs, LOCTITE 55</p>	
160 m	17.31	2366002	
		<p>Auduma, mitrumizturīga limlenta, pelēka</p>	
48mmx50m	8.06	2566019	
		<p>HT smērviena</p>	
150 gr	3.23	6866003	
250 gr	3.76	6866004	
1000 gr	10.25	6866005	
		<p>Vītņu blīvējamais diegs, MAGMA</p>	
20 m	4.03	7166005	
50 m	5.55	7166003	
150 m	11.66	7166004	
			
			

VEIKALS
EURVEIKALS
EUR

 <p><i>Blīvējamā pasta "GEBATOUT 2"</i></p> <p>80 gr PASTA-GEB 3.34 6766001 200 gr PASTA-GEB 4.94 6766002</p> <p><i>Izmanto ūdens, gāzes un saspiesta gaisa sistemās. Savienojuma spiediena izturība līdz 200Bar, max t° līdz 130°</i></p>	 <p><i>Lini mīkstā spole</i></p> <p>100 g 3.89 2566009 515031 80 gr Francija 3.91 6766036</p>
 <p><i>Blīvējamā pasta "GEBATOUT 2"</i></p> <p>500 gr PASTA-GEB 6.65 6766003</p>	 <p><i>Lini 80 gr (plastmasas traukā)</i></p> <p>515030 80 gr Francija 7.97 6766022</p>
 <p><i>Instalācijas komplekts</i></p> <p>Blisteris 80g+20g 5.95 6766031</p>	 <p><i>Hermetizējoša aukla no 100% teflona</i></p> <p>80 m 815500 10.47 6766007</p> <p><i>Iztur hidrotriecienu un vibrāciju. T° izturība no -190° līdz +260°; spiediens līdz 15Bar. Pietiek 65gab 1/2 savienojumiem.</i></p>
 <p><i>Blīvējamā mastika FILGUM</i></p> <p>200 gr 104019 4.62 6766045</p> <p><i>Elastīga mastika spraugu blīvēšanai. Savienojuma vietu, šuvju un plaisu hermetizācijai un aizpildīšanai. Santehnikas iekārtu (notekas, sifoni, izlietnes, vannas, tualetes u.c.) uzstādīšanas laikā radušos spraugu blīvēšanai.</i></p>	 <p><i>Hermetizējoša blīvējamā aukla</i></p> <p>100 m 515100 26.94 6766006</p> <p><i>Pie ietojams metāla un plastmasas savienojumiem. Iztur hidrotriecienu un vibrāciju. Aukstā ūdens spiediena izturība max 16Bar. Pie 130°C max 7Bar.</i></p>
 <p><i>Silikona hermētiķis "GEBSICONE W"</i></p> <p>"W" balts 310 ml 893400 7.40 6766004 "W" C.S. 310 ml 893403 7.40 6766005</p>	 <p><i>Hermetizējoša blīvējamā aukla</i></p> <p>25 m 515200 6.39 6766041</p>
 <p><i>Kusnis lodēšanai ar alvu "HAMPTON"</i></p> <p><i>Kusnis lodēšanai ar alvu. Satur cinka hlorīdu. Paredzēts dzelzs, tērauda, čuguna, vara, bronzas, misiņa, cinka u.c. metālu lodēšanai izņemot alumīniju! Aktivizējas pie +75°C līdz +375°C.</i></p> <p>175 gr 100111 11.48 6735002</p>	 <p><i>Teflona lente "RUBAN"</i></p> <p>12mm*12m*0,075mm 0.60 6766009 ķīmiskām</p>
 <p><i>Alva lodēšanai SN9 Sn97Cu3</i></p> <p>100 gr 815708 20.88 6735004</p>	 <p><i>Zila Fum lente</i></p> <p>12mm*12m*0,1mm 0.86 6766010</p> <p><i>Nejūtīga pret ķīmiskām piedevām un mikro organismiem. Spiediena izturība max 15Bar (silts/auksts), temperatūras izturība no -260° līdz +260°</i></p>
 <p><i>Līme vara un misiņa savienojumiem "RLC+"</i></p> <p>30 ml 814655 17.53 6766046</p>	 <p><i>Fum lente degvielai un eļļām</i></p> <p>12mm*12m*0,1mm 1.26 6766032</p> <p><i>Nejūtīga pret ķīmiskām piedevām un mikro organismiem. Izmantojama arī degvielai un eļļām. Degvielai, Spiediena izturība max 15Bar (silts/auksts), temperatūras izturība no -260° līdz +260°. Blīvums 0.8mm</i></p>
 <p><i>Lini fice</i></p> <p>100 g Francija 1.71 6766023 200 g 3.75 2566007 500 g 9.03 2566008</p>	 <p><i>Zaļa Fum lente</i></p> <p>19mm*15m*0,2mm 3.96 6766011</p>
	 <p><i>Fum lente gāzei</i></p> <p>12mm*12m*0,1mm 3.40 6766012</p> <p><i>Izcila ķīmiskā inerce: butāna, propāna, dabasgāzes, saspiesta gaisa, slāpekļa, ūdeņraža, hēlija, argona, uc gāzēm. Temperatūras izturība -260° līdz +260° C</i></p>

**VEIKALS
EUR**

**VEIKALS
EUR**

GEB-KIT



4/5/6*2,5 m **15.90 6772002**
7/8*2,5 m **16.12 6772003**
10*2,5 m **18.62 6772004**

Hermetizācijas komplekts krāšņu piedurļiņiem.
1. Apaļa termo aukla (Ø 5x2,5 m)+Collafeu (20ml)
2. Apaļa termo aukla (Ø 8x2,5 m)+Collafeu (20ml)
3. Plakana termo aukla (10mmx2.5mmx2.5m)+Collafeu (20ml)
(Collafeu – termoizturīga līme šķiedrainai izolācijas materiālu pielīmēšanai pie virsmām, kuras pakļautas augstām temperatūrām, līdz +1100°C)

GEB-COLLAFEU



50 ml **5.40 6772006**

Termoizturīga līme šķiedrainu izolācijas materiālu pielīmēšanai pie virsmām, kuras pakļautas augstām temperatūrām (līdz +1100°C)

GEB-CALORYGEB



300 gr. **5.65 6772008**
310 ml **8.09 6772007**

Ugunsizturīga mastika, kuru viegli pielietot montējot krāsnis, kamīnus, kā arī veicot remontdarbus un novēršot defektus to virspusē. Izmantojams kā hermētiķis plaisām un salaiduma vietās ar kurtuvi, dūmvadu u.c. Temperatūras izturība līdz +1100°C. Uzklāt uz tīras, samitrinātas virsmas. Lietot 90% CALORYGEB un 10% ūdens. Ļaut nožūt 48 stundas.

GEB-PROPFEU POWDRE



900 gr. **12.46 6772011**

Kīmiskai dūmvadu apstrādei. Efektīvi noņem darvu, sveķus un nosēdumus, kurus nevar noņemt mehāniski. Uzbērt uz kvēlojošām oglēm ieteicamo mērtrauciņu skaitu. Katalītiska reakcija pārvērtīs darvu un sveķus par nedegošiem. Daļa nokritīs kurtuvē, daļa tiks iznesta ar vilkmi. Ja nepieciešams pēc tam tiek veikta mehāniskā dūmvada tīrīšana. Nelietot šķidrā kurināmā un gāzes katlos.

GEB-PROPFEU



500 ml **11.30 6772009**

Līdzeklis kamīnu/ krāšņu stiklu tīrīšanai. Ātri šķīdina darvas un kvēpu nosēdumus. Nelietot alumīnija virsmām. Instrukcija: Aizsargājiet (apsedziet) apkārtējās virsmas ar lupatu. Izsmidzina uz aukstas vai siltas virsmas. Ļauj iedarboties 1 minūti. Notīra

GEB-DEBOUCHEUR UNIVERSEL

1 L **8.82 6772013**



Šķidr līdzeklis aizsērējumu attīrīšanai dušas kabīnēs, izlietnēs un kanalizācijā. Var izmantot emaljētām virsmām, fajansam, nerūsējošam tēraudam, hromētām virsmām, čuguna un plastmasas cauruļvadiem. Ieliet 0.5 l šķīduma sifonā (1 l podiem) un atstāt no 30 min., līdz 12 h, atkarībā no aizsērējuma. Skatīt ar lielu daudzumu ūdens. Nekādā gadījumā šo līdzekli nejaukt ar citiem līdzekļiem!!!

GEB-DEBOUCHEUR PROFESIONEL

1 L **9.54 6772012**



Ļoti iedarbīgs (spēcīgs) šķidr līdzeklis izšķīdina kaļķa nogulsnes, organiskus u.c. savienojumus. Liet līdzekli kanalizācijā (izmantojot piltuvi). Skatīt ar lielu daudzumu ūdens. Tualetes (izņemot ķīmiskās) ½ -1 iep., izlietnes ¼ - ½ iep., kanalizācija ¼ -1/2 iep. Līdzeklis nav lietojams emaljētām un hromētām virsmām. Nekādā gadījumā šo līdzekli nejaukt ar citiem līdzekļiem!!! Izdala siltumu.

VEIKALS
EUR

VEIKALS
EUR

GEB-DEBOUCHEUR KIT

Ø25-Ø50 **28.59** 6735006



Mehāniskās cauruļu tīrīšanas komplekts „Kit Deboucheur”
Lietošanas instrukcija: Izmantojiet cimdus un aizsargbrilles. Pirms lietošanas nepieciešams: 1) Izjaukt sifonu, ja sifona caurule nav pieejama. 2) Nobloķēt pārplūdi, kā arī blakus izlietni, ja tāda ir uzstādīta. 3) Ja ir uzstādīta vēl kāda caurule pirms aizsprosta, arī tās izeja ir jānobloķē. 4) Ja nav iespējams pilnībā ievietot mehānisko cauruļu tīrītāju (atbloķētāju) caurulē, izmantojiet komplektā esošo caurulīti un lieciet to pie noteces. Pilnībā ievietojiet atbloķētāju caurulē un atveriet ūdeni lēnā plūsmas režīmā, ūdens temperatūrai jābūt zemākai par 30°C, Kad atbloķētājs būs piepildījies ar ūdeni, tas nosprostos cauruli. Starp atbloķētāju un aizsprostu piepildīsies ūdens kas izspiedīs vai izjauks aizsprostu. Nelietot ar karsto ūdeni. Nelietot WC podā. Nelietot gofrās un lokanās caurulēs. Nelietot, ja pirms tam izmantots ķīmiskais cauruļu tīrīšanas līdzeklis

GEB-SPRAY

500 ml **9.50** 6766028



Aerosols uz 100% silikona eļļas bāzes, nelīpoša un ūdensizturīga, paredzēta: Eļļošanai, aizsardzībai pret mitrumu, lipšanas novēršanas līdzeklis gumijai, novērš blīvju nodilšanu un deformācijas. Palīg līdzeklis izņemšanai no formas, novērš vaska vai saistvielu lipšanu, ideāli piemērots puteklainai videi, lietošanai ar tvertni gan uz augšu, gan uz leju.

GEB-PLAQUE

1m2 **38.32** 6766017



Termoizolējošs minerālu pārklājs. Pielieto krāsns virsmu, dūmvadu, kurtuvju apdarei un sienu izolācijai no karstuma iekārtām. Līdz +1100°C. Paklāja fiksācijai pielieto līmi - COLLAFEU

GEB-GEBEX

200 gr **3.62** 6766015
500 gr **5.17** 6766016



Montāžas smēre cauruļvadiem kura nesatur silikonu. Pielieto plastikas cauruļvadu montāžā, uzmašanās un gumijas blīvju uzstādīšanā u.c. *Piemērots spiediena un kanalizācijas caurulēm. *Nodrošina vieglu slīdēšanu. *Aizsargā gumijas blīvējumus.

Daudzfunkcionālā līme-mastika "GEB-MS"

280 ml 892001 **10.52** 6766042



Vienkomponenta blīvēšanas un līmēšanas mastika, kura izgatavota no MS Polymer. Sacietē saskarē ar apkārtējās vides mitrumu: Pielietojums: Ūdensizturīgu šuvju aizpildīšana būvniecībā (betons, koks, stikls, metāls, PVC u.c.). Izplešanās šuvju aizpildīšana. Hidroizolācijas šuves starp mūri un koku. Zem koka, metāla vai PVC apdares materiālu apakšējās daļas. Plaisu aizpildīšana. Līmēšana iekšējās un ārpus tām (apšuvuma briketes, līstes, cokoli, polistirola elementi, spoguļi, ventilācijas atveres, elektrības kastes, akustiskā izolācija utt.).

GEB-GEBEX PLUS

400 gr **5.11** 6766025



Uz silikona bāzes veidota formula visu veidu cauruļvadu eļļošanai: plastmasas, čuguna, betona, u.c., kā arī gumijas blīvju aizsardzībai jebkuros laika apstākļos.

GEB-GEBEX TAP

20 ml **4.44** 6766040



Savienotājelementu eļļošanai. Novērš ūdeni esošā kaļķakmens nosēdumu veidošanos uz eļļotajām virsmām.

Mastika baseiniem

balta 290 ml 590910 **15.99** 6766043
caurspīdīga 290 ml 590911 **15.99** 6766044



Neitrāla vienkomponenta polimēru mastika uz modificēta silikona bāzes. Paredzēts noplūžu līmēšanai, savienošanai un blīvēšanai iekšējās, ārējās un zem ūdens.

Paredzēts īpaši peldbaseiniem, spa un balneoterapijas zonām. Piemērots gadījumiem, kad nepieciešama materiāla paaugstināta stabilitāte zem ūdens. Tam ir augsta sākotnējā saķere, tāpēc bieži vien nav nepieciešama balstu un pastiprinājumu uzstādīšana. Hidroizolācija (ūdens attīrīšanas ierīces, prožektoru, caurules, apmalītes, siltumnīcas, segumi utt.)

GEB-GEBETANCHE+

75ml **21.73** 6766013















Universālie anarobie sveķi paredzēti metāla vītņu savienojumiem jebkuriem izplatītajiem nesējiem. Jaunā tehnoloģija paredzēta ātrai, tīrai un ekonomiskai metāla vītņu montāžai. Lietojams bez līmiem. Viena tūbiņa paredzēta 100 savienojumiem ar izm. 1"







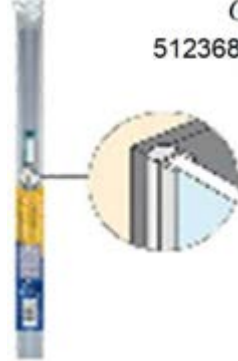





Paredzēta aukstā un karstā ūdens sistēmās, apkures sistēmās, gāzes apgādes sistēmās, ogļskābās gāzes padeves sistēmās, apkures sistēmās (butāns, propāns, dīzeldegviela, mazulsts u.c.)











* Ieteicams lietot dzeramajam ūdenim (klasifikācijas WRAS, standarts BS 6920).
* Temperatūras izturība: no -30°C līdz +130°C, +150°C pie īslaicīgas uzkaršanas.
* Spiedienu izturība >170 bar.







VEIKALS
EUR













VEIKALS
EUR











	<p><i>Remontlenta caurulēm</i> 1,5*0,05m 16.97 6766024</p> <p>Paredzēts dažādu plaisu, caurumu un citu bojājumu ātram remontam. Lietojams tikai uz cietām, nelokāmām virsmām. Plaši pielietojams apkures, kanalizācijas un citu sistēmu remontam. Derīgs uz mitrām virsmāk, kā arī iegremdētām ūdenī (max 1m). Žūšanas laiks 30min. Spiediena izt. max 20 Bar; Temp. max izturība 125°C</p>	 <p><i>Dezinfekcijas līdzeklis kondicionieriem G95</i> 850410 1l 13.19 6772029 5l</p>
	<p>GEB PRETaPOSER Stūra montāžas lente</p> <p>40mm*3,35m 19.52 6766021</p>	 <p><i>Aizsarglīdzeklis pret koroziju, kaļķakmeni apkures sistēmā G11</i> 871130 1l 37.27 6772022</p>
	<p><i>Vannas istabas tīrīšanas līdzeklis</i> 500 ml 4.44 8272003</p> <p>Paredzēts porcelāna un keramikas flīžu, izlietņu, jaucējkrānu, dušas galviņu, tualetšu utt. regulārai tīrīšanai. Viegli noņem visgrūtākās kaļķa nogulsnes un nodrošina virsmu ar dabisku spīdumu. Efektīvi notīra netīrumus, ziepju un ūdens nogulsnes. Lietošanas instrukcija: pagrieziet dozatoru uz SPRAY pozīciju. Izsmidzināt tieši uz virsmas no 15-20 cm attālumaļaujiet līdzeklim 2-3 minūtes iedarboties. Nosalucīt ar mitru drānu vai noskalot ar ūdeni. Uzglabāt oriģinālajā iepakojumā! Sargāt no bērniem! Glabāšanas temperatūra 5°C - 25°C</p>	<p><i>Nogulšņu noņemšanai esošās apkures sistēmās G30</i></p>  <p>1l 18.48 6772030</p>
	<p><i>Pasta vītņu blīvēšanai saules paneļos</i> 250 gr. 9.05 6766039</p>	<p><i>Degļu un filtru tīrīšanas līdzeklis G80</i> 500 ml 14.58 6772031</p> 
	<p>105579 <i>Līdzeklis sūces novēršanai G40</i> 2l 33.66 6772024</p>	<p>512369 <i>Apakšējā durvju gumija 5-8 mm biezam stiklam</i> 1 m 10.27 6774001</p> 
		<p>512368 <i>Gumija dušas kabīnes stiklam, vertikāli 5-8 mm biezam stiklam</i> 2 m 17.36 6774000</p> 
		<p>873016 <i>Lokanais pievads radiatoru uzpildei</i> 12.95 6735007</p> 













		GAB.	EUR	VEIKALS
	1000G	<i>Stucēris ar ārējo vītņi</i>		
	1/4"x10	25	0.94	0925342
	3/8"x10	25	1.28	0925343
	3/8"x13	25	1.28	0925344
	1/2"x10	25	1.61	0925092
	1/2"x13	25	1.61	0925093
	1/2"x15	25	1.61	0925100
	1/2"x18	10	1.67	0925345
	1/2"x20	10	1.61	0925269
	3/4"x20	10	2.70	0925101
	3/4"x25	10	2.82	0925270
	1"x20	10	3.67	0925292
	1"x25	10	3.88	0925094
	1,1/4"x32	5	6.72	0925242
1,1/2"x40	5	11.87	0925243	
2"x50	5	16.13	0925244	
	1001G	<i>Stucēris ar iekšējo vītņi</i>		
	1/4"x10	25	0.97	0925346
	3/8"x10	25	1.47	0925347
	1/2"x10	25	1.84	0925095
	1/2"x13	25	1.86	0925096
	1/2"x15	25	1.88	0925097
	1/2"x18	10	2.08	0925348
	1/2"x20	10	1.88	0925271
	3/4"x20	10	2.84	0925098
	3/4"x25	10	2.96	0925272
	1"x25	10	4.31	0925099
	1,1/4"x32	5	9.79	0925245
	1,1/2"x40	5	13.46	0925246
	2"x50	5	24.19	0925247
	1002G	<i>Stucēris divpusējs (eģlīte)</i>		
	1/2"	25	2.03	0925297
	3/4"	25	2.68	0925298
	1"	10	3.98	0925299
	670	<i>Stucēris ar iekšējo vītņi (hromēts)</i>		
	3/4"x15		1.26	0921127
	1700G	<i>Piecgabals (90mm)</i>		
	1"x20		3.67	0921128
	1790G	<i>Kontruzgrieznis ar apmali</i>		
	1/2"	25	1.67	0925108
	3/4"	25	1.72	0925109
	1"	10	2.60	0925262
	1,1/4"	10	3.47	0925294
	1,1/2"	10	4.60	0925340
	1791G	<i>Kontruzgrieznis</i>		
	1/2"	50	0.98	0925190
	3/4"	50	1.11	0925191
	3660C	<i>Trīsdalīgs līkums radiatoriem (hromēts)</i>		
	1/2"	10	6.01	0921044
	3/4"	10	8.32	0921045
	1"		13.23	0921046
	3660G	<i>Trīsdalīgs līkums radiatoriem</i>		
	1/2"	10	5.44	0925326
	3/4"	10	10.31	0925327
	1"		13.10	0925328
	1,1/4"		21.76	0925329
	3661C	<i>Taisns trīsdalīgs savienojums (hromēts)</i>		
	1/2"	10	4.47	0921047
	3/4"	10	5.98	0921048
	1"		10.12	0921049
	3661G	<i>Taisns trīsdalīgs savienojums</i>		
	1/2"	10	4.14	0925330
	3/4"	10	6.55	0925331
	1"		11.43	0925332
	1,1/4"		20.19	0925333
	1,1/2"		24.26	0925258
	5003G	<i>Pāreja- saskrīve</i>		
	1"x1,1/2"	2	7.05	0925152
	7403G	<i>Taisns trīsdalīgs savienojums</i>		
	1/2"x1/2"	10	5.14	0925260
	3/4"x3/4"	10	7.40	0925263
	1"x1"		11.25	0925261

		GAB.	EUR	VEIKALS
	4025	<i>Saskrīve ar pretvārstu</i>		
	3/4"		11.05	0925315
	7500G	<i>Trīsdalīgs savienojums ar gumijas blīvi</i>		
	1/2"	10	8.14	0925159
	3/4"	5	12.50	0925160
	1"	5	14.00	0925161
	1,1/4"	5	26.05	0925310
	1,1/2"		36.47	0925311
	5006G	<i>Ūdens skaitītāja pieslēguzgrieznis</i>		
	1/2"x3/4"	10	3.14	0925225
	3/4"x1"	5	6.31	0925162
	1"X1,1/4"	5	10.98	0925164
	5200C	<i>Pāreja ar ārējām vītņēm (hromēta)</i>		
	3/8"x1/2"	25	1.61	0921001
	5200G	<i>Pāreja ar ārējām vītņēm</i>		
	1/8"X1/4"	25	0.89	0925248
	1/4"x3/8"	25	0.98	0925226
	1/4"x1/2"	25	1.26	0925104
	3/8"x1/2"	25	1.26	0925001
	1/2"x3/4"	10	1.79	0925002
	1/2"x1"	10	2.88	0925003
	3/4"x1"	10	2.93	0925004
	3/4"x1,1/4"	10	4.38	0925005
	1"x1,1/4"	10	4.51	0925006
	1"x1,1/2"	10	6.89	0925007
	1"x2"	5	11.18	0925188
	1,1/4"x1,1/2"	5	7.26	0925008
	1,1/4"x2"	5	11.91	0925120
1,1/2"x2"	5	11.39	0925009	
	5300C	<i>Pāreja ar ārējām vītņēm (hromēta)</i>		
	1/8"	25	0.59	0921124
	3/8"	25	1.14	0921120
	1/2"	25	1.28	0921003
	3/4"	10	1.95	0921004
	5300G	<i>Pāreja ar ārējām vītņēm</i>		
	1/8"	25	0.54	0925293
	1/4"	25	0.78	0925112
	3/8"	25	0.96	0925010
	1/2"	25	1.13	0925011
	3/4"	10	1.46	0925102
	1"	10	2.55	0925012
1,1/4"	10	4.65	0925013	
	5500C	<i>Vītņu pāreja (I-Ā) (hromēta)</i>		
	3/8"x1/2"		0.81	0921077
	1/2"x3/4"		1.06	0921053
		5600C	<i>Vītņu pāreja (I-Ā) (hromēta)</i>	
3/8"x1/2"		25	1.16	0921006
1/2"x3/4"		25	1.53	0921007
1"x1,1/4"		10	5.43	0921119
	5600G	<i>Vītņu pāreja (I-Ā)</i>		
	1/8"X1/4"	25	0.75	0925103
	1/8"X3/8"	25	0.93	0925194
	1/4"x3/8"	25	0.96	0925227
	1/4"x1/2"	25	1.21	0925105
	3/8"x1/2"	25	0.97	0925016
	1/2"x3/4"	25	1.07	0925017
	1/2"x1"	10	2.51	0925018
	1/2"X1,1/4"	10	5.28	0925020
	3/4"X1"	10	2.07	0925019
	3/4"x1,1/4"	10	4.29	0925021
	3/4"x1,1/2"	10	6.43	0925023
	1"x1,1/4"	10	3.60	0925022
	1"x1,1/2"	10	5.73	0925024
	1"x2"	5	10.87	0925026
	1,1/4"x1,1/2"	5	4.58	0925025
1,1/4"x2"		8.66	0925027	
1,1/2"x2"		8.56	0925028	

	GAB.	EUR	VEIKALS	
	<i>Korkis ar iekšējo vītņi (hromēts)</i>			
	1/2"	25	1.09 0921008	
	3/4"	25	1.61 0921009	
	<i>Korkis ar iekšējo vītņi</i>			
	1/4"	25	0.79 0925113	
	3/8"	25	0.72 0925029	
	1/2"	25	0.91 0925030	
	3/4"	25	1.10 0925031	
	1"	10	1.77 0925032	
	1,1/4"	10	3.09 0925033	
	1,1/2"	10	4.13 0925034	
	<i>Korkis ar ārējo vītņi (hromēts)</i>			
	1/2"	25	1.03 0921010	
	3/4"	25	1.61 0921011	
	<i>Korkis ar ārējo vītņi</i>			
	1/4"	25	0.66 0925114	
	3/8"	25	0.82 0925115	
	1/2"	25	1.07 0925035	
	3/4"	25	1.61 0925036	
	1"	10	2.70 0925037	
	1,1/4"	10	4.18 0925038	
	1,1/2"	10	5.98 0925039	
	<i>Pagarinātājs (hromēts)</i>			
	1/2"x10	25	1.60 0921012	
	1/2"x15	25	2.10 0921051	
	1/2"x20	10	2.37 0921013	
	1/2"x25	10	2.81 0921122	
	1/2"x30	10	3.08 0921014	
	1/2"x40	10	3.72 0921015	
	1/2"x50	10	4.60 0921016	
	1/2"x65	10	5.49 0921017	
	1/2"x80	10	11.03 0921125	
	1/2"x100	10	14.07 0921126	
	3/4"x10	25	2.23 0921115	
	3/4"x20	25	2.95 0921116	
	3/4"x30	10	3.94 0921018	
	3/4"x40	10	5.00 0921117	
	3/4"x50	10	5.72 0921019	
	1"x10	10	3.51 0921078	
	1"x15	10	3.98 0921079	
	1"x20	10	4.60 0921080	
	1"x25	10	5.28 0921081	
	1"x30	10	6.00 0921082	
	1"x40	5	7.42 0921083	
	1"x50	5	8.98 0921084	
		<i>Pagarinātājs</i>		
		1/2"x10	25	1.40 0925041
1/2"x15		25	1.74 0925042	
1/2"x20		10	2.03 0925043	
1/2"x25		10	2.23 0925233	
1/2"x30		10	2.58 0925044	
1/2"x40		10	3.26 0925045	
1/2"x50		10	4.10 0925046	
1/2"x65		10	4.70 0925047	
1/2"x80		10	7.77 0925234	
1/2"x100		10	9.47 0925235	
3/4"x10		10	2.03 0925048	
3/4"x15		10	3.04 0925304	
3/4"x20		10	2.84 0925049	
3/4"x30		10	3.63 0925050	
3/4"x40		10	4.44 0925051	
3/4"x50		10	4.93 0925052	
3/4"x60		10	9.99 0925305	
3/4"x80		10	12.68 0925306	
1"x20		10	4.23 0925229	
1"x25		10	5.21 0925163	
1"x30		10	5.42 0925230	
1"x40		5	6.26 0925231	
1"x50		5	7.58 0925232	
		<i>Pagarinātājs</i>		
	1/2"x10	10	1.11 0925154	
	1/2"x15	10	1.27 0925155	
	1/2"x20	10	1.60 0925156	
	1/2"x30	10	2.21 0925157	
	1/2"x40	10	2.54 0925158	













	GAB.	EUR	VEIKALS
	<i>Vītņu pāreja (A-I) (hromēta)</i>		
	3/8"x1/2"	25	1.75 0921020
	1/2"x3/4"	10	2.26 0921021
	1/2"x1"	10	2.82 0921022
	3/4"x1"	10	3.24 0921023
	<i>Vītņu pāreja (A-I)</i>		
	3/4"x1,1/4"	10	4.22 0921054
	1/4"x3/8"	25	1.32 0925236
	1/4"x1/2"	25	1.28 0925237
	3/8"x1/2"	25	1.67 0925193
	<i>Uzmava (hromēta)</i>		
	1/2"x3/4"	10	1.91 0925054
	1/2"x1"	10	2.47 0925055
	3/4"x1"	10	2.75 0925056
	3/4"x1,1/4"	10	3.84 0925110
	1"x1,1/4"	10	3.72 0925111
	1,1/4"x1,1/2"	5	8.42 0925166
	1,1/2"x2"	5	11.29 0925167
	<i>Uzmava</i>		
	3/8"	25	1.58 0921121
	1/2"	10	1.98 0921024
	3/4"	10	2.73 0921025
	1"	10	4.24 0921026
	1/4"		0.96 0925238
	3/8"		1.26 0925057
	<i>Uzmava ar pāreju (I-I) (hromēta)</i>		
	1/2"	10	1.68 0925058
	3/4"	10	2.23 0925059
	1"	10	3.88 0925060
	1,1/4"		4.84 0925061
	1,1/2"		7.88 0925062
	2"		12.99 0925063
	<i>Uzmava ar pāreju (I-I)</i>		
	3/8"x1/2"	25	1.81 0921027
	1/2"x3/4"	10	2.72 0921028
	1/2"x1"	10	3.77 0921029
	3/4"x1"	10	4.60 0921030
	3/4"x1,1/4"		7.85 0921031
	1"x1,1/4"		6.91 0921032
	3/8"x1/2"		1.56 0925064
	<i>Līkums (I-A) (hromēts)</i>		
	1/2"x3/4"	10	2.23 0925065
	1/2"x1"	10	3.05 0925066
	3/4"x1"	10	3.72 0925069
	3/4"x1,1/4"	10	7.44 0925067
	1"x1,1/4"		6.38 0925068
	1,1/4"x1,1/2"		10.38 0925106
	1,1/2"x2"		18.99 0925107
	<i>Līkums (I-A)</i>		
	3/8"	25	3.09 0921033
	1/2"	10	3.31 0921034
	3/4"	10	4.93 0921050
	1"		7.30 0921035
	1,1/4"		16.37 0921052
	<i>Līkums ar pāreju (I-A)</i>		
	1,1/2"		20.16 0921118
	1/4"	25	2.19 0925239
	3/8"	25	2.33 0925070
	1/2"	10	2.46 0925071
	3/4"	10	4.14 0925074
	<i>Līkums (I-I) (hromēts)</i>		
	1"		6.02 0925072
	1,1/4"		11.42 0925073
	<i>Līkums ar pāreju (I-A)</i>		
	1,1/2"		14.63 0925119
	2"		27.38 0925189
	1/2"x3/4"	10	4.10 0925265
	<i>Līkums (I-I) (hromēts)</i>		
	3/4"x1"	10	6.09 0925266
	3/8"		2.88 0921036
	1/2"	10	3.55 0921037
	<i>Līkums (I-I) (hromēts)</i>		
	3/4"	10	4.40 0921038
	1"		7.65 0921039









		GAB.	EUR	VEIKALS
	6400G	<i>Likums (I-I)</i>		
	1/4"	25	2.15	0925240
	3/8"	10	2.27	0925075
	1/2"	10	2.67	0925076
	3/4"	10	3.67	0925077
	1"		6.44	0925078
	1,1/4"		10.24	0925079
	1,1/2"		14.80	0925080
2"		26.55	0925081	
	6402G	<i>Likums (A-A)</i>		
	1/2"	10	3.41	0925274
	3/4"	10	4.86	0925275
1"	10	8.14	0925276	
	3402G	<i>Likums (A-A)</i>		
	1/2"	10	3.65	0925316
	3/4"	10	6.25	0925317
1"	10	9.68	0925318	
	6403G	<i>Likums ar pāreju(I-I)</i>		
	1/2"x3/4"	10	4.31	0925195
	1/2"x1"	10	9.01	0925196
3/4"x1"	10	7.95	0925197	
	6306G	<i>Likums ar sienas stiprinājumu (I-A)</i>		
1/2"	10	5.44	0925264	
	6406G	<i>Likums ar sienas stiprinājumu (I-I)</i>		
1/2"	10	4.02	0925277	
	6500C	<i>Treigabals (I-I-I)(hromēts)</i>		
	3/8"	10	3.39	0921040
	1/2"	10	3.42	0921041
	3/4"	10	5.23	0921042
1"		8.35	0921043	
	6500G	<i>Treigabals (I-I-I)</i>		
	1/4"	25	2.64	0925241
	3/8"	10	2.76	0925082
	1/2"	10	2.79	0925083
	3/4"	10	3.90	0925084
	1"		7.14	0925085
	1,1/4"		12.17	0925086
	1,1/2"		17.98	0925087
2"		23.46	0925088	
	6502G	<i>Treigabals (A-A-A)</i>		
	1/2"	10	4.63	0925267
	3/4"	10	4.26	0925268
1"	10	8.26	0925291	
	6510G	<i>Treigabals (I-I-A)</i>		
	1/2"	10	3.00	0925278
	3/4"	10	4.58	0925279
1"	10	9.72	0925319	
	6511G	<i>Treigabals (A-I-A)</i>		
	1/2"	10	3.14	0925280
3/4"	10	5.28	0925281	

		GAB.	EUR	VEIKALS
	6512G	<i>Treigabals (I-A-A)</i>		
	1/2"	10	3.15	0925282
3/4"	10	5.28	0925283	
	6513G	<i>Treigabals (I-A-I)</i>		
	1/2"	10	3.07	0925273
3/4"	10	4.58	0925284	
	6503G	<i>Treigabals ar pāreju (I-I-I)</i>		
	3/4"x1/2"x3/4"	10	4.88	0925089
	1"x1/2"x1"	5	8.30	0925090
1"x3/4"x1"	5	8.26	0925091	
	6506G	<i>Krusts</i>		
	1/2"	10	5.10	0925118
	3/4"	5	7.77	0925116
1"		11.96	0925117	
	1750G	<i>Tvertnes starpsienu savienojums</i>		
	1/2"		6.72	0925285
3/4"		8.65	0925286	
	1760G	<i>Tvertnes starpsienu savienojums</i>		
	1/2"		6.09	0925287
3/4"		7.38	0925288	
	1770G	<i>Tvertnes starpsienu savienojums</i>		
	1/2"	10	4.51	0925289
3/4"	10	5.15	0925290	
	644	<i>Uzmavas atzare</i>		
	1/2"		10.00	0925320
3/4"		13.40	0925321	
	1308	<i>Uzmavas atzare</i>		
	1/2"x1/2"	16	7.96	0925322
	1/2"x3/4"	12	9.66	0925323
	1/2"x1"		13.86	0925324
3/4"x1"		15.54	0925325	
	7600	<i>Ekscentrs (hromēts)</i>		
	1/2"x10	10	5.86	0921071
	1/2"x20	10	8.84	0921072
	1/2"x30	10	9.26	0921073
	1/2"x40	10	9.52	0921074
	1/2"x50	10	10.07	0921075
1/2"x60	10	11.31	0921076	
	6700C	<i>Likums WC pieslēgšanai (hromēts)</i>		
1/2"x1/2"		5.51	0921085	
	6800C	<i>Likums WC pieslēgšanai (hromēts)</i>		
1/2"x10		6.29	0921086	
	6801C	<i>Likums WC pieslēgšanai (hromēts)</i>		
1/2"x10		6.29	0921087	

GAB. EUR VEIKALS





GAB. EUR VEIKALS









	6804 C	<i>Līkums (IV) ar pāreju uz cauruli</i>		
	1/2"x10	10	3.94	0921093
	1/2"x12	10	3.94	0921094
	6900C	<i>Pāreja ārējā vītne uz cauruli (hromēta)</i>		
	1/2"x10	25	2.35	0921065
	1/2"x12	25	2.34	0921066
	6901C	<i>Uzmava (hromēta)</i>		
	10x10	25	3.02	0921067
	12x12	25	3.16	0921070
	6902C	<i>Pāreja iekšējā vītne uz cauruli (hromēta)</i>		
	1/2"x10	25	2.75	0921068
	1/2"x12	25	2.95	0921069
	6904C	<i>Līkums 90° (hromēts)</i>		
	10x10	10	4.55	0921061
	12x12	10	4.86	0921113
	6905C	<i>Trejšgabals (hromēts)</i>		
	10x10x10	10	6.00	0921062
	12x12x12	10	7.15	0921114
	1176	<i>Kompresijas savienojums</i>		
	3/8"x10		1.85	0921129
	6906C	<i>Caurule rullī 5m (hromēta)</i>		
	ø10		49.91	0921063
	ø12		62.11	0921064
	18	<i>Caurule taisnā (hromēta)</i>		
	ø10x100		11.11	0921130
	3010G	<i>Pāreja ar ārējo vītni</i>		
	1/2"x20	75	3.98	0918001
	3/4"x25	50	4.95	0918002
	1"x32	20	7.75	0918003
	1,1/4"x40	14	11.60	0918004
	1,1/2"x50	9	17.42	0918005
	2"x63	12	34.63	0918006
	3011G	<i>Pāreja ar iekšējo vītni</i>		
	1/2"x20	75	4.05	0918007
	3/4"x25	50	5.37	0918008
	1"x32	20	8.30	0918009
	1,1/4"x40	14	12.03	0918010
	1,1/2"x50	9	17.52	0918011
	2"x63	12	35.32	0918012
	3012G	<i>Uzmava</i>		
	20x20	40	6.81	0918013
	25x25	30	9.05	0918014
	32x32	18	13.43	0918015
	40x40	7	19.08	0918016
	50x50	4	29.45	0918017
	63x63		60.19	0918018

	3013G	<i>Līkums</i>		
	20x20	35	7.73	0918019
	25x25	20	10.02	0918020
	32x32	12	15.38	0918021
	40x40	6	23.48	0918022
	50x50	8	36.52	0918023
	63x63		68.42	0918024
	3014G	<i>Līkums ar iekšējo vītni</i>		
	1/2"x20	50	4.88	0918025
	3/4"x25	35	6.72	0918026
	1"x32	18	10.73	0918027
	1,1/4"x40	10	16.97	0918028
	1,1/2"x50	5	28.74	0918029
	2"x63		47.56	0918030
	3015G	<i>Līkums ar ārējo vītni</i>		
	1/2"x20	50	5.05	0918031
	3/4"x25	35	6.79	0918032
	1"x32	18	10.47	0918033
	1,1/4"x40	10	15.78	0918034
	1,1/2"x50	5	26.22	0918035
	2"x63		49.42	0918036
	3016G	<i>Trejšgabals</i>		
	20x20x20	20	10.61	0918037
	25x25x25	16	13.77	0918038
	32x32x32	8	21.73	0918039
	40x40x40	10	31.34	0918040
	50x50x50		52.67	0918041
	63x63x63		99.21	0918042
	3017G	<i>Trejšgabals ar iekšējo vītni</i>		
	20x1/2"x20	30	7.97	0918043
	25x3/4"x25	22	10.63	0918044
	32x1"x32	8	16.58	0918045
	40x1,1/4"x40	5	25.58	0918046
	50x1,1/2"x50	6	44.21	0918047
	63x2"x63		77.34	0918048
	3018G	<i>Pastiprinājums</i>		
	PP20	10	0.96	0918049
	PP25	10	1.09	0918050
	PP32	10	1.32	0918051
	PP40	10	2.23	0918052
	PP50	10	3.65	0918053
	PP63	10	6.58	0918054
	3019G	<i>Līkums ar sienas stiprinājumu</i>		
	1/2"x20	25	6.86	0918055
	3/4"x25	20	8.18	0918056
	1"x32	12	12.57	0918057
		<i>Polietilēna caurule PN12,5</i>		
	20x2,0;	100 m	1.04	2518001
	20x2,0;	500 m	0.94	2518012
	25x2,3;	100 m	1.33	2518002
	25x2,3;	500 m	1.33	2518013
	32x3,0;	100 m	1.57	2518003
	32x3,0;	500 m	1.57	2518014
	40x3,0;	100 m	2.30	4218001
	40x3,7;	100 m	2.89	2518005
	50x3,0;	100 m	2.69	4218003
	50x4,6;	100 m	4.33	2518004
	63x3,8;	100 m	4.90	2518006

GAB. EUR VEIKALS









GAB. EUR VEIKALS



		<i>Bezvītnes pāreja tērauda caurulei</i>			
	3100N				
	1/2"	10	8.14	0921095	
	3/4"	30	10.22	0921096	
	1"	20	14.86	0921097	
	1,1/4"	12	22.84	0921098	
	1,1/2"	8	27.18	0921099	
	2"	5	39.16	0921100	
		<i>Bezvītnes pāreja tērauda caurulei</i>			
	3101N				
	1/2"	10	8.42	0921101	
	3/4"	30	10.54	0921102	
	1"	20	14.86	0921103	
	1,1/4"	12	22.84	0921104	
	1,1/2"	8	27.18	0921105	
	2"	5	39.59	0921106	
		<i>Bezvītnes uzdeva tērauda caurulei</i>			
	3102N				
	1/2"	10	13.75	0921107	
	3/4"	30	16.31	0921108	
	1"	12	22.59	0921109	
	1,1/4"		32.70	0921110	
	1,1/2"	6	35.95	0921111	
	2"	4	57.61	0921112	
		<i>Montāžas plāksne jaucējkrānam</i>			
4476 B/2		20	1.47	0925335	
		<i>Montāžas plāksne jaucējkrānam</i>			
4476 B/3		20	2.26	0925336	
		<i>Montāžas plāksne ar 2 līkumiem</i>			
4476 C/6		20	9.26	0925337	
		<i>Montāžas plāksne ar 2 līkumiem</i>			
4476 C/7		20	8.57	0925339	
		<i>Tvertnes vāciņš</i>			
	DS IBC				
	1/2"		2.50	2363107	
	3/4"		2.50	2363105	
	1"		2.50	2363106	
<i>Cenas par vienu gab., bez dārza krāna</i>					

		<i>Isā vītne</i>			
	7100G				
	1/2"x50	10	2.03	0925171	
	1/2"x60	10	2.37	0925172	
	1/2"x80	10	3.21	0925173	
	1/2"x100	10	4.02	0925174	
	1/2"x120	10	4.76	0925175	
	1/2"x150	10	6.04	0925176	
	3/4"x60	10	3.63	0925177	
	3/4"x80	10	4.76	0925178	
	3/4"x100	10	6.00	0925179	
	3/4"x120	10	7.21	0925181	
	3/4"x150	10	9.06	0925180	
	1"x100	5	7.36	0925349	
1"x150	5	11.66	0925350		
		<i>Garā vītne</i>			
	7103G				
	1/2"x100	10	4.56	0925182	
	1/2"x150	10	6.19	0925183	
	1/2"x200	10	9.55	0925295	
	3/4"x100	10	6.04	0925184	
	3/4"x150	10	9.07	0925185	
	3/4"x200	10	11.92	0925296	
	1"x100	10	8.26	0925186	
	1"x150	10	12.29	0925187	
		<i>Kolektors (att. starp urb. 50mm)</i>			
	7050G				
	3/4"x2	16	13.82	0934002	
	3/4"x3	16	20.04	0934003	
	3/4"x4	16	26.46	0934004	
	3/4"x5	10	32.84	0934005	
	3/4"x6	10	39.14	0934006	
	1"x4	8	29.82	0934007	
	1"x5	8	36.80	0934008	
1"x6		45.36	0934009		
		<i>Kolektors ar ārējām vītņēm</i>			
	3740				
	3/4"x2		7.99	0634001	
	3/4"x3		11.05	0634002	
	3/4"x4		14.44	0634003	
	3/4"x5		19.99	0634004	
	1"x2		10.62	0634005	
	1"x3		13.49	0634006	
	1"x4		18.27	0634007	
1"x5		23.98	0634008		
		<i>Kolektors ar krāniem</i>			
	7002C				
	3/4"x2		14.55	0934010	
	3/4"x3		21.57	0934011	
	3/4"x4		28.90	0934012	
	1"x2		17.16	0934013	
	1"x3		25.11	0934014	
1"x4		33.53	0934015		
		<i>Kolektors ar krāniem</i>			
	3745				
	3/4"x2	5	15.97	0634009	
	3/4"x3	5	23.97	0634010	
	3/4"x4	5	30.59	0634011	
	1"x2	5	18.23	0634012	
	1"x3	5	28.45	0634013	
1"x4	5	37.43	0634014		
		<i>Kolektors ar pieslēguzgriezni</i>			
	7001 MIKY				
	3/4"x2	20	21.91	0934016	
	3/4"x3	16	29.85	0934017	
	3/4"x4	10	37.94	0934018	
	3/4"x5	10	43.81	0934019	
3/4"x6	10	53.80	0934020		
		<i>Montāžas korķis</i>			
	2135 S/Z				
	1/2"	25	0.59	3936320	

GAB. VEIKALS
EUR







GAB. VEIKALS
EUR







	5001	<i>Līkums I-Ā gar. 90°</i>		
	12	10	1.03	7033001
	15	10	0.57	7033002
	18	10	1.32	7033003
	22	10	1.55	7033004
	28	10	4.38	7033005
	35	10	7.65	7033190
	5002	<i>Līkums I-I gar. 90°</i>		
	12	10	0.71	7033006
	15	10	0.59	7033007
	18	10	0.86	7033008
	22	10	1.33	7033009
	28	10	2.05	7033010
	35	10	7.01	7033191
	5040	<i>Līkums I-Ā 45°</i>		
	12	10	1.49	7033011
	15	10	0.47	7033012
	18	10	1.60	7033013
	22	10	1.55	7033014
	28	10	3.03	7033015
	35	10	6.56	7033202
	5041	<i>Līkums I-I 45°</i>		
	12	10	2.12	7033016
	15	10	0.59	7033017
	18	10	1.42	7033018
	22	10	1.61	7033019
	28	10	2.94	7033020
	35	10	6.21	7033192
	5085	<i>Pārliiekums</i>		
	12	10	4.48	7033021
	15	10	3.37	7033022
	18	10	9.37	7033023
	22	10	7.82	7033024
	5086	<i>Puspārliiekums</i>		
	12	10	4.02	7033025
	15	10	3.09	7033026
	18	10	4.91	7033027
	22	10	6.78	7033028
	5090	<i>Līkums I-I 90°</i>		
	12	10	0.62	7033029
	15	10	0.50	7033030
	18	10	0.71	7033031
	22	10	1.16	7033032
	28	10	2.14	7033033
	35	10	8.56	7033193
	5092	<i>Līkums I-Ā 90°</i>		
	12	10	0.82	7033034
	15	10	0.63	7033035
	18	10	1.31	7033036
	22	10	2.23	7033037
	28	10	3.48	7033038
	35	10	8.48	7033194

















	5130	<i>Treigabals</i>		
	12	10	1.30	7033039
	15	10	0.79	7033040
	18	10	1.50	7033041
	22	10	2.61	7033042
	28	10	4.86	7033043
	35	10	12.66	7033203
	5130	<i>Treigabals-pāreja</i>		
	15*12*12	10	1.51	7033044
	15*12*15	10	1.19	7033045
	15*15*12	10	1.93	7033046
	15*18*15	10	2.94	7033047
	15*22*15	10	3.85	7033048
	18*12*12	10	4.23	7033049
	18*12*15	10	7.61	7033050
	18*12*18	10	3.31	7033051
	18*15*12	10	4.85	7033052
	18*15*15	10	1.42	7033053
	18*15*18	10	1.76	7033054
	18*18*12	10	4.04	7033055
	18*18*15	10	1.71	7033056
	18*22*18	10	4.02	7033057
	22*12*18	10	6.91	7033058
	22*12*22	10	2.57	7033059
	22*15*15	10	2.61	7033060
	22*15*18	10	4.49	7033061
	22*15*22	10	2.10	7033062
	22*18*15	10	5.74	7033063
	22*18*18	10	3.11	7033064
	22*18*22	10	3.39	7033065
	22*22*15	10	6.16	7033066
22*22*18	10	7.23	7033067	
28*15*15	10	7.03	7033068	
28*15*22	10	6.80	7033069	
28*15*28	10	5.07	7033070	
28*18*15	10	12.66	7033071	
28*18*18	10	18.33	7033072	
28*18*22	10	6.78	7033073	
28*18*28	10	8.25	7033074	
28*22*15	10	10.75	7033075	
28*22*18	10	6.76	7033076	
28*22*22	10	5.54	7033077	
28*22*28	10	5.15	7033078	
28*28*15	10	10.65	7033079	
28*28*18	10	9.23	7033080	
28*28*22	10	7.33	7033081	
35*22*22	10	19.55	7033208	
35*28*35	10	12.66	7033195	
35*35*28	10	21.11	7033209	

GAB. EUR VEIKALS

GAB. EUR VEIKALS

	5243		<i>Mufe ar pāreju I-Ā</i>	
	15*12	10	0.72	7033082
	18*12	10	0.70	7033083
	18*15	10	0.64	7033084
	22*12	10	1.57	7033085
	22*15	10	1.15	7033086
	22*18	10	1.22	7033087
	28*15	10	4.24	7033088
28*18	10	4.77	7033089	
28*22	10	1.94	7033090	
	5240		<i>Mufe ar pāreju I-I</i>	
	15*12	10	1.06	7033091
	18*12	10	0.95	7033092
	18*15	10	0.90	7033093
	22*15	10	2.41	7033094
	22*18	10	1.50	7033095
	28*15	10	2.97	7033096
	28*18	10	2.93	7033097
28*22	10	2.37	7033098	
35*22	10	5.93	7033196	
	5270		<i>Mufe</i>	
	12	10	0.33	7033099
	15	10	0.32	7033100
	18	10	0.40	7033101
	22	10	0.64	7033102
	28	10	1.52	7033103
	5301		<i>Korķis</i>	
	12	10	1.17	7033104
	15	10	0.92	7033105
	18	10	1.10	7033106
	22	10	1.93	7033107
	28	10	3.61	7033108
	<i>Kapara caurule cietā 5 m (1 mm)</i>			
	99B12		8.47	7033214
	99B15		13.72	7033215
	99B18		16.79	7033216
	99B22		21.56	7033217
	99B28		28.84	7033218
	99B35		37.01	7033219
	<i>Kapara caurule mīkstā rullī 25m</i>			
	99A10	50	6.04	7033211
	99A12	50	7.23	7033212
	99A15	25	8.43	7033213
	<i>Birstūte kapara cauruļu tīrīšanai</i>			
	15mm	12	4.15	1735002
	18mm	12	3.84	1735003
	22mm	12	4.02	1735004
28mm	12	5.85	1735005	

	5001C		<i>Švammīte cauruļu tīrīšanai</i>	
	10		5.02	1735001
	331184		<i>PE cauruļu gala frēze</i>	
	20-63 mm		19.06	2535030
	4476C/7		<i>Montāžas plāksne</i>	
	1/2"*15mm	20	8.57	0925339
	<i>Alva lodēšanai SN9</i>			
	100 gr	815708	20.88	6735004
	<i>Kusnis lodēšanai ar alvu "HAMPTON"</i>			
	Kusnis lodēšanai ar alvu. Satur cinka hlorīdu. Paredzēts dzelzs, tērauda, čuguna, vara, bronzas, misiņa, cinka u.c. metālu lodēšanai izņemot alumīniju! Aktivizējas pie +75°C līdz +375°C.			
175 gr	100111	11.48	6735002	
<i>Cauruļu izolācija</i>				
	110022	15/9	0.53	3081001
	110042	18/9	0.55	3081002
	110062	22/9	0.59	3081003
		25/9	0.71	3081013
	110101	28/9	0.71	3081004
	110142	35/9	0.80	3081005
	110159	42/9	0.95	3081008
	110172	48/9	1.15	3081010
	110201	54/9	1.39	3081009
	110246	60/9	1.43	3081006
	110225	76/9	3.43	3081007
		15/13		
		18/13		
	82012022	22/13	0.94	5081001
	82013028	28/13	1.11	5081002
82013035	35/13	1.49	5081003	
82013042	42/13	1.53	5081004	
	48/13			
82013054	54/13	2.01	5081008	
82013063	63/13	2.40	5081005	
<i>Auduma, mitrumizturīga limenta, pelēka (Folsen)</i>				
	48mmx50m		8.06	2566019
	50mmx50m		6.94	2566021









	4090G	<i>Līkums IV 90°</i>	
	12*1/2"	10	1.67 7033109
	15*1/2"	10	2.29 7033110
	15*3/4"	10	2.35 7033111
	18*1/2"	10	3.07 7033112
	18*3/4"	10	4.66 7033113
	22*1/2"	10	2.94 7033114
	22*3/4"	10	5.17 7033115
	22*1"	10	7.14 7033116
	28*3/4"	10	8.38 7033117
28*1"	10	8.69 7033118	
	4092G	<i>Līkums AV 90°</i>	
	12*1/2"	10	2.08 7033119
	15*1/2"	10	2.17 7033120
	18*1/2"	10	3.93 7033121
	15*3/4"	10	4.59 7033122
	18*3/4"	10	5.54 7033123
	22*3/4"	10	5.71 7033124
	22*1"	10	9.14 7033125
28*1"	10	7.88 7033126	
	4096G	<i>Lod. savienojums ar piesl. IV</i>	
	15*1/2"	10	4.68 7033127
	18*1/2"	10	10.68 7033128
	22*3/4"	10	19.87 7033129
28*1"	10	20.41 7033130	
	4098G	<i>Lod. savienojums ar piesl. AV</i>	
	15*1/2"	10	2.86 7033131
	18*1/2"	10	8.18 7033132
	22*3/4"	10	8.91 7033133
28*1"	10	10.61 7033134	
	4130G	<i>Trejgabals IV</i>	
	12*1/2"*12	10	2.40 7033135
	15*1/2"*15	10	2.03 7033136
	15*3/4"*15	10	6.62 7033137
	18*1/2"*18	10	3.74 7033138
	18*3/4"*18	10	4.13 7033139
	22*1/2"*22	10	8.46 7033140
	22*3/4"*22	10	6.05 7033141
	28*1/2"*28	10	7.78 7033142
28*3/4"*28	10	14.86 7033143	
28*1"*28	10	14.76 7033144	
	4243G	<i>Pāreja AV</i>	
	10*3/8	10	4.03 7033206
	12*1/2"	10	1.60 7033145
	15*1/2"	10	1.13 7033146
	15*3/4"	10	1.55 7033147
	18*1/2"	10	1.52 7033148
	18*3/4"	10	1.86 7033149
	22*1/2"	10	2.89 7033150
	22*3/4"	10	2.25 7033151
	22*1"	10	2.80 7033152
	28*3/4"	10	4.95 7033153
28*1"	10	3.24 7033154	
35*1"	10	7.00 7033198	
35*1 1/4"	10	5.79 7033199	
	4340	<i>Lod. savienojums ar piesl.</i>	
	12	10	4.55 7033155
	15	10	6.96 7033156
	18	10	8.12 7033157
	22	10	12.69 7033158
28	10	21.82 7033159	
	4472G	<i>Līkums ar sienas stiprinājumu</i>	
	12*1/2"	10	3.20 7033186
	15*1/2"	10	2.11 7033187
	18*1/2"	10	2.28 7033188
22*3/4"	10	5.32 7033189	
	4270G	<i>Pāreja IV</i>	
	12*1/2"	10	2.24 7033160
	15*1/2"	10	1.61 7033161
	15*3/4"	10	4.45 7033162
	18*1/2"	10	2.20 7033163
	18*3/4"	10	3.71 7033164
	22*1/2"	10	3.12 7033165
22*3/4"	10	3.19 7033166	
22*1"	10	4.17 7033167	
28*3/4"	10	6.28 7033168	
28*1"	10	4.80 7033169	
35*1"	10	9.76 7033200	
35*1 1/4"	10	9.24 7033201	
	4340G	<i>Lod. savienojums ar piesl. IV</i>	
	12*1/2"	10	10.41 7033170
	15*1/2"	10	8.34 7033171
	15*3/4"	10	9.86 7033172
	18*1/2"	10	13.42 7033173
	18*3/4"	10	9.13 7033174
	22*3/4"	10	11.41 7033175
22*1"	10	15.09 7033176	
28*1"	10	17.42 7033177	
	4341G	<i>Lod. savienojums ar piesl. AV</i>	
	12*1/2"	10	4.48 7033178
	15*1/2"	10	7.74 7033179
	15*3/4"	10	11.52 7033180
	18*1/2"	10	7.99 7033181
	18*3/4"	10	6.60 7033182
	22*3/4"	10	10.05 7033183
22*1"	10	11.21 7033184	
28*1"	10	17.65 7033185	
	<i>Kapara caurule cietā 5m</i>		
	99B12	1 mm	8.47 7033214
	99B15	1 mm	13.72 7033215
	99B18	1 mm	16.79 7033216
	99B22	1 mm	21.56 7033217
	99B28	1 mm	28.84 7033218
	99B35	1 mm	37.01 7033219
	<i>Kapara caurule mīkstā rullī 25m</i>		
	99A10	50	6.04 7033211
	99A12	50	7.23 7033212
99A15	25	8.43 7033213	
	<i>Birstīte kapara cauruļu tīrīšanai</i>		
	15mm	1026	12 4.15 1735002
	18mm	1027	12 3.84 1735003
	22mm	1028	12 4.02 1735004
	28mm	1029	12 5.85 1735005
	<i>Svammīte cauruļu tīrīšanai</i>		
		10	5.02 1735001
	<i>PE cauruļu gala frēze</i>		
	20-63 mm		19.06 2535030
	<i>Montāžas plāksne</i>		
	1/2"*15mm	20	8.57 0925339











VEIKALS

GAB. **EUR**

VEIKALS

GAB. **EUR** **ITĀLIJA**

7250		<i>Kompresijas savienojums ar ārējo vītņi</i>			
	1/2"x16	10	2.35	0919067	
	1/2"x20	10	3.38	0919068	
	3/4"x16	10	3.21	0919069	
	3/4"x20	10	3.72	0919070	
	3/4"x26	5	6.57	0919071	
	1"x26	5	7.45	0919072	
	1"x32	5	11.74	0919073	
7251		<i>Kompresijas savienojums ar iekšējo vītņi</i>			
	1/2"x16	10	2.60	0919074	
	1/2"x20	10	3.74	0919075	
	3/4"x16	10	3.76	0919076	
	3/4"x20	10	4.00	0919077	
	3/4"x26	5	6.81	0919078	
	1"x26	5	7.45	0919079	
	1"x32	5	11.45	0919080	
7252		<i>Kompresijas uzdeva</i>			
	16x16	10	4.17	0919081	
	20x20	10	6.47	0919082	
	26x26	10	11.12	0919083	
	32x32	5	19.67	0919084	
7256		<i>Kompresijas trejgabals</i>			
	16x16x16	10	6.51	0919085	
	20x20x20	5	9.61	0919086	
	20x16x20	5	11.71	0919087	
	20x16x16	5	4.98	0919088	
	20x20x16	5	5.53	0919089	
	26x26x26	5	16.34	0919090	
	26x20x26	5	8.40	0919091	
	26x26x20	5	8.22	0919092	
	32x32x32	5	26.29	0919093	
7257		<i>Kompresijas trejgabals ar iekšējo vītņi</i>			
	16x1/2"x16	10	5.31	0919094	
	20x1/2"x20	5	7.74	0919095	
	20x3/4"x20	5	7.98	0919096	
	26x3/4"x26	5	13.60	0919097	
	26x1"x26	5	17.71	0919098	
	32x1"x32	5	20.46	0919099	
7258		<i>Kompresijas trejgabals ar ārējo vītņi</i>			
	16x1/2"x16	10	7.16	0919100	
	20x1/2"x20	10	7.71	0919101	
	20x3/4"x20	5	11.11	0919102	
	26x3/4"x26	5	17.46	0919103	
	26x1"x26	5	18.24	0919104	
7253		<i>Kompresijas līkums</i>			
	16x16	10	4.79	0919105	
	20x20	10	6.45	0919106	
	26x26	5	11.14	0919107	
	32x32	5	18.97	0919108	
7254		<i>Kompresijas līkums ar iekšējo vītņi</i>			
	1/2"x16	10	3.51	0919109	
	1/2"x20	10	4.53	0919110	
	3/4"x16	10	4.67	0919111	
	3/4"x20	10	5.09	0919112	
	3/4"x26	5	9.17	0919113	
	1"x26	5	10.19	0919114	
	1"x32	5	11.92	0919115	







7255		<i>Kompresijas līkums ar ārējo vītņi</i>			
	1/2"x16	10	3.42	0919116	
	1/2"x20	10	4.84	0919117	
	3/4"x16	10	4.53	0919118	
	3/4"x20	10	4.67	0919119	
	3/4"x26	5	8.28	0919120	
	1"x26	5	10.63	0919121	
	1"x32	5	11.92	0919122	
7259		<i>Kompresijas līkums ar sienas stiprinājumu</i>			
	1/2"x16	10	3.96	0919123	
	1/2"x20	10	5.04	0919124	
	3/4"x16	5	5.83	0919125	
	3/4"x20	5	6.43	0919126	
7260		<i>Kompresijas pāreja ar saskrūvi</i>			
	1/2"x16	20	6.53	0919127	
7010N		<i>Eirokonusa pieslēgs</i>			
	16x2.0x1/2"	10	3.20	0919128	
	20x2.0x3/4"	10	3.91	0919129	
3813 M		<i>Kalibrators</i>			
	D16	1	11.39	6435003	
	D20	1	6.94	6435001	
	D26	1	6.94	6435002	
	D12-16	1	11.45	6435005	
3813M		<i>Kalibrators D12-D26</i>			
		1	9.52	6435004	
3813		<i>Kalibrators</i>			
			3.53	0935001	
7271		<i>PEX-AL-PEX caurule Itālija</i>			
	16x2,0	100 m	1.47	0919130	
	20x2,0	100 m	2.19	0919131	
	26x3.0	50 m	4.14	0919132	
7271F		<i>PEX-AL-PEX caurule Ķīna</i>			
	26x3.0	50 m	1.63	9519037	
8595/96		<i>Liekšanas spirāle, ārējā</i>			
	16mm		5.14	2135001	
	20mm		8.61	2135002	











VEIKALS











VEIKALS









GAB. EUR

GAB. EUR ITĀLIJA









	7230	<i>Presējams savienojums ar ārējo vītņi</i>			
	1/2"x16	10	2.45	0919001	
	1/2"x20	10	2.95	0919002	
	3/4"x16	10	3.06	0919003	
	3/4"x20	10	3.48	0919004	
	3/4"x26	5	4.63	0919005	
	1"x26	5	6.38	0919006	
	1"x32	5	8.15	0919007	
	7231	<i>Presējams savienojums ar iekšējo vītņi</i>			
	1/2"x16	10	2.44	0919008	
	1/2"x20	10	2.85	0919009	
	3/4"x16	10	3.99	0919010	
	3/4"x20	10	3.49	0919011	
	3/4"x26	5	5.43	0919012	
	1"x26	5	6.79	0919013	
	1"x32	5	8.42	0919014	
	7232	<i>Presējama uzmava</i>			
	16x16	10	2.92	0919015	
	20x20	10	3.66	0919016	
	26x26	5	7.20	0919017	
	32x32	5	10.87	0919018	
	20x16	10	3.81	0919019	
26x20	5	7.06	0919020		
32x26	5	10.87	0919021		
	7236	<i>Presējams trejgabals</i>			
	16x16x16	10	4.64	0919022	
	20x20x20	5	6.75	0919023	
	26x26x26	2	12.23	0919024	
	32x32x32	2	19.70	0919025	
	20x16x16	5	7.47	0919026	
	20x16x20	5	7.47	0919027	
	20x20x16	5	7.47	0919028	
	20x26x20	5	12.23	0919029	
	26x16x26	5	12.23	0919030	
	26x20x20	5	12.23	0919031	
	26x20x26	5	12.23	0919032	
	26x26x20	5	12.23	0919033	
	32x20x32	2	20.38	0919034	
32x26x32	2	20.65	0919035		
	7237	<i>Presējams trejgabals ar iekšējo vītņi</i>			
	16x1/2"x16	5	4.85	0919036	
	20x1/2"x20	5	6.41	0919037	
	20x3/4"x20	5	6.97	0919038	
	26x3/4"x26	5	10.87	0919039	
	26x1"x26	5	11.56	0919040	
	32x1"x32	2	16.30	0919041	
	7238	<i>Presējams trejgabals ar ārējo vītņi</i>			
	16x1/2"x16	5	4.95	0919042	
	20x1/2"x20	5	7.20	0919043	
	26x3/4"x26	5	10.87	0919044	
	26x1"x26	5	12.39	0919045	
32x1"x32	5	16.85	0919046		
	7233	<i>Presējams līkums</i>			
	16x16	10	3.25	0919047	
	20x20	5	4.57	0919048	
	26x26	5	8.56	0919049	
32x32	5	11.55	0919050		







	7234	<i>Presējams līkums ar iekšējo vītņi</i>			
	1/2"x16	10	3.30	0919051	
	1/2"x20	10	4.04	0919052	
	3/4"x20	10	5.48	0919053	
	3/4"x26	5	7.60	0919054	
	1"x26	5	8.68	0919055	
	1"x32	2	10.05	0919056	
	7235	<i>Presējams līkums ar ārējo vītņi</i>			
	1/2"x16	10	3.27	0919057	
	1/2"x20	10	4.08	0919058	
	3/4"x20	10	5.48	0919059	
	3/4"x26	5	7.60	0919060	
	1"x26	5	8.68	0919061	
1"x32	2	10.46	0919062		
	7239	<i>Presējams līkums ar sienas stiprinājumu</i>			
	1/2"x16	5	4.18	0919063	
1/2"x20	5	5.43	0919064		
	7246	<i>Presējama pāreja, saskrūve</i>			
	1/2"x16	10	3.78	0919065	
1/2"x20	10	5.01	0919066		
	3813 M	<i>Kalibrators</i>			
	D16	1	11.39	6435003	
	D20	1	6.94	6435001	
	D26	1	6.94	6435002	
D12-16	1	11.45	6435005		
	3813M	<i>Kalibrators D12-D26</i>			
		1	9.52	6435004	
	3813	<i>Kalibrators</i>			
			3.53	0935001	
	7271	<i>PEX-AL-PEX caurule Itālija</i>			
	16x2,0	100 m	1.47	0919130	
	20x2,0	100 m	2.19	0919131	
	26x3,0	50 m	4.14	0919132	
	7271F	<i>PEX-AL-PEX caurule Ķīna</i>			
	26x3,0	50 m	1.63	9519037	
	8595/96	<i>Liekšanas spirāle, ārējā</i>			
	16mm		5.14	2135001	
20mm		8.61	2135002		

















			GAB.	EUR		
	3901F	<i>Kompresijas savienojums ar ārējo vītņi</i>				
	3/4"x16	46	1.62	0.98	9519017	
	1"x26	73	2.76	1.67	6419034	
	3902F	<i>Kompresijas savienojums ar iekšējo vītņi</i>				
	1"x26	38	2.85	1.73	6419036	
	3903F	<i>Kompresijas uzstāve</i>				
	16x20	274	2.52	1.53	9519020	
	26x26	41	3.94	2.39	6419037	
	3931F	<i>Kompresijas trejgabals</i>				
	20x16x20	685	3.35	2.03	9519010	
	16x20x16	868	3.53	2.14	9519022	
	20x16x16	920	3.53	2.14	9519023	
	20x20x16	926	4.03	2.44	9519024	
	26x20x26	40	8.28	5.02	6419039	
	26x26x26	34	5.53	3.35	6419038	
	3932F	<i>Kompresijas trejgabals ar iekšējo vītņi</i>				
	16x3/4"x16	916	3.35	2.03	9519031	
	20x3/4"x20	430	4.34	2.63	9519032	
	26x3/4"x26	32	4.93	2.99	6419043	
	26x1"x26	40	5.33	3.23	6419044	
	3933F	<i>Kompresijas trejgabals ar ārējo vītņi</i>				
	16x3/4"x16	921	2.85	1.73	9519015	
	20x3/4"x20	589	4.34	2.63	9519016	
	26x3/4"x26	35	4.36	2.64	6419045	
	26x1"x26	40	5.33	3.23	6419046	
	3952F	<i>Kompresijas līkums ar iekšējo vītņi</i>				
	3/4"x16	705	2.16	1.31	9519028	
	3/4"x26	63	3.09	1.87	6419040	
	1"x26	60	3.65	2.21	6419041	
	3953F	<i>Kompresijas līkums ar ārējo vītņi</i>				
	3/4"x16	713	1.98	1.20	9519012	
	3/4"x20	336	2.48	1.50	9519014	
	3/4"x26	50	2.85	1.73	6419047	
	1"x26	49	3.25	1.97	6419048	
	3954F	<i>Kompresijas līkums ar sienas stiprinājumu</i>				
	1/2"x20	98	2.51	1.52	6419030	
	3/4"x16	45	2.46	1.49	6419029	
	4002 F	<i>Presējams savienojums ar iekšējo vītņi</i>				
	1/2"x16	64	1.55	0.94	6419003	

			GAB.	EUR		
	4033 F	<i>Presējams trejgabals ar ārējo vītņi</i>				
	16x1/2"x16	41	2.52	1.53	6419024	
	3813 M	<i>Kalibrators</i>				
	D16	1	11.39		6435003	
	D20	1	6.94		6435001	
	D26	1	6.94		6435002	
	D12-16	1	11.45		6435005	
	3813	<i>Kalibrators</i>				
		1	3.53		0935001	
	921 PPR	<i>Skēres caurulēm 0-42mm nerūsējoša tērauda asmenis</i>				
			14.73		3435001	
			14.46		3435002	
	100902	<i>Prese DI6-32, mehāniskā</i>				
					U-gali 16-32	
					TH-gali 16-32	
		16-32	1	200.33	8235010	
	3811 F	<i>Prese DI6-20, mehāniskā</i>				
		16-20	1	148.00	7635013	
	7271F	<i>PEX-AL-PEX caurule Ķīna</i>				
		26x3.0	50 m	1.63	9519037	
	7271	<i>PEX-AL-PEX caurule Itālija</i>				
		16x2.0	100 m	1.47	0919130	
		20x2.0	100 m	2.19	0919131	
		26x3.0	50 m	4.14	0919132	
	8595/96	<i>Liekšanas spirāle, ārējā</i>				
		16mm		5.14	2135001	
		20mm		8.61	2135002	















Čuguna veidgabali

		GAB.	EUR	VEIKALS	
	85 M				<i>Apeja</i>
	1/2"	10	2.79	2124001	
	3/4"	10	4.14	2124002	
	1"	10	12.58	2124003	
	90 M				<i>Līkums (I-I)</i>
	1/2"	10	0.78	2124004	
	3/4"	10	1.07	2124005	
	1"	10	1.59	2124006	
	1,1/4"		3.09	2124007	
	1,1/2"	22	5.04	2124008	
	2"		5.88	2124009	
	90 M				<i>Līkums ar pāreju</i>
	3/4"x1/2"	10	1.54	2124010	
	1"x1/2"	10	2.11	2124011	
	1"x3/4"	10	2.27	2124012	
	1,1/4"x1/2"		4.28	2124013	
	1,1/4"x3/4"		5.84	2124014	
	1,1/4"x1"		4.65	2124015	
	1,1/2"x1"		7.38	2124016	
	1,1/2"x1,1/4"		6.75	2124017	
2"x1,1/4"		13.75	2124018		
2"x1,1/2"		9.75	2124019		
	120 M				<i>Līkums 45° (I-I)</i>
	1/2"	10	2.94	2124020	
	3/4"	10	4.02	2124021	
	1"	10	4.55	2124022	
	92 M				<i>Līkums (I-Ā)</i>
	1/2"	10	0.83	2124023	
	3/4"	10	1.23	2124024	
	1"	10	2.07	2124025	
	1,1/4"		3.64	2124026	
	1,1/2"	22	5.52	2124027	
	2"	12	7.15	2124028	
	121 M				<i>Līkums 45° (I-A)</i>
	1/2"	10	2.89	2124029	
	3/4"	10	3.74	2124030	
	1"	10	5.68	2124031	
	130 M				<i>Trejšgabals</i>
	1/2"	10	1.10	2124032	
	3/4"	10	1.59	2124033	
	1"	10	2.44	2124034	
	1,1/4"		4.21	2124035	
	1,1/2"		6.53	2124036	
	2"	10	9.31	2124037	
	130 M				<i>Trejšgabals - pāreja</i>
	1/2"x3/4"	10	2.07	2124038	
	3/4"x1/2"	10	1.63	2124039	
	1"x1/2"	10	2.21	2124040	
	1"x3/4"	10	2.41	2124041	
	1,1/4"x1/2"		3.78	2124042	
	1,1/4"x3/4"		4.02	2124043	
	1,1/4"x1"		4.42	2124044	
	1,1/2"x1/2"		5.04	2124045	
1,1/2"x3/4"		5.33	2124046		
	1,1/2"x1"		6.00	2124047	







	130 M				<i>Trejšgabals - pāreja</i>
	1,1/2"x1,1/4"		7.93	2124048	
	2"x1/2"		8.44	2124049	
	2"x3/4"		9.89	2124050	
	2"x1"		7.50	2124051	
	2"x1,1/4"		9.63	2124052	
	2"x1,1/2"		11.53	2124053	
	290 M				<i>Korkis (AV)</i>
	1/2"	10	0.65	2124054	
	3/4"	10	0.76	2124055	
	1"	10	0.84	2124056	
	1,1/4"	10	1.54	2124057	
	1,1/2"	10	1.87	2124058	
	2"		3.42	2124059	
	300 M				<i>Korkis (IV)</i>
	1/2"	10	0.92	2124060	
	3/4"	10	1.07	2124061	
	1"	10	1.24	2124062	
	1,1/4"	10	1.94	2124063	
	1,1/2"	10	2.42	2124064	
	2"		4.56	2124065	
	270 M				<i>Uzmava</i>
	1/2"	10	0.79	2124066	
	3/4"	10	1.06	2124067	
	1"	10	1.38	2124068	
	1,1/4"		2.25	2124069	
	1,1/2"		3.08	2124070	
	2"		4.72	2124071	
	240 M				<i>Uzmava - pāreja</i>
	3/4"x1/2"	10	1.32	2124072	
	1"x1/2"	10	1.74	2124073	
	1"x3/4"	10	1.56	2124074	
	1,1/4"x1/2"	10	3.34	2124075	
	1,1/4"x3/4"	10	3.03	2124076	
	1,1/4"x1"	10	2.82	2124077	
	1,1/2"x1/2"		7.32	2124078	
	1,1/2"x3/4"		6.45	2124079	
	1,1/2"x1"		3.57	2124080	
	1,1/2"x1,1/4"		3.94	2124081	
	2"x1/2"		10.05	2124082	
	2"x3/4"		7.55	2124083	
	2"x1"		6.92	2124084	
	2"x1,1/4"		6.20	2124085	
	2"x1,1/2"		5.86	2124086	
	280 M				<i>Nipelis</i>
	1/2"	10	0.72	2124087	
	3/4"	10	1.00	2124088	
	1"	10	1.33	2124089	
	1,1/4"	10	2.28	2124090	
	1,1/2"	10	2.68	2124091	
	2"		4.86	2124092	
	245 M				<i>Nipelis reducēts</i>
	3/4"x1/2"	10	1.40	2124093	
	1"x1/2"	10	2.96	2124094	
	1"x3/4"	10	1.57	2124095	
	1,1/4"x1/2"	10	6.22	2124096	
	1,1/4"x3/4"	10	5.36	2124097	
	1,1/4"x1"	10	2.68	2124098	
	1,1/2"x3/4"		5.36	2124099	









		GAB.	EUR	VEIKALS			GAB.	EUR	VEIKALS	
	245 M	<i>Nipelis reducēts</i>								
		1,1/2"x1"		8.53	2124100					
		1,1/2"x1,1/4"		3.68	2124101					
		2"x1"		7.69	2124102					
		2"x1,1/4"		6.96	2124103					
		2"x1,1/2"		6.39	2124104					
	241 M	<i>Vītņu pāreja (Ā-I)</i>								
		1/2"x3/8"		0.26	2124105					
		3/4"x1/2"	10	0.73	2124106					
		1"x1/2"	10	1.05	2124107					
		1"x3/4"	10	0.94	2124108					
		1,1/4"x1/2"	10	1.84	2124109					
		1,1/4"x3/4"	10	1.59	2124110					
		1,1/4"x1"	10	1.14	2124111					
		1,1/2"x1/2"	10	2.34	2124112					
		1,1/2"x3/4"	10	2.55	2124113					
		1,1/2"x1"	10	1.71	2124114					
		1,1/2"x1,1/4"	10	1.79	2124115					
		2"x1/2"	10	4.72	2124116					
		2"x3/4"		4.67	2124117					
	2"x1"		3.86	2124118						
	2"x1,1/4"		3.63	2124119						
	2"x1,1/2"		3.29	2124120						
	529 M	<i>Pagarinātājs</i>								
		1/2"	10	1.43	2124121					
		3/4"	10	2.14	2124122					
		1"	10	4.16	2124123					
	246 M	<i>Vītņu pāreja</i>								
		3/4"x1/2"	10	1.73	2124124					
		1"x1/2"	10	2.88	2124125					
		1"x3/4"	10	2.96	2124126					
		1,1/4"x1/2"	10	7.83	2124127					
		1,1/4"x3/4"	10	5.54	2124128					
		1,1/4"x1"	10	3.98	2124129					
		1,1/2"x3/4"		6.69	2124130					
		1,1/2"x1"		7.55	2124131					
		1,1/2"x1,1/4"		6.68	2124132					
		2"x1"		11.78	2124133					
	2"x1,1/4"		9.00	2124134						
	2"x1,1/2"		9.45	2124135						
	330 M	<i>Izjaucams savienojums (I-I)</i>								
		1/2"	10	2.78	2124136					
		3/4"	10	3.26	2124137					
		1"	10	3.68	2124138					
		1,1/4"		6.28	2124139					
	1,1/2"		8.06	2124140						
	2"		13.27	2124141						
	331 M	<i>Izjaucams savienojums (I-A)</i>								
		1/2"	10	3.53	2124142					
		3/4"	10	3.91	2124143					
		1"	10	4.73	2124144					
		1,1/4"		8.35	2124145					
		1,1/2"		10.07	2124146					
	2"		15.82	2124147						
	03576	<i>Gumijas blīve izjaucamiem savienojumiem</i>								
		1/2"	100	0.32	2166001					
		3/4"	100	0.28	2166002					
		1"	100	0.46	2166003					
		1,1/2"	100	0.66	2166004					
		1,1/4"	100	0.74	2166005					
	2"	100	0.68	2166006						
	340 M	<i>Izjaucams savienojums (konuss (I-I))</i>								
		1/2"	10	3.54	2124148					
		3/4"	10	4.03	2124149					
		1"	10	4.61	2124150					
		1,1/4"		7.60	2124151					
		1,1/2"		8.93	2124152					
	2"		14.65	2124153						
	341 M	<i>Izjaucams savienojums (konuss (I-A))</i>								
		1/2"	10	3.45	2124154					
		3/4"	10	4.19	2124155					
		1"	10	5.15	2124156					
		1,1/4"		8.19	2124157					
		1,1/2"		10.39	2124158					
	2"		16.62	2124159						
	95 M	<i>Izjaucams savienojums (I-I)</i>								
		1/2"		4.96	2124160					
		3/4"		5.97	2124161					
		1"		7.39	2124162					
		1,1/4"		15.62	2124163					
		1,1/2"		21.77	2124164					
	2"		32.51	2124165						
	96 M	<i>Izjaucams savienojums (I-A)</i>								
		1/2"		5.55	2124166					
		3/4"		6.67	2124167					
		1"		8.48	2124168					
		1,1/4"		17.48	2124169					
		1,1/2"		23.73	2124170					
	2"		34.43	2124171						
	93 M	<i>Savienojuma komplekts sūkņim</i>								
		1"		6.37	2124172					
		1,1/4"		8.13	2124173					
	180 M	<i>Krusts</i>								
		1/2"	10	4.41	2124174					
		3/4"	10	6.68	2124175					
		1"		8.14	2124176					
		1,1/4"		10.43	2124177					
		1,1/2"		15.06	2124178					
	2"		22.86	2124179						
	310 M	<i>Kontruzgrieznis</i>								
		1/2"		0.84	2124180					
		3/4"		0.85	2124181					
		1"		1.13	2124182					
		1,1/4"		1.66	2124183					
		1,1/2"		1.94	2124184					
	2"		3.47	2124185						
	291 M	<i>Korķis radiatoram kreisā vītne</i>								
		1,1/4"x1/2"		1.50	2124407					
		1,1/4"x3/4"		1.50	2124408					
		1,1/4"x1/2"		1.50	2124410					
	291 M	<i>Korķis radiatoram labā vītne</i>								
		1,1/4"x3/4"		1.50	2124411					
		1,1/4"		1.50	2124409					
		<i>Korķis radiatoram kreisā vītne</i>								
	1,1/4"		1.50	2124406						

Cinkoti čuguna veidgabali

		GAB.	EUR	VEIKALS		
	85 C			<i>Apeja</i>		
	1/2"	10	3.37	2124186		
	3/4"	10	5.24	2124187		
	1"	10	13.83	2124188		
	90 C			<i>Līkums (I-I)</i>		
	1/2"	10	1.02	2124189		
	3/4"	10	1.46	2124190		
	1"	10	2.14	2124191		
	1,1/4"		3.89	2124192		
	1,1/2"	22	6.30	2124193		
	90 C			<i>Līkums ar pāreju</i>		
	3/4"x1/2"	10	1.92	2124195		
	1"x1/2"	10	2.71	2124196		
	1"x3/4"	10	2.88	2124197		
	1,1/4"x1/2"		5.33	2124198		
	1,1/4"x3/4"		7.00	2124199		
	1,1/4"x1"		5.58	2124200		
	1,1/2"x1"		8.45	2124201		
	1,1/2"x1,1/4"		8.92	2124202		
	2"x1,1/4"		17.68	2124203		
	120 C			<i>Līkums 45° (I-I)</i>		
	1/2"	10	3.37	2124205		
	3/4"	10	4.25	2124206		
	1"	10	5.08	2124207		
	92 C			<i>Līkums (I-Ā)</i>		
	1/2"	10	1.10	2124208		
	3/4"	10	1.76	2124209		
	1"	10	2.71	2124210		
	1,1/4"		4.64	2124211		
	1,1/2"	22	6.87	2124212		
	121 C			<i>Līkums 45° (I-A)</i>		
	1/2"	10	3.42	2124214		
	3/4"	10	4.74	2124215		
	1"	10	6.90	2124216		
	130 C			<i>Trejšgabals</i>		
	1/2"	10	1.47	2124217		
	3/4"	10	2.14	2124218		
	1"	10	3.34	2124219		
	1,1/4"		5.43	2124220		
	1,1/2"		8.28	2124221		
	130 C			<i>Trejšgabals - pāreja</i>		
	1/2"x3/4"	10	4.94	2124223		
	3/4"x1/2"	10	2.17	2124224		
	1"x1/2"	10	2.87	2124225		
	1"x3/4"	10	3.16	2124226		
	1,1/4"x1/2"		4.81	2124227		
	1,1/4"x3/4"		4.99	2124228		
	1,1/4"x1"		5.61	2124229		
	1,1/2"x1/2"		6.32	2124230		
	1,1/2"x3/4"		6.73	2124231		
1,1/2"x1"		7.51	2124232			
	130 C			<i>Trejšgabals - pāreja</i>		
	1,1/2"x1,1/4"		9.90	2124233		
	2"x1/2"		11.30	2124234		
	2"x3/4"		12.00	2124235		
	2"x1"		9.37	2124236		
	2"x1,1/4"		11.98	2124237		
	290 C			<i>Korķis (AV)</i>		
	1/2"	10	0.72	2124239		
	3/4"	10	0.97	2124240		
	1"	10	1.26	2124241		
	1,1/4"	10	1.92	2124242		
	1,1/2"	10	2.31	2124243		
	300 C			<i>Korķis (IV)</i>		
	1/2"	10	1.11	2124245		
	3/4"	10	1.36	2124246		
	1"	10	1.59	2124247		
	1,1/4"	10	2.45	2124248		
	1,1/2"	10	3.10	2124249		
	270 C			<i>Uzmava</i>		
	1/2"	10	1.02	2124251		
	3/4"	10	1.36	2124252		
	1"	10	1.90	2124253		
	1,1/4"		2.94	2124254		
	1,1/2"		4.26	2124255		
	240 C			<i>Uzmava - pāreja</i>		
	3/4"x1/2"	10	1.66	2124257		
	1"x1/2"	10	2.19	2124258		
	1"x3/4"	10	2.01	2124259		
	1,1/4"x1/2"	10	4.12	2124260		
	1,1/4"x3/4"	10	3.78	2124261		
	1,1/4"x1"	10	3.54	2124262		
	1,1/2"x1/2"		9.17	2124263		
	1,1/2"x3/4"		8.06	2124264		
	1,1/2"x1"		4.50	2124265		
	280 C			<i>Nipelis</i>		
	1/2"	10	0.96	2124272		
	3/4"	10	1.29	2124273		
	1"	10	1.71	2124274		
	1,1/4"	10	2.88	2124275		
	1,1/2"	10	3.29	2124276		
	245 C			<i>Nipelis reducēts</i>		
	3/4"x1/2"	10	1.79	2124278		
	1"x1/2"	10	3.71	2124279		
	1"x3/4"	10	2.01	2124280		
	1,1/4"x1/2"	10	7.89	2124281		
	1,1/4"x3/4"	10	6.71	2124282		
1,1/4"x1"	10	3.29	2124283			
1,1/2"x3/4"		6.76	2124284			

Cinkoti čuguna veidgabali

		GAB.	EUR	VEIKALS
	245 C			<i>Nipelis reducēts</i>
	1,1/2"x1"		8.10	2124285
	1,1/2"x1,1/4"		3.99	2124286
	2"x1"		9.72	2124287
	2"x1,1/4"		8.77	2124288
	2"x1,1/2"		8.03	2124289
	241 C			<i>Vītņu pāreja (A-I)</i>
	1/2"x3/8"		0.80	2124290
	3/4"x1/2"	10	0.94	2124291
	1"x1/2"	10	1.32	2124292
	1"x3/4"	10	1.24	2124293
	1,1/4"x1/2"	10	2.28	2124294
	1,1/4"x3/4"	10	1.98	2124295
	1,1/4"x1"	10	1.57	2124296
	1,1/2"x1/2"	10	2.95	2124297
	1,1/2"x3/4"	10	3.17	2124298
	1,1/2"x1"	10	2.20	2124299
	1,1/2"x1,1/4"	10	2.35	2124300
	2"x1/2"	10	5.95	2124301
	2"x3/4"		5.89	2124302
	2"x1"		4.86	2124303
	2"x1,1/4"		4.53	2124304
	2"x1,1/2"		4.22	2124305
	529 C			<i>Pagarinātājs</i>
	1/2"	10	1.87	2124306
	3/4"	10	2.65	2124307
	1"	10	4.95	2124308
	246 C			<i>Vītņu pāreja</i>
	3/4"x1/2"	10	2.20	2124309
	1"x1/2"	10	3.51	2124310
	1"x3/4"	10	3.60	2124311
	1,1/4"x1/2"	10	9.93	2124312
	1,1/4"x3/4"	10	7.35	2124313
	1,1/4"x1"	10	4.28	2124314
	1,1/2"x3/4"		8.44	2124315
	1,1/2"x1"		7.99	2124316
	1,1/2"x1,1/4"		7.03	2124317
	2"x1"		13.88	2124318
	2"x1,1/4"		10.80	2124319
	2"x1,1/2"		11.30	2124320
	330 C			<i>Izjaucams savienojums (I-I)</i>
	1/2"	10	3.48	2124321
	3/4"	10	4.08	2124322
	1"	10	4.69	2124323
	1,1/4"		7.83	2124324
	1,1/2"		10.12	2124325
	2"		16.88	2124326
	331 C			<i>Izjaucams savienojums (I-A)</i>
	1/2"	10	4.42	2124327
	3/4"	10	4.97	2124328
	1"	10	5.94	2124329
	1,1/4"		10.53	2124330
	1,1/2"		12.74	2124331
	2"		19.93	2124332
	<i>Gumijas blīve izjaucamiem savienojumiem</i>			
	03576	1/2"	100	0.32 2166001
		3/4"	100	0.28 2166002
		1"	100	0.46 2166003
		1,1/2"	100	0.66 2166004
		1,1/4"	100	0.74 2166005
	2"	100	0.68 2166006	







		GAB.	EUR	VEIKALS
	340 C			<i>Izjaucams savienojums (konuss (I-I))</i>
	1/2"	10	4.39	2124333
	3/4"	10	4.97	2124334
	1"	10	5.74	2124335
	1,1/4"		9.83	2124336
	1,1/2"		11.49	2124337
	2"		18.66	2124338
	341 C			<i>Izjaucams savienojums (konuss (I-A))</i>
	1/2"	10	4.29	2124339
	3/4"	10	5.17	2124340
	1"	10	6.45	2124341
	1,1/4"		10.17	2124342
	1,1/2"		12.99	2124343
	2"		20.72	2124344
	180 C			<i>Krusts</i>
	1/2"	10	5.27	2124359
	3/4"	10	7.99	2124360
	1"		9.94	2124361
	1,1/4"		11.66	2124362
	1,1/2"		14.86	2124363
	2"		19.44	2124364
	310 C			<i>Kontruzgrieznis</i>
	1/2"		0.86	2124365
	3/4"		0.90	2124366
	1"		1.30	2124367
	1,1/4"		1.92	2124368
	1,1/2"		2.10	2124369
	2"		4.50	2124370
	291 M			<i>Korķis radiatoram kreisā vītne</i>
	1,1/4"x1/2"		1.50	2124407
	1,1/4"x3/4"		1.50	2124408
				<i>Korķis radiatoram labā vītne</i>
	1,1/4"x1/2"		1.50	2124410
	1,1/4"x3/4"		1.50	2124411
	291 M			<i>Korķis radiatoram labā vītne</i>
	1,1/4"		1.50	2124409
				<i>Korķis radiatoram kreisā vītne</i>
	1,1/4"		1.50	2124406







VEIKALS

VEIKALS

EUR









EUR

201		<i>Lūkums</i>	
	21.3*2.0	1.39	2132001
	26.9*2.6	1.83	2132002
	33.7*2.6	1.90	2132003
	42.4*2.6	2.62	2132004
	48.3*2.6	3.05	2132005
	57.0*2.9	4.44	2132006
	60.3*2.9	5.03	2132007
202		<i>Pāreja</i>	
	26.9-21.3	1.89	2132008
	33.7-21.3	2.52	2132009
	33.7-26.9	2.62	2132010
	42.4-21.3	3.80	2132011
	42.4-26.9	3.73	2132012
	42.4-33.7	2.89	2132013
	48.3-21.3	4.68	2132014
	48.3-26.9	4.35	2132015
	48.3-33.7	3.53	2132016
	48.3-42.4	4.29	2132017
	57.0-26.9	7.81	2132018
	57.0-33.7	7.48	2132019
	57.0-42.4	6.35	2132020
	57.0-48.3	3.75	2132021
	60.3-26.9	5.64	2132022
60.3-33.7	5.69	2132023	
60.3-42.4	4.79	2132024	
60.3-48.3	5.01	2132025	
203		<i>Korķis</i>	
	26.9*2.6	1.10	2132026
	33.7*2.6	1.60	2132027
	42.4*2.6	1.60	2132028
	48.3*2.6	2.37	2132029
	57.0*2.9	3.04	2132030
	60.3*2.9	2.88	2132031
204		<i>Trejšgabals</i>	
	21.3*2.0	7.23	2132032
	26.9*2.6	10.61	2132033
	33.7*2.6	12.22	2132034
	42.4*2.6	13.35	2132035
	48.3*2.6	14.64	2132036
	57.0*2.9	21.99	2132037
205		<i>Uzmava</i>	
	1/2"	0.65	2132038
	3/4"	0.91	2132039
	1"	1.14	2132040
	1 1/4"	1.56	2132041
	1 1/2"	1.84	2132042
	2"	2.53	2132043
206		<i>Pāreja uz vītņi</i>	
	1/2"x40	0.56	2132044
	3/4"x50	0.67	2132045
	1"x60	0.91	2132046
	1 1/4"x60	1.26	2132047
	1 1/2"x60	1.73	2132048
	2"x60	2.17	2132049

312 C		<i>Īsā vītne (cinkota)</i>	
	1/2"x40	1.11	2124386
	1/2"x60	0.88	2124424
	1/2"x100	1.45	2124387
	1/2"x150	2.17	2124388
	3/4"x50	1.19	2124389
	3/4"x100	2.21	2124390
	3/4"x150	2.73	2124391
	1"x60	1.75	2124413
	1"x100	2.90	2124392
	1"x150	4.24	2124393
	1,1/4"x70	2.06	2124400
	1,1/2"x70	3.05	2124401
2"x70	3.69	2124402	
312 M		<i>Īsā vītne (melna)</i>	
	1/2"x40	0.60	2124374
	1/2"x60	0.67	2124423
	1/2"x100	1.41	2124375
	1/2"x150	1.71	2124376
	3/4"x50	0.72	2124377
	3/4"x100	1.76	2124378
	3/4"x150	2.75	2124379
	1"x60	0.93	2124380
	1"x100	2.81	2124381
	1"x150	4.23	2124382
	1,1/4"x70	1.87	2124394
	1,1/2"x70	2.12	2124395
2"x70	3.29	2124396	
311 C		<i>Garā vītne (cinkota)</i>	
	1/2"x100	1.60	2124383
	3/4"x110	2.19	2124384
	1"x120	2.79	2124385
	1,1/4"x130	4.38	2124403
	1,1/2"x140	5.63	2124404
	2"x150	7.83	2124405
311 M		<i>Garā vītne (melna)</i>	
	1/2"x100	1.31	2124371
	3/4"x110	1.60	2124372
	1"x120	2.51	2124373
	1,1/4"x130	3.48	2124397
	1,1/2"x140	4.09	2124398
	2"x150	7.52	2124399
GARUMS 3 M		<i>Tērauda caurule, melna</i>	
	DN15(21.3x2.6)	5.24	2532008
	DN20(26.9x2.6)	6.24	2532009
	DN25(33.7x3.2)	11.00	2532010
	DN32(42.3x3.2)	13.61	2532020
	DN40(48.3x3.2)	15.74	2532012
	DN50(60.3x3.2)	19.66	2532013
	DN65(76.1x3.2)	22.71	2532023
GARUMS 3 M		<i>Tērauda caurule, cinkota</i>	
	DN15(21.3x2.6)	5.73	2532025
	DN20(26.9x2.6)	8.21	2532016
	DN25(33.7x3.2)	11.49	2532014
	DN32(42.3x3.2)	13.95	2532015
	DN40(48.3x3.2)	16.86	2532021
	DN50(60.3x3.2)	21.62	2532022







VEIKALS













GAB. EUR















	900 PPR caurule PN 20			
	4	0.55	16x2,7	3936092
	4	1.22	20x3,4	3936093
	4	1.81	25x4,2	3936094
	4	3.21	32x5,4	3936095
	4	5.02	40x6,7	3936145
	4	8.13	50x8,4	3936146
	918 PPR ar alumīnija slāni caurule PN20			
	4	1.95	20x3,4	3936142
	4	2.75	25x4,2	3936143
	4	4.16	32x5,4	3936144
	4	6.32	40x6,7	3936168
	4	9.52	50x8,4	3936169
	4	15.21	63x10,5	3936170
	919 PPR caurule PN 20 ar šķiedru			
	4	1.20	20x2,8	3936161
	4	1.90	25x3,5	3936162
	4	3.25	32x4,4	3936163
	4	4.62	40x5,5	3936164
	4	6.61	50x6,9	3936165
	901 PPR līkums 45° I-I			
		0.22	dn 16	3936005
	50	0.19	dn 20	3936006
	40	0.24	dn 25	3936007
	20	0.44	dn 32	3936008
		0.77	dn 40	3936106
		1.42	dn 50	3936107
	3.00	dn 63	3936108	
	901 PPR līkums 90° I-I			
	50	0.19	dn 20	3936010
	40	0.31	dn 25	3936011
	20	0.42	dn 32	3936012
	10	0.82	dn 40	3936109
	5	1.55	dn 50	3936110
	901 PPR līkums 45° I-A			
		0.31	dn 16	3936013
	200	0.62	dn 20	3936014
	50	0.65	dn 25	3936015
	10	0.96	dn 32	3936016
	901 PPR līkums 90° I-A			
		0.23	dn 16	3936017
	100	0.31	dn 20	3936018
		0.46	dn 25	3936019
		0.80	dn 32	3936020
	907 PPR līkums 90° IV			
	10	1.86	16x1/2i	3936053
	20	1.38	20x1/2i	3936054
	10	1.90	20x3/4i	3936055
	10	1.60	25x1/2i	3936056
	50	1.79	25x3/4i	3936057
	5	2.69	32x3/4i	3936058
	907 PPR līkums 90° AV			
	10	2.00	16x1/2ā	3936060
	10	1.46	20x1/2ā	3936061
	10	2.17	20x3/4ā	3936062
	10	1.81	25x1/2ā	3936063
	10	2.20	25x3/4ā	3936064
		4.14	32x3/4ā	3936065
	6.59	32x1"ā	3936066	

VEIKALS

GAB. EUR

	911 PPR pāreja IV				
	50	1.46	16x1/2i	3936043	
	20	1.23	20x1/2i	3936044	
	20	1.90	20x3/4i	3936045	
	20	1.27	25x1/2i	3936046	
	20	1.52	25x3/4i	3936047	
	20	1.71	32x1/2i	3936148	
	10	2.21	32x3/4i	3936158	
	10	3.53	32x1i	3936104	
	5	6.39	40x1,1/4i	3936136	
		8.19	50x1,1/2i	3936137	
	12.04	63x2i	3936138		
	911 PPR pāreja AV				
	20	1.38	20x1/2ā	3936049	
		2.09	20x3/4ā	3936050	
	20	1.66	25x1/2ā	3936051	
	10	2.02	25x3/4ā	3936052	
	10	2.49	32x3/4"	3936157	
	5	3.93	32x1ā	3936105	
	5	8.28	40x1,1/4ā	3936139	
		12.68	50x1,1/2ā	3936140	
	4	17.07	63x2ā	3936141	
		904 PPR trejgabals			
20		0.19	dn 16	3936021	
40		0.22	dn 20	3936022	
20		0.37	dn 25	3936023	
10		0.54	dn 32	3936024	
5		1.13	dn 40	3936112	
		2.01	dn 50	3936113	
	904 PPR trejgabals				
		0.54	25/16/25	3936026	
		0.32	25/20/25	3936027	
	30	0.51	32/20/32	3936028	
	20	0.60	32/25/32	3936029	
	25	0.98	40/20/40	3936115	
		0.98	40/25/40	3936116	
	10	1.03	40/32/40	3936117	
	10	2.48	50/20/50	3936118	
		2.42	50/25/50	3936119	
		2.47	50/32/50	3936120	
	5	2.42	50/40/50	3936121	
		4.22	63/25/63	3936181	
		4.22	63/32/63	3936180	
		4.12	63/40/63	3936149	
		4.21	63/50/63	3936151	
		905 PPR trejgabals AV			
			2.19	16x1/2āx16	3936067
10		1.60	20x1/2āx20	3936068	
		2.06	20x3/4āx20	3936069	
		1.68	25x1/2āx25	3936070	
10		2.03	25x3/4āx25	3936071	
		2.64	32x1/2"x32	3936185	
	3.14	32x3/4āx32	3936072		
	4.59	32x1"āx32	3936073		
	905 PPR trejgabals IV				
	10	1.29	20x1/2ix20	3936075	
	10	1.57	20x3/4ix20	3936076	
	10	1.39	25x1/2ix25	3936077	
	10	1.83	25x3/4ix25	3936078	
		2.23	32x1/2"x32	3936184	
		2.68	32x3/4ix32	3936079	
		5.67	32x1"ix32	3936080	

		VEIKALS			
		GAB.	EUR		
	908	<i>PPR mufe</i>			
	100	0.15	dn 20	3936031	
	50	0.19	dn 25	3936032	
	30	0.29	dn 32	3936033	
	10	0.51	dn 40	3936122	
	10	1.03	dn 50	3936123	
	9	1.77	dn 63	3936124	
	903	<i>PPR mufe ar pāreju</i>			
		0.50	16/25	3936035	
		0.16	20/25	3936036	
	50	0.22	20/32	3936037	
	20	0.32	25/32	3936038	
	40	0.31	20/40	3936125	
	20	0.32	25/40	3936126	
		0.48	32/40	3936127	
		0.98	20/50	3936150	
		0.81	32/50	3936128	
		1.24	40/50	3936129	
		0.92	32/63	3936130	
	10	1.16	40/63	3936131	
	5	1.30	50/63	3936132	
	912	<i>PPR uzdeva ar pāreju IV</i>			
	400	0.22	25/20	3936336	
	200	0.31	32/20	3936337	
	200	0.28	32/25	3936338	
	910	<i>PPR korķis</i>			
	100	0.12	dn 20	3936040	
		0.14	dn 25	3936041	
	10	0.23	dn 32	3936042	
		0.41	dn 40	3936133	
		1.20	dn 50	3936134	
		1.60	dn 63	3936135	
	920	<i>PPR korķis iekšējais</i>			
		0.34	dn 32	3936195	
	906	<i>PPR apeja</i>			
		0.31	dn 16	3936001	
		0.70	dn 20	3936002	
		0.98	dn 25	3936003	
		1.52	dn 32	3936004	
	902	<i>PPR līkums ar sienas stiprinājumu IV</i>			
	10	1.41	20x1/2i	3936082	
		2.59	20x3/4i	3936083	
	10	1.63	25x1/2i	3936084	
		2.59	25x3/4i	3936085	
	902	<i>PPR līkums ar sienas stiprinājumu AV</i>			
		1.78	20x1/2ā	3936087	
		2.96	25x1/2ā	3936089	
	10	3.27	25x3/4ā	3936090	
	914	<i>PPR kompensācijas cilpa</i>			
		2.03	dn 16	3936096	
		2.27	dn 20	3936097	
	915	<i>PPR izjaucama uzdeva IV</i>			
	20	2.74	20x1/2	3936100	
		3.52	25x3/4	3936101	
		6.89	32x1"	3936186	
	916	<i>PPR izjaucama uzdeva AV</i>			
		4.78	20x1/2	3936102	
		5.10	25x3/4	3936103	
		7.06	32x1"	3936187	
	922	<i>PPR pāreja ar saskrūvi IV</i>			
		2.21	20x1/2"	3936178	
		3.03	25x3/4"	3936182	
		6.80	32x1"	3936301	









		VEIKALS			
		GAB.	EUR		
	923	<i>PPR pāreja līkums ar saskrūvi IV</i>			
		1.93	20x1/2"	3936177	
		2.87	25x3/4"	3936183	
	921	<i>PPR saskrūve plastmasa IV</i>			
	200	1.53	dn 20	3936342	
	100	1.94	dn 25	3936343	
	60	2.36	dn 32	3936344	
	924	<i>PPR apeja īsā</i>			
		0.47	dn 20	3936152	
		0.47	dn 25	3936153	
		0.92	dn 32	3936154	
	925	<i>PPR zemapmetuma līkums I-V</i>			
		3.47	20x1/2"	3936091	
	909	<i>PPR sienas montāžas komplekts</i>			
		6.34	20x1/2"	3936167	
	4476 A/10	<i>Montāžas plāksne ar 2 PPR līkumiem</i>			
	10	9.78	1/2"x20	3936329	
	928	<i>Gružu filtrs PPR</i>			
	100	2.08	1/2"	3936339	
	80	2.92	3/4"	3936340	
	35	5.28	1"	3936341	
	927	<i>PPR lodveida ventilis ar saskrūvi</i>			
	10	13.54	25x3/4"	3936333	
	917	<i>PPR lodveida ventilis (zemapmetuma)</i>			
	10	3.25	dn 20	3936323	
	5	4.65	dn 25	3936324	
	5	7.27	dn 32	3936325	
		13.92	dn 40	3936326	
		21.88	dn 50	3936327	
	1	38.90	dn 63	3936328	
	921 PPR	<i>Šķēres PPR caurulēm 0-42mm nerūsējoša tērauda asmenis</i>			
		14.73		3435001	
		14.46		3435002	
	913- PLAKANS	<i>Lodāmurs 1000W (komplektā ar uzgaļiem 20-63)</i>			
		69.91	1000W	7635001	
		55.08	800W	7635018	
	913-apalš	<i>Lodāmurs (komplektā ar uzgaļiem 16-32)</i>			
		78.45	1200W	7635014	
		73.61	800W	7635020	
	912-uzg. apalš	<i>Lodāmura PPR uzgali</i>			
		8.24	20	9735006	
		9.00	25	9735007	
		9.81	32	9735008	
	912-uzg. plakans	<i>Lodāmura PPR uzgali</i>			
		12.36	16	9735001	
		9.59	20	9735002	
		10.68	25	9735003	
		13.31	32	9735004	
		4.41	40	7635007	
		5.39	50	7635008	
		6.37	63	7635009	









VEIKALS

VEIKALS

EUR

EUR























1509068		<i>Likums 45° I-I</i>	
	15x15	2.31	2215070
	18x18	2.41	2215007
	22x22	2.50	2215008
	28x28	3.40	2215009
1509068		<i>Likums 45° I-A</i>	
	15x15	2.17	2215010
	18x18	2.26	2215011
	22x22	2.40	2215012
	28x28	3.54	2215013
1509068		<i>Likums 90° I-I</i>	
	15x15	1.92	2215014
	18x18	2.07	2215015
	22x22	2.38	2215016
	28x28	3.25	2215017
1509068		<i>Likums 90° I-A</i>	
	15x15	2.02	2215018
	18x18	2.25	2215019
	22x22	2.60	2215020
	28x28	3.22	2215071
1509045		<i>Pāreja AV</i>	
	15x1/2"	3.36	2215021
	18x1/2"	3.93	2215023
	18x3/4"	4.28	2215024
	22x1/2"	4.09	2215025
	22x3/4"	4.61	2215072
	28x1/2"	5.43	2215026
	28x3/4"	5.61	2215027
	28x1"	5.77	2215028
1509044		<i>Pāreja IV</i>	
	15x1/2"	2.57	2215073
	18x1/2"	3.06	2215033
	18x3/4"	4.93	2215034
	22x1/2"	3.92	2215035
	22x3/4"	4.60	2215074
	28x1/2"	5.78	2215037
	28x3/4"	4.60	2215038
	28x1"	5.94	2215036
1509057		<i>Krusts</i>	
	15x15	9.16	2215029
	18x15	9.62	2215079
	18x18	9.62	2215030
	22x15	10.55	2215080
	22x18	10.55	2215081
	22x22	10.54	2215031
	28x28	10.88	2215032
1509022		<i>Apeja</i>	
	15	3.72	2215082
	18	3.78	2215083
	22	4.36	2215084

1509245		<i>Savienojums I-I</i>	
	15x15	1.42	2215039
	18x18	1.47	2215040
	22x22	1.70	2215041
	28x28	1.99	2215042
1509221		<i>Savienojums reducēts I-A</i>	
	18x15	1.32	2215043
	22x15	1.32	2215044
	22x18	1.43	2215045
	28x18	2.16	2215046
	28x22	1.84	2215047
1509080		<i>Remontuzmava</i>	
	15x15	1.59	2215075
	18x18	1.84	2215076
	22x22	2.13	2215077
	28x28	2.70	2215048
1509042		<i>Uzmava ar pāreju I-I</i>	
	18x15	2.33	2215085
	22x15	2.37	2215086
	22x18	2.59	2215087
	28x15	4.03	2215088
	28x18	3.85	2215089
	28x22	3.39	2215090
1509257		<i>Trejšgabals</i>	
	15	3.86	2215078
	18	4.14	2215049
	22	4.47	2215050
	28	5.96	2215051
1509258		<i>Trejšgabals IV</i>	
	15x1/2"	5.50	2215052
	18x1/2"	5.66	2215053
	22x1/2"	6.22	2215054
	22x3/4"	6.51	2215055
	28x1/2"	7.25	2215057
	28x3/4"	8.66	2215058
	28x1"	10.08	2215056
1509260		<i>Trejšgabals ar pāreju</i>	
	15x22x15	4.63	2215059
	18x15x18	4.14	2215060
	18x22x18	4.15	2215061
	22x15x22	4.40	2215062
	22x18x22	4.47	2215063
	28x15x28	5.92	2215064
	28x18x28	6.12	2215065
	28x22x28	6.43	2215066
1509250		<i>Korķis</i>	
	15	2.66	2215067
	18	2.81	2215068
	22	3.01	2215069
	28	4.46	2215006
1530207		<i>Karbona caurule</i>	
	15	2.00	2215000
	18	2.39	2215001
	22	3.19	2215002
	28	4.15	2215003
	35	5.92	2215004
	42	7.53	2215005

PLASTMASAS VEIDGABALI POLIETILĒNA CAURULEI

GAB.	EUR	VEIKALS	
510 <i>Uzmava</i>			
	20x20 20	2.18	9018001
	25x25 10	2.58	9018002
	32x32 10	3.36	9018003
	40x40 5	5.45	9018004
	50x50 5	7.44	9018005
	63x63 5	10.28	9018006
511 <i>Pāreja (ārējā vītne - caurule)</i>			
	20x1/2" 20	1.21	9018007
	20x3/4" 20	1.21	9018008
	25x1/2" 10	1.43	9018009
	25x3/4" 10	1.43	9018010
	25x1" 10	1.43	9018011
	32x3/4" 10	1.82	9018012
	32x1" 10	1.82	9018013
	32x1,1/4" 10	2.04	9018014
	40x1" 5	3.40	9018015
	40x1,1/4" 5	3.40	9018016
	40x1,1/2" 5	3.40	9018017
	50x1,1/2" 5	4.43	9018018
	63x2" 5	6.28	9018019
512 <i>Uzmava ar pāreju</i>			
	25x20 20	2.36	9018020
	32x25 10	3.07	9018021
	40x32 5	5.44	9018022
	50x40 5	6.85	9018023
	63x40 5	9.68	9018024
	63x50 5	9.69	9018025
513 <i>Līkums 90°</i>			
	20x20 20	2.19	9018026
	25x25 10	2.62	9018027
	32x32 10	3.25	9018028
	40x40 5	5.69	9018029
	50x50 5	7.97	9018030
	63x63 5	10.10	9018031
514 <i>Trejgabals</i>			
	20x20x20 20	2.84	9018032
	25x25x25 10	3.71	9018033
	32x32x32 10	4.89	9018034
	40x40x40 5	7.97	9018035
	50x50x50 5	10.86	9018036
	63x63x63 5	15.45	9018037
515 <i>Trejgabals ar iekšējo vītņi</i>			
	20x1/2"x20 20	2.41	9018038
	25x1/2"x25 10	3.11	9018039
	25x3/4"x25 10	3.11	9018040
	32x3/4"x32 10	4.16	9018041
	32x1"x32 10	4.16	9018042
	40x1"x40 5	8.40	9018043
	40x1,1/4"x40 5	8.40	9018044
	50x1,1/2"x50 5	10.70	9018045
	63x2"x63 5	13.43	9018046
521 <i>Korkis</i>			
	20 20	1.44	9018060
	25 10	1.66	9018061
	32 10	1.96	9018062
	40 5	3.34	9018063
	50 5	4.95	9018064
	63 5	6.70	9018065
505 <i>Uzmavas atzars</i>			
	20x1/2" 20	2.00	9018086
	25x1/2" 20	2.05	9018087
	25x3/4" 20	2.05	9018088
	32x3/4" 20	3.01	9018089
	32x1" 20	2.36	9018090
518 <i>Līkums 90° ar iekšējo vītņi</i>			
	20x1/2" 20	1.80	9018047
	25x3/4" 10	2.29	9018048
	32x3/4" 10	2.68	9018049
	32x1" 10	2.68	9018050
	40x1,1/4" 5	5.47	9018051
	50x1,1/2" 5	7.26	9018052
	63x2" 5	9.66	9018053
519 <i>Līkums 90° ar ārējo vītņi</i>			
	20x1/2" 20	1.58	9018054
	25x1/2" 20	1.52	9018092
	25x3/4" 10	1.91	9018055
	32x1" 10	2.41	9018056
	40x1,1/4" 5	4.08	9018057
	50x1,1/2" 5	5.85	9018058
	63x2" 5	8.09	9018059
523 <i>Trejgabals ar pāreju</i>			
	25x20 10	4.44	9018066
	32x25 10	5.01	9018067
	40x32 1	10.55	9018068
	50x40 1	14.18	9018069
	63x50 1	19.11	9018070
601 <i>Pāreja (iekšējā vītne - caurule)</i>			
	20x1/2" 20	1.49	9018071
	25x1/2" 10	1.65	9018083
	25x3/4" 10	1.65	9018072
	25x1" 10	1.65	9018084
	32x3/4" 10	2.12	9018085
	32x1" 10	2.12	9018073
	40x1,1/4" 5	3.13	9018074
	50x1,1/2" 5	4.53	9018075
	63x2" 5	6.36	9018076
335 <i>Lodveida ventilis PVC</i>			
	DN20	12.00	9018093
	DN25	12.00	9018094
	DN32	14.29	9018095
GHI10 <i>Uzgrieznis</i>			
	20	0.52	9018077
	25	0.77	9018078
	32	0.93	9018079
	40	1.59	9018080
	50	2.03	9018081
	63	2.87	9018082
ARG10 <i>Ieliktnis</i>			
	20	0.40	9066001
	25	0.48	9066002
	32	0.88	9066003
	40	1.01	9066004
	50	1.26	9066005
	63	2.29	9066006
GUA11 <i>Bļīve</i>			
	Dn20	0.42	9066007
	Dn25	0.45	9066008
	Dn32	0.65	9066009
	Dn40	0.80	9066010
	Dn50	0.87	9066011
	Dn63	1.04	9066012
Polietilēna caurule rullī			
	20x2,0; 100 m	1.04	2518001
	20x2,0; 500 m	0.94	2518012
	25x2,3; 100 m	1.33	2518002
	25x2,3; 500 m	1.33	2518013
	32x3,0; 100 m	1.57	2518003
	32x3,0; 500 m	1.57	2518014
	40x3,0; 100 m	2.30	4218001
	40x3,7; 100 m	2.89	2518005
	50x3,0; 100 m	2.69	4218003
	50x4,6; 100 m	4.33	2518004
	63x3,8; 100 m	4.90	2518006















RADIATORU VENTIĻI VENTIĻI DVIELU ŽĀVĒTĀJIEM













GAB. EUR VEIKALS					GAB. EUR VEIKALS								
KAS0401303	<i>Radiatora ventilis, leņķa</i>		1/2"	1	4.29	3920001	3760	<i>Ventīlis, leņķa, rokas regulācija</i>		1/2"	1	19.36	2120021
KAS0405310	<i>Radiatora ventilis, leņķa</i>		3/4"	1	2.67	3920002	3761	<i>Ventīlis, leņķa, labais</i>		1/2"	1	28.05	2120022
KAS042301	<i>Radiatora ventilis, taisns</i>		1/2"	1	4.83	3920003	3762	<i>Ventīlis, leņķa, kreisais</i>		1/2"	1	26.57	2120023
KAS0402303	<i>Atpakaļgaitas ventilis, taisnais</i>		1/2"	1	5.48	3920005	3763	<i>Ventīlis, leņķa</i>		1/2"	1	11.78	2120024
KAS0404305	<i>Atpakaļgaitas ventilis, leņķa</i>		1/2"	1	4.83	3920004	3764	<i>Ventīlis, leņķa ar slēptu pievadu</i>		1/2"	1	11.29	2120025
KAS8102005	<i>Termo galva, hromēta</i>		1/2"	1	7.41	3920006	3770	<i>Termogalva</i>		1/2"	1	25.56	2120026
KAS8102004	<i>Termo galva, balta</i>		1/2"	1	7.04	3920007	3765	<i>Ventīlis, leņķa, termo</i>		1/2"	1	21.51	2120027
KAS1314014	<i>Termoventīlis, leņķa, PEX Bez galvas</i>		1/2"	1	2.72	3920008	3766	<i>Ventīlis, leņķa, labais, termo</i>		1/2"	1	30.88	2120028
KAS1309007	<i>Termoventīlis, aksiālais ar galvu</i>		1/2"	1	13.47	3920010	3767	<i>Ventīlis, leņķa, kreisais, termo</i>		1/2"	1	30.88	2120029
KAS1304010	<i>Termoventīlis, taisnais Ar galvu</i>		1/2"	1	12.70	3920030	3772	<i>Pāreja daudzslāņu caurulei komplekts</i>		16x1/2"	1	12.01	0925169
KAS1302305	<i>Radiatoru ventiļu komplekts termostats</i>		1/2"		16.66	3920032	3774	<i>Pāreja misiņa caurulei komplekts</i>		15 x 1/2"	1	9.81	0925168
							3789	<i>Pievads divieļu žāvētājam 15 cm</i>		1/2"x15	1	5.65	2110003

		GAB.	EUR	VEIKALS
	7750	<i>Lodveida ventilis (I-I)</i>		
	3/8"	25	6.15	0620141
	1/2"	25	5.39	0620001
	3/4"	20	7.40	0620002
	1"	10	11.09	0620003
	1,1/4"		19.92	0620048
	1,1/2"		30.68	0620049
2"		48.94	0620050	
	7752	<i>Lodveida ventilis (I-I)</i>		
	3/8"	25	6.12	0620130
	1/2"	25	5.39	0620004
	3/4"	20	7.36	0620005
1"	10	11.19	0620051	
	7951	<i>Lodveida ventilis (I-I)</i>		
	4"		111.50	0620102
	7605	<i>Lodveida ventilis (I-A)</i>		
	1/2"	20	6.23	0620026
	3/4"	15	9.01	0620027
	1"	10	13.54	0620028
	1,1/4"		21.12	0620052
	1,1/2"		31.65	0620053
2"		46.73	0620054	
	7607	<i>Lodveida ventilis (I-A)</i>		
	3/8"	25	6.34	0620010
	1/2"	20	6.26	0620029
	3/4"	15	8.94	0620030
1"	10	13.52	0620055	
	7645	<i>Lodveida ventilis (A-A)</i>		
	1/2"	20	6.42	0620006
	3/4"	15	9.48	0620007
	1"	10	13.92	0620056
	1,1/4"		22.70	0620057
	1,1/2"		33.85	0620058
2"		55.86	0620059	
	7647	<i>Lodveida ventilis (A-A)</i>		
	1/2"	20	6.42	0620008
	3/4"	15	9.45	0620009
1"	10	14.02	0620060	
	<i>Lodveida krāns ar pieslēguzgriezni</i>			
	7650			
	1/2"	15	9.04	0620038
	3/4"	10	13.43	0620039
	1"	6	19.06	0620040
1,1/4"	5	30.91	0620041	
	7950	<i>Lodveida ventilis gāzei (I-I)</i>		
	1/2"	15	8.91	0620135
	7952	<i>Lodveida ventilis gāzei (I-I)</i>		
	1/2"	15	9.03	0620134















		GAB.	EUR	VEIKALS
	7955	<i>Lodveida ventilis gāzei (I-A)</i>		
	1/2"	15	8.38	0620132
	7957	<i>Lodveida ventilis gāzei (I-A)</i>		
	1/2"	15	8.69	0620133
	7956	<i>Lodveida ventilis</i>		
	Ø15	15	4.25	0620106
	Ø22	10	5.45	0620107
Ø28	8	9.70	0620108	
	7759	<i>Sistēmas uzpildes ventilis</i>		
	1/2"		8.93	0620109
	<i>Lodveida ventilis ar atgaisotāju</i>			
	7615	1/2"	10	9.83
		3/4"	10	4.60
		1,1/4"		9.75
		1,1/2"		13.40
2"			17.00	
	7620	<i>Lodveida trīscēļu ventilis</i>		
	1/2"		15.20	0620032
	3/4"		18.80	0620033
	1,1/4"		37.60	0620035
	1,1/2"		67.20	0620036
2"		102.00	0620037	
	7300	<i>Dārza krāns</i>		
	1/2"	12	7.49	0620021
	3/4"	10	10.37	0620022
	1"	6	17.13	0620023
	7350	<i>Dārza krāns</i>		
	1/2"	20	7.48	0620024
	3/4"	10	10.39	0620025
	1"	6	18.91	0620061
	7700	<i>Mini ventilis</i>		
	1/2"	20	4.98	0620011
	7720	<i>Mini ventilis</i>		
	1/2"	25	4.92	0620012
	5230	<i>Aizbīdnis</i>		
	1/2"	20	7.75	0620062
	3/4"	20	8.73	0620063
	1"	20	12.63	0620064
	1,1/4"	10	19.54	0620119
	1,1/2"	10	25.08	0620120
	2"		37.87	0620121
	2,1/2"		18.20	0620122
3"		24.30	0620123	
	<i>Lodveida ventilis iebūvei sienā</i>			
	8002			
	1/2"	8	17.54	0620065
	3/4"		20.46	0620066

Noslēgarmatūra

		GAB.	EUR	VEIKALS
	1772891	<i>Termostata ventilis aksiālais</i> HERTZ TS-90		
		1/2"	15.01	6320005
	3613	<i>Termostata galva</i>	60	13.76 0620086
	3602	<i>Radiatoru ventilis taisnais</i>	1/2"	15 7.53 0620080
	3601	<i>Radiatoru ventilis leņķa</i>	1/2"	15 6.43 0620078
	3604	<i>Balansa ventilis taisnais</i>	1/2"	15 7.36 0620081
	3603	<i>Balansa ventilis leņķa</i>	1/2"	15 6.35 0620079
	3630	<i>Drošības vārsts</i>	1/2" 3 bar	7.35 0620087
			3/4" 3 bar	20.75 0620088
	3631		1/2" 6 bar	7.81 0620143
			3/4" 6 bar	12.58 0620144
	4005	<i>Drošības grupa ar manometru</i>	6 bar	50.33 1720007
	4000	<i>Drošības grupa ar manometru</i>	3 bar	45.56 1720006
	4021	<i>Atgaisotais automātiskais taisnais</i>		6.91 1720004
	0200.293	<i>Atgaisotais automātiskais, leņķa</i>		6.89 1720005
	3620	<i>Atgaisotais automātiskais taisnais</i>	1/2"	16 7.33 0620082
	7009C	<i>Atgaisotais automatiskais leņķa</i>	1/2"	10 12.24 0920002
	3621	<i>Atgaisotāja pretvārsts</i>	1/2"	0.59 0620092

		GAB.	EUR	VEIKALS
	9003	<i>Atgaisotājs mehāniskais</i>	1/2"	1.94 7420004
	9825 O	<i>Atgaisotājs mehāniskais</i>	1/2"	25 1.29 1720002
	9825 balts	<i>Korķis ar blīvi hromēts</i>	1/2"	25 0.95 7420005
	9825 Z	<i>Korķis ar blīvi hromēts</i>	1/2"	25 1.11 1720003
	9824 met	<i>Atslēga radiatora atgaisošanai (metāla)</i>		1.09 1735011
	9824PL	<i>Atslēga radiatora atg. (plastmasa)</i>		0.35 1735006
	2500	<i>Gružu filtrs</i>	1/2"	150 5.80 0620093
			3/4"	150 8.10 0620070
			1"	50 12.05 0620071
			1,1/4"	50 22.43 0620072
			1,1/2"	35 27.08 0620073
			2"	35 43.42 0620074
			1/2"	18 3.71 2120033
	1010	<i>Pretvārsts bez sieta</i>	1/2"	25 5.71 0620014
			3/4"	20 7.41 0620015
			1"	12 10.08 0620016
			1,1/4"	5 14.25 0620075
			1,1/2"	5 18.50 0620076
			2"	3 27.84 0620077
			2,1/2"	18.20 0620116
			3"	25.50 0620117
			4"	38.90 0620118
	1011	<i>Pretvārsts bez sieta (misīņa disks)</i>	1/2"	10 7.87 0620031
			3/4"	8 10.70 0620137
			1"	6 14.62 0620138
	1030	<i>Pretvārsts ar sietu</i>	1/2"	25 5.88 0620017
			3/4"	15 6.50 0620018
			1"	12 8.18 0620019
			1,1/4"	6 11.94 0620125
			1,1/2"	4 15.29 0620126
			2"	2 21.24 0620127
	1920	<i>Siets pretvārstam</i>	1/2"	1.45 0620067
			3/4"	1.51 0620068
			1"	1.80 0620069
			1,1/4"	2.58 2320108
			1,1/2"	3.97 2320106
			2"	4.59 2320107
	7000	<i>Pretvārsts ar klapī</i>	1/2"	7.82 0620110
			3/4"	10.82 0620111
			1"	14.25 0620112
			1,1/4"	20.11 0620113
			1,1/2"	26.65 0620114
			2"	40.45 0620115

		GAB.	EUR	VEIKALS			GAB.	EUR	VEIKALS
	359 1/2"x3/4"x1/2"	10	8.64	2020008	<i>Trīsceļu krāns</i>			<i>Stūra ventīlis</i>	
							FS-01 1/2"x1/2"	SARKANS	5.12 4920008
								ZILS	5.12 4920009
							FS-02 1/2"x3/4"		5.24 4920010
	678 3/4"	5	13.51	0120001	<i>Krāns ar pagarinošo daļu</i>			<i>Stūra ventīlis</i>	
							FS-03 1/2"x1/2"	SARKANS	4.72 4920011
								ZILS	4.72 4920012
							FS-04 1/2"x3/4"		4.86 4920013
	2242/A 1/2"x3/4"	15	6.52	2020005	<i>Krāns veļas mašīnai</i>			<i>Stūra ventīlis</i>	
							FS-05		
							1/2"x3/8"x10	SARKANS	5.69 4920014
							1/2"x3/8"x10	ZILS	5.69 4920015
	7830 1/2"x3/4"		7.06	0620013	<i>Krāns veļas mašīnai</i>			<i>Stūra ventīlis</i>	
							FS-06		
							1/2"x3/8"x10	SARKANS	5.30 4920016
							1/2"x3/8"x10	ZILS	5.30 4920017
	244-030-00 1/2"x3/8"		6.89	0720003	<i>Stūra ventīlis</i>			<i>Krāns veļas mašīnai</i>	
							682		
							1/2"x3/4"		7.99 0120024
	7671/IB 1/2"x1/2"		5.35	0620139	<i>Stūra lodveida ventīlis</i>			<i>Stūra krāns veļas mašīnai</i>	
							950/D		
							1/2"x3/8"x3/4"		11.75 2020009
	950/C 1/2"x1/2"	20	6.42	2020004	<i>Stūra lodveida ventīlis ar filtru</i>			<i>Misiņa krāns vienam ūdenim</i>	
							968		
							1/2"		12.02 0601001
	130400 1/2"x1/2"x3/4"	10	4.43	7420001	<i>Krāns veļas mašīnai</i>			<i>Drošības vārsts boilerim</i>	
							1/2"		4.65 0620091
							3/4"		10.21 0620085
	694 1/2"x1/2"	2	5.82	0120006	<i>Stūra ventīlis</i>			<i>Drošības vārsts boilerim ar rokturi</i>	
							1/2"		5.57 0620083
							3/4"		11.46 0620084
	4080 1/2"x3/4"		5.35	0620020	<i>Krāns veļas mašīnai</i>			<i>Dekoratīvs noslēgs izlietnei hromēts</i>	
							700		
							ø43mm	25	6.83 1245004
	700/10				<i>Dekoratīvs noslēgs izlietnei balts</i>				
							ø43mm	10	7.98 1245019

		GAB. EUR VEIKALS						GAB. EUR VEIKALS			
SLD1001		<i>Lodveida ventīlis (I-I)</i>				SLD204		<i>Dārza krāns ar tvertnes vāciņu</i>			
	1/2"	24/120	3.13	9620003		1/2"	6.04	9620009			
	3/4"	18/90	4.92	9620018		3/4"	6.53	9620010			
	1"	10/50	6.71	9620019		1"	7.19	9620012			
	1,1/4"	8/32	10.69	9620020							
	1,1/2"	6/24	16.88	9620021							
	2"	4/12	22.47	9620022							
SLD1002		<i>Lodveida ventīlis (I-I)</i>				1010 F		<i>Pretvārsts bez sieta</i>			
	1/2"	35/175	3.12	9620007		1/2"	30	4.30	2120001		
	3/4"	18/90	4.91	9620034		3/4"	15	5.69	2120002		
	1"	10/50	6.56	9620035		1"	12	8.03	2120003		
SLD1003		<i>Lodveida ventīlis (I-Ā)</i>				1011 F		<i>Pretvārsts bez sieta (misiņa disks)</i>			
	1/2"	24/120	3.69	9620008		1/2"		5.58	2120013		
	3/4"	18/90	4.63	9620032		3/4"		7.91	2120014		
	1"	10/50	9.06	9620033		1"		11.02	2120015		
	1,1/4"	8/32	10.36	9620015		1,1/4"		17.31	2120016		
	1,1/2"	6/24	20.88	9620016		1,1/2"		22.42	2120017		
	2"	3/12	31.71	9620017		2"		34.45	2120018		
SLD1004		<i>Lodveida ventīlis (I-Ā)</i>				1030 F		<i>Pretvārsts ar sietu</i>			
	1/2"	35/175	3.12	9620001		1/2"	36	4.22	2120004		
	3/4"	18/90	4.65	9620013		3/4"	18	4.80	2120005		
	1"	10/50	7.13	9620014		1"	14	5.87	2120006		
						1,1/4"	8	8.89	2120007		
SLD1016		<i>Lodveida ventīlis ar pieslēguzgriezni</i>				2500/P F		<i>Gružu filtrs ar ausi plombēšanai</i>			
	1/2"	20/100	5.41	9620002		1/2"	12	3.63	2120033		
	3/4"	14/70	9.46	9620023		3/4"		8.46	2120008		
	1"	8/40	12.98	9620044		1"		10.82	2120009		
	1,1/4"	8/32	8.23	9620004		1,1/4"		20.77	2120010		
						1,1/2"		22.62	2120011		
						2"		33.99	2120012		
SLD1018		<i>Lodveida ventīlis (Ā-Ā)</i>				Korķu komplekts alumīnija radiatoriem					
	1/2"	35/175	4.00	9620041	PF RK 552		1/2"Fx1"M	5.55	2120031		
	3/4"	18/90	6.47	9620042	PF RK 553		3/4"Fx1"M	7.25	2120032		
	1"	10/50	6.74	9620043							
SLD1017		<i>Lodveida ventīlis (Ā-Ā)</i>				KAS01		<i>Komplekts taisnais</i>			
	1/2"	24/120	3.90	9620045		1/2"		16.11	3920028		
	3/4"	18/90	6.75	9620046							
	1"	10/50	8.67	9620047							
SLD204		<i>Dārza krāns</i>				KAS02		<i>Komplekts leņķa</i>			
	1/2"	15/60	4.51	9620025		1/2"		15.51	3920029		
	3/4"	10/40	5.83	9620026							
	1"	6/24	3.60	9620027							

Modelis	Apraksts	Izmērs	KV2 m³/h	Artikuls	gab./ iep.	VEIKALS EUR
---------	----------	--------	-------------	----------	---------------	-------------

TERMOVĀRSTI

Termostata vārsti HERZ-TS-90 (divcauruļu sistēmām)

	HERZ-TS-90, taisns Pieslēgšana radiatoram ar konusa blīvslēgu. Universāls modelis ar pieslēgšanu vītņotajai caurulei vai kompresijas savienojumam.	1/2	1.0	1 7723 91	20	14.26
		3/4	1.9	1 7723 92	20	21.71
	HERZ-TS-90, leņķa Pieslēgšana radiatoram ar konusa blīvslēgu. Universāls modelis ar pieslēgšanu vītņotajai caurulei vai kompresijas savienojumam.	1/2	1.0	1 7724 91	20	14.26
		3/4	1.9	1 7724 92	20	21.71
	HERZ-TS-90, aksiāls Pieslēgšana radiatoram ar konusa blīvslēgu. Universāls modelis ar pieslēgšanu vītņotajai caurulei vai kompresijas savienojumam.	1/2	1.0	1 7728 91	20	15.01
	HERZ-TS-90, taisns Pieslēgšana radiatoram ar konusa saskrūvi. Pieslēgšana ar kompresijas savienojumu vītne G3/4 ar konusu.	1/2	1.0	1 7733 81	20	14.26
	HERZ-TS-90, leņķa Pieslēgšana radiatoram ar konusa saskrūvi. Pieslēgšana ar kompresijas savienojumu vītne G3/4 ar konusu.	1/2	1.0	1 7724 37	20	14.26
	HERZ-TS-90-Termostata vārsts, aksiāls, ārējā vītne Pieslēgšana radiatoram ar konusa saskrūvi. Pieslēgšana ar kompresijas savienojumu vītne G3/4.	1/2	1.0	1 7748 91	20	16.95

Termostata komplekti

	HERZ-Termostata komplekts, taisns Komplektā: termostata vārsts 1 7723 91 un termostata vārsta galva 1 7260 06	1/2	1.0	1 7723 60		22.25
	HERZ-Termostata komplekts, leņķa Komplektā: termostata vārsts 1 7724 91 un termostata vārsta galva 1 7260 06	1/2	1.0	1 7724 60		22.25
	HERZ-Termostata komplekts, aksiāls Komplektā: termostata vārsts 1 7728 91 un termostata vārsta galva 1 7260 06	1/2	1.0	1 7728 60		22.86

Termostata vārsti HERZ-TS-E ar maksimālu caurplūdi, jebkurām viencauruļu sistēmām, tai skaitā pašteces, un sistēmām ar lielu patēriņu

	HERZ-TS-E, taisns Pieslēgšana radiatoram ar eirokonusa blīvslēgu. Standarta modelis ar vītņotu muffi.	1/2	1.5 / 5.1	1 7723 11	20	18.41
		3/4	1.5 / 5.1	1 7723 02	20	21.71
		1	1.5 / 5.1	1 7723 03	10	33.09

Termostata trīsceļu vārsti CALIS-TS

	Termostata trīsceļu vārsts CALIS-TS Pieslēgšana sistēmai ar plakano blīvslēgu. Pieslēguma veidgabali pasūtāmi atsevišķi.	1/2	2.75	1 7761 01	10	23.72
		3/4	3.2	1 7761 02	10	23.72

Termostata trīsceļu vārsti CALIS-TS 3-asu 3D izpildījumā (termostata galva horizontālā novietojumā)





	Termostata trīsceļu vārsts CALIS-TS-3D Vārsts pa kreisi no radiatora. Pieslēgšana sistēmai ar plakano blīvslēgu. Pieslēguma veidgabali pasūtāmi atsevišķi.	1/2	3.5	1 7761 43	10	29.44
		3/4	4.2	1 7761 45	10	30.29
	Termostata trīsceļu vārsts CALIS-TS-3D Vārsts pa labi no radiatora. Pieslēgšana sistēmai ar plakano blīvslēgu. Pieslēguma veidgabali pasūtāmi atsevišķi.	1/2	3.5	1 7761 44	10	29.44
		3/4	4.2	1 7761 46	10	30.29

Modelis	Apraksts	Izmērs	KV2 m³/h	Artikuls	gab. J. iep.	VEIKALS EUR
TERMOSTATA VĀRSTU GALVAS						
Termostata vārstu galva HERZ ar vītņi M28x1.5, savietojamas ar HERZ vārstiem						
	Termostata vārsta galva Ar šķidrums sensoru (Hydrosensor), ar pretaižsalšanas 6°C iestatījumu. Iestatāmā temperatūra 6–28°C. Regulēšanas ierobežošana un bloķēšana ar 1 9551 00 (pasūtāms atsevišķi).			1 7260 06	20	12.03
Termostata vārstu galva HERZ "DESIGN MINI", ar vītņi M28x1.5, savietojamas ar HERZ vārstiem						
	Samazinātas formas termostata vārsta galva Ar šķidrums sensoru (Hydrosensor), Regulēšanas diapazons 6–30 °C, ar noslēgšanas "0" un pretaižsalšanas 6 °C iestatījumiem. Ierobežošana un bloķēšana ar 1 9551 02 (pasūtāms atsevišķi). Izmēri: Garums 75 mm, diametrs 45 mm.			1 9200 30	20	13.84
Termostata vārstu galva "HERZCULES", ar vītņi M28x1.5, savietojamas ar HERZ vārstiem						
	Termostata vārsta galva, īpaši stipras konstrukcijas. Vandālisma, zādzības un nepareizas ekaspluatācijas droša. Ar šķidrums sensoru (Hydrosensor), Ieregulējams temperatūras režīms 8–26°C, ar automātisku pretaižsalšanu. Montāža un demontāža tikai ar instrumentiem 1 9554 01 un atslēgu 1 6616 00 (iespējams pasūtīt atsevišķi). Temperatūras režīma iestatīšana ar instrumentu 1 9554 00 (komplektā). Noregulētais regulējums bloķēts. Ieregulējums nobloķētā stāvoklī neredzams.			1 9860 10	20	31.63
Termostata vārstu galva ar uzliekamu kapilāru, ar vītņi M28x1.5, savietojamas ar HERZ vārstiem						
	Termostata vārstu galva ar uzliekamu kapilāru silto grīdu sistēmām Termostata galva ar kapilāru, kapilāra cauruli, stiprinājumu pie caurules. Regulēšanas diapazons 20–50°C, kapilāra caurulītes garums 2000mm.			1 7420 06	10	35.32
Iegremdējama čaula						
	Iegremdējama čaula, misiņa priekš 7420/7421, 9421, ar ārēju 1/2" vītņi.			1 6313 01	20	6.76
Termostata vārstu galva HERZ - DESIGN ar iznestu devēju, ar vītņi M28x1.5, savietojamas ar HERZ vārstiem						
	Termostata vārsta galva ar iznestu devēju Termostats ar šķidrums sensoru (Hydrosensor), kapilāra caurulīte un kapilārs. Temperatūras regulēšanas diapazons 6–30°C, ar noslēgšanas "0" un pretaižsalšanas 6°C iestatījumiem. Ierobežošana un bloķēšana ar 1 9551 00 (pasūtāms atsevišķi). Kapilāra caurules garums 2000 mm.			1 9430 08	10	37.41
Termostata vārstu galva HERZ-H, ar vītņi M 30x1.5, radiatoriem ar iebūvētu vārstu ("Heimeier" un citi)						
	Termostata vārsta galva HERZ "H" Iestatāmā temperatūra 6–28°C, nav mehāniski slēdzama, automātiska pretaižsalšanas temperatūra 6°C. Regulēšanas ierobežošana un bloķēšana ar 1 9551 00 (pasūtāms atsevišķi).			1 7260 98	20	12.03
Termostata vārstu galva "HERZCULES-H", ar vītņi M30x1.5, savietojamas ar HERZ vārstiem						
	Termostata vārsta galva, īpaši stipras konstrukcijas. Vandālisma, zādzības un nepareizas ekaspluatācijas droša. Ar šķidrums sensoru (Hydrosensor), Ieregulējams temperatūras režīms 8–26°C, ar automātisku pretaižsalšanu. Montāža un demontāža tikai ar instrumentiem 1 9554 01 un atslēgu 1 6616 00 (iespējams pasūtīt atsevišķi). Temperatūras režīma iestatīšana ar instrumentu 1 9554 00 (komplektā). Noregulētais regulējums bloķēts. Ieregulējums nobloķētā stāvoklī neredzams.			1 9860 98	20	31.63
Termostata vārstu galva HERZ "DESIGN MINI-H", ar vītņi M30x1.5, savietojamas ar HERZ vārstiem						
	Samazinātas formas termostata vārsta galva GS Ar šķidrums sensoru (Hydrosensor), regulēšanas diapazons 6–30°C, ar noslēgšanas "0" un pretaižsalšanas 6°C iestatījumiem. Ierobežošana un bloķēšana ar 1 9551 02 (pasūtāms atsevišķi).			1 9200 83	20	13.84
Termostata vārstu galva HERZ DESIGN "D" "Danfoss" vārstiem						
	Termostata vārstu galva HERZ "D" Ar šķidrums sensoru (Hydrosensor), regulējamās temperatūras diapazons 6–28°C, nav mehāniski noslēdzama, automātisks pretaižsalšanas 6°C iestatījums. Temperatūras regulējuma ierobežošana un bloķēšana iespējama.			1 7260 99	20	12.03
Termonešēja temperatūras ierobežotājs-regulators HERZ-"MINI"						
	Atpakaļgaitas temperatūras regulēšanas galva, 25-60°C HERZ-MINI Regulē atpakaļgaitas temperatūru robežās 25-60° C, ierobežošana un bloķēšana ar 1 9551 02 (pasūtāms atsevišķi). Savietojama ar HERZ termostata vārstiem.			1 9201 00	10	23.21





Modelis	Apraksts	Izmērs	KV2 m³/h	Artikuls	gab./ iep.	VEIKALS EUR
---------	----------	--------	-------------	----------	---------------	-------------

ATPAKAĻGAITAS NOSLĒGVĀRSTI

Atpakaļgaitas noslēgvārsti HERZ-RL-5, ar iepēju balansēt un iztukšot sistēmu

	HERZ-RL-5, taisns Priekšiestatīšana, uzpilde un izlaišana. Pievienošana radiatoram ar konisku blīvslēgu. Universālais modelis vītņotajai caurulei vai kompresijas savienojumam.	1/2		1 3923 01	20	10.35
		3/4		1 3923 02	20	14.26
	HERZ-RL-5, leņķa Priekšiestatīšana, uzpilde un izlaišana. Pievienošana radiatoram ar konisku blīvslēgu. Universālais modelis vītņotajai caurulei vai kompresijas savienojumam.	1/2		1 3924 01	20	10.35
		3/4		1 3924 02	20	14.26
	HERZ-RL-5, taisns, ārēja vītne Pieslēgšana radiatoram ar eirokonusa saskrūvi. Pieslēgšana sistēmai ar kompresijas savienojumu ārējā vītne G3/4 ar eirokonusu.	1/2		1 3937 11	20	10.50
	HERZ-RL-5, leņķa, ārēja vītne Pieslēgšana radiatoram ar eirokonusa saskrūvi. Pieslēgšana sistēmai ar kompresijas savienojumu ārējā vītne G3/4 ar eirokonusu.	1/2		1 3948 11	20	10.35

Atpakaļgaitas noslēgvārsti HERZ-RL-1

	HERZ-RL-1, taisns Pievienošana radiatoram ar konisku blīvslēgu. Universālais modelis vītņotajai caurulei vai kompresijas savienojumam.	1/2		1 3723 41	20	8.08
		3/4		1 3723 42	20	10.86
	HERZ-RL-1, leņķa Pievienošana radiatoram ar konisku blīvslēgu. Universālais modelis vītņotajai caurulei vai kompresijas savienojumam.	1/2		1 3724 41	20	8.08
		3/4		1 3724 42	20	10.86
	HERZ-RL-1, taisns, ārējā vītne Pieslēgšana radiatoram ar eirokonusa saskrūvi. Pieslēgšana sistēmai ar kompresijas savienojumu ārējā vītne G3/4 ar eirokonusu.	1/2		1 3733 11	20	9.37
	HERZ-RL-1, leņķa, ārējā vītne Pieslēgšana radiatoram ar eirokonusa saskrūvi. Pieslēgšana sistēmai ar kompresijas savienojumu ārējā vītne G3/4 ar eirokonusu.	1/2		1 3748 01	20	9.37

Atpakaļgaitas noslēgvārsti HERZ RL-1-E ar palielinātu caurplūdi

	HERZ-RL-1-E, taisns Pieslēgšana radiatoram ar eirokonusa blīvslēgu. Standarta modelis ar vītņotu muffi.	1/2		1 3723 01	20	23.23
		3/4		1 3723 02	20	26.16
		1		1 3723 03	10	51.65

KOMPRESIJAS SAVIENOJUMI

Eirokonuss pievienojuma veidgabali daudzslāņu un polimēra caurulēm, PE-X, PB-, PE- un daudzslāņu caurulēm

	Kompresijas savienojums plastmasas un daudzslāņu caurulei Blīvējumam izmantoti gumijas gredzeni un kompresijas gredzens. Sastāv no nipeļa, kompresijas gredzena, un gredzena ar vītņi G3/4 eirokonusam.	G 3/4	16x2	1 6098 03	10	3.46
		G 3/4	20x2	1 6098 08	10	3.46

Eirokonuss pievienojuma veidgabali dzelzs un kapara caurulēm

	Pieslēguma veidgabals ar elastīgu blīvējumu Kompresijas gredzens, masīvs gumijas blīvējums (EPDM) un vītņots gredzens ar vītņi G 3/4. Īpaši ieteicams lietot hromētām dzelzs un leģētā tērauda caurulēm.	G 3/4	15	1 6276 15	10	2.96
---	--	-------	----	-----------	----	------

Pievienojuma veidgabali dzelzs un kapara caurulēm

	Pieslēguma veidgabals ar metāla blīvgredzenu. Metāla kompresijas ieliekams gredzens un stiprinājuma nipelis ar konusu.	1/2x15		1 6292 01	10	1.59
---	--	--------	--	-----------	----	------

Modelis	Apraksts	Izmērs	KV2 m³/h	Artikuls	gab. iep.	VEIKALS EUR
---------	----------	--------	-------------	----------	--------------	-------------

DVIEĻU ŽĀVĒTĀJU PIEVIENOJUMI

Leņķa termovārsts divieļu žāvētāja pieslēgšanai VUA-50

	HERZ-VUA-50-leņķa-2-cauruļu sistēma-Design-nalasāma priekšiestatīšana 4-ceļu leņķa vārsts 2-cauruļu sistēmām, ar priekšiestatīšanu, ar plūsmas cauruli L-290mm, D-11mm, bez pārplūdes, ar hromētu pārklājumu, termogalvas pievienojuma vītne-M28x1.5, cauruļu starpcentru attālums-50mm, pievienojuma vītne-M22x1.5	hromēts		S 7684 41	1	65.64
		balts		S 7684 44	1	63.40

Termostata vārstu galva

	Termostatiska galva MINI-GS-Design (hromēta) Ar šķidrums sensoru (Hydrosensor), ar noslēgšanas pozīciju "0" un pretaižsaldīšanas pozīciju 6°C. Temperatūras regulēšana un bloķēšana diapazonā 6–30°C. M28x1.5			S 9200 31	1	29.37
---	--	--	--	------------------	---	--------------

Pieslēguma komplekts – M22x1.5

	Pieslēguma komplekts-Design-M22x1.5 (hromēts) Ar gumijas blīvgredzenu no cauruļu stiprinājuma puses, uzgrieznis M22x1.5 Hromēts uzgrieznis	15		S 6286 15	10	10.75
---	---	----	--	------------------	----	--------------

	Pieslēguma komplekts-Design-M22x1.5 (hromēts) Priekš PE-X, PB un metālpolimēra caurulēm. Kompresijas gredzena uzgrieznis M22x1.5. Hromēts uzgrieznis	16x2		S 6066 16	10	12.19
---	--	------	--	------------------	----	--------------

	HERZ Radiatora termoregulatoru komplekts 1/2", taisns 1762367+1726006+1372341	1/2"		V772301	10	26.13
---	---	------	--	----------------	----	--------------







	HERZ Radiatora termoregulatoru komplekts 1/2", leņķa. 1762467+1726006+1372441	1/2"		V772401	10	26.13
---	---	------	--	----------------	----	--------------

	HERZ Radiatora termoregulatoru komplekts 1/2", aksiālais. 1772891+1726006+1372441	1/2"		V772891	10	26.13
---	---	------	--	----------------	----	--------------

	HERZ stūra ventīlis 1/2"-1/2"	1/2"		1255101		4.18
---	--------------------------------------	------	--	----------------	--	-------------

	HERZ stūra ventīlis 1/2"-3/8" un 3/4"	1/2"		1255201		5.74
---	--	------	--	----------------	--	-------------







Modelis	Apraksts	Izmērs	KV2 m ³ /h	Artikuls	gab./ iep.	VEIKALS EUR
TRĪSCEĻU VĀRSTI						
Termostatisks trīsceļu jaucējvārsts HERZ-TEPLOMIX						
	Termostatisks trīsceļu jaucējvārsts HERZ-TEPLOMIX "Teplomix" 3-ceļu jaucējvārsts ir paredzēts uzstādīšanai katlu apsāistes atpakaļgaitā, temperatūras paaugstināšanai tajā. Rūpnīcas iestatījums sajaukšanas temperatūrai. Ar korķi noslēgts 3/8 pieslēgums tīrīšanai. Maksimālā ekspluatācijas temperatūra 110 °C. Modeļiem 7766 03 un 7766 04 nenoslēdzams "bypass", "bypass" zarā nepieciešams uzstādīt balansējošo vārstu. Temp. atpakaļgaitā 61 °C. Modeļiem 7766 13 un 7766 14 noslēdzams "bypass", temp. atpakaļgaitā 55–63 °C. (maks. novirze 10%). DN 25, Kvs=11; DN 32, Kvs=14	1	11	1 7766 13	1	69.56
		1 1/4	14	1 7766 14	1	71.31
Trīsceļu jaucējvārsts ar rokturi						
	Trīsceļu jaucējvārsts, PN 10 Iekšējās vītnes. Korpus un cilindrs no DZR-misiņa. EPDM blīvējums. Temperatūru diapazons -10°C līdz +110°C.	3/4	6.3	1 2137 02	1	32.67
		1	10	1 2137 03	1	
		1 1/4	16	1 2137 04	1	
Trīsceļu jaucējvārsta motors						
	Trīsceļu jaucējvārsta motors HERZ NR 230-455, 230 V			1 7712 63	1	114.13
Pārplūdes vārsti HERZ, spiediena starpības noturēšanai						
	Pārplūdes vārsts spiediena starpības noturēšanai, taisns Korpus no misiņa, niķelēts. Pieslēgšana sistēmai ar plakanā blīvējuma saskrīvi. Pievienojuma veidgabali pasūtāmi atsevišķi.	1/2	10-2000 l/h	1 4004 31	1	26.41
BALANSIERI						
Balansēšanas vārsti HERZ ar mērdiafragmu un mērnipeļiem, slīps Y-veida						
	Balansēšanas vārsts STRÖMAX FODRV, ar mērdiafragmu un mērnipeļiem spiediena starpības mērīšanai, jaunais modelis Izgatavots no cinka izskalošanas noturīga DZR misiņa, iekšējās vītnes mufē x mufē. Vārpstas blīvējums ar dubultu gredzenu (ORing). Priekšiestatīšana ar stieņa gājienu garuma ierobežošanu, Iestatījuma nolaišana roktura displejā. 2 mērnipeļi (1 0284). Mērījuma nolaišanai mērnipeļu pagarinājumi un drenāžas ventīlis pasūtāmi atsevišķi. Pieslēguma veidgabali: DN 15: adapteris 1 6266 01 un kompresijas savienojums G3/4 (pasūtāms atsevišķi). DN 20: adapteris 1 6266 20 un kompresijas savienojums G3/4 (pasūtāms atsevišķi).	1/2	2.00	1 4017 01	10	39.75
		3/4	3.60	1 4017 02	10	44.17
		1	6.50	1 4017 03	10	52.09
		1 1/4	13.30	1 4017 04	5	62.29
Balansēšanas vārsti HERZ, STRÖMAX-GM, patēriņa mērīšanai un regulēšanai, ar iekšējo vītņi, vārpsta taisna						
	Balansēšanas vārsts STRÖMAX-GM, taisns, ar mērnipeļiem Iekšējās vītnes mufē x mufē; Vārpsta blīvēta ar diviem gumijas blīvgredzēniem O-Ring. Priekšiestatīšana ar gājienu ierobežošanu, Iestatījuma nolaišana roktura displejā. 2 mērnipeļi (1 0284) montēti blakus rokturim. DN 15–DN 50: 2 pieslēgumi ar vītņi 1/4" noslēgti ar korķiem 1 0273 09 DN 65–DN 80: 2 pieslēgumi ar vītņi 3/8" noslēgti ar korķiem 1 0273 00. Priekšiestatīšanas plombe 1 6517 04 un zīme 1 6517 05 komplektā. Nolaišanas vārsts 276 pasūtāms atsevišķi. Pieslēguma veidgabali: DN 15: adapteris 1 6266 01 un kompresijas savienojums G3/4 (pasūtāms atsevišķi) DN 20: adapteris 1 6266 20 un kompresijas savienojums G3/4 (pasūtāms atsevišķi)	1/2	6.00	1 4217 01	10	54.99
		3/4	6.88	1 4217 32	10	
		1	13.23	1 4217 33	10	
		1 1/4	18.91	1 4217 34	5	
Balansēšanas vārsti HERZ 4117 patēriņa regulēšanai un spiediena starpības izmērīšanai, ar slīpu vārpstu, Y-veida						
	Balansēšanas vārsts STRÖMAX-M, patēriņa regulēšanai un spiediena starpības mērīšanai, ar slīpu vārpstu un mērnipeļiem Ar iekšējām vītņēm, vārpstas blīvējums ar gumijas blīvgredzēniem, Priekšiestatīšana ar vārpstas gājienu ierobežošanu. Vārsta sēža blīvējas ar gumijas blīvgredzenu. DN 15–DN 20: 2 pievienojumi ar vītņi 1/4 mērnipeļiem (komplektā mērnipeļi), 1 pievienojums ar vītņi 1/4 nolaišanas vārstam HERZ, noslēgts ar korķi. DN 20–DN 50: 2 pievienojumi ar vītņi 1/4 mērnipeļiem (komplektā mērnipeļi), 2 pievienojums ar vītņi 1/4 nolaišanas vārstam HERZ, noslēgts ar korķi. DN 65–DN 80: 2 pievienojumi ar vītņi 1/4 mērnipeļiem (komplektā mērnipeļi), 2 pievienojums ar vītņi 3/8 nolaišanas vārstam HERZ, noslēgts ar korķi. Pieslēguma veidgabali: DN 15: Universālais modelis vītņotas caurules pievienošanai vai kompresijas savienojumiem. DN 20: Adapteris 1 6266 20 un kompresijas savienojums ar vītņi G3/4. Adapteris un kompresijas savienojums pasūtāms atsevišķi.	1/2	4.75	1 4117 51	10	24.36
		3/4	6.12	1 4117 52	10	32.42
		1	10.40	1 4117 53	10	39.62
		1 1/4	15.97	1 4117 54	5	53.53





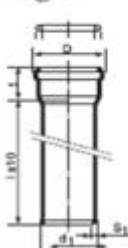

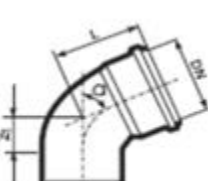

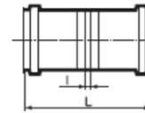



HERZ

Apraksts	Artikuls	Mērv.	VEIKALS
HERZ-LINE PE-RT 16x2mm, sarkana, 240m rullī	HZ162240 (6319029)	m	€ 0.72
HERZ-LINE PE-RT 16x2mm, sarkana, 480m rullī	HZ162480 (6319030)	m	€ 0.72
HERZ-LINE PE-RT 16x2mm, sarkana, 600m rullī	HZ162600 (6319023)	m	€ 0.88
HERZ-LINE PE-RT 20x2mm, sarkana, 240m rullī	HZ202240 (6319024)	m	€ 1.01

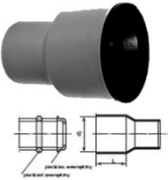

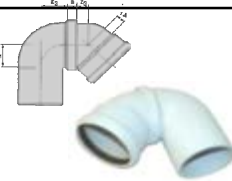

Tehniskais parametrs	16x2.0	17x2.0	20x2.0
Materiāls	PE-RT Polietilēns ar augstu temperatūras noturību	PE-RT Polietilēns ar augstu temperatūras noturību	PE-RT Polietilēns ar augstu temperatūras noturību
Pasūtīšanas apzīmējums	PE-RT 16X2	PE-RT 17X2	PE-RT 20X2
Tips	5-sāņu plastmasas caurule	5-sāņu plastmasas caurule	5-sāņu plastmasas caurule
Ārējais diametrs (mm)	16	17	20
Sieniņas biezums (mm)	2	2	2
Iekšējais diametrs (mm)	12	13	16
Caurules svārs(g./m)	90	100	120
Svārs ar ūdeni (g./m)	203	233	321
Iekšējais tilpums (l/m)	0.113	0.133	0.201
Izplešanās koeficients (mm/mK)	0.19	0.19	0.19
Siltumvadītspēja (W/mK) vidējā	0.35	0.35	0.35
Skābekļa difūzija (mg/lđ)	<0.1	<0.1	<0.1
Maksimālā darba temperatūra (°C)	70	70	70
Maksimālais darba spiediens (bar) pie 70°C	6	6	6
Ārkārtas temperatūras noturība °C	90	90	90
Blīvums (g/cm ³)	0.933	0.933	0.933
Liekšanas rādiuss *	5 x od	5 x od	5 x od
Krāsa	Sarkana	Sarkana	Sarkana
Metri rullī (m)	240, 480, 600	240	240
Slāņu struktūra	PE-RT Adhezīvs (līme) Skābekļa barjera Adhezīvs (līme) PE-RT	PE-RT Adhezīvs (līme) Skābekļa barjera Adhezīvs (līme) PE-RT	PE-RT Adhezīvs (līme) Skābekļa barjera Adhezīvs (līme) PE-RT
Pielietojums	Silto grīdu un sienas paneļu apsildes sistēmās	Silto grīdu un sienas paneļu apsildes sistēmās	Silto grīdu un sienas paneļu apsildes sistēmās









	VEIKALS	EUR		VEIKALS	EUR	
 	800		<i>Caurule ar uznavu</i>	802		<i>Atzars</i>
	DN 32/250	0.86	6180001	DN 50/32; 45°	1.63	6180041
	DN 32/500	1.01	6180002	DN 50/32; 67°	1.81	6180042
	DN 32/1000	1.66	6180003	DN 50/32; 90°	1.65	6180043
	DN 32/2000	2.94	6180004	DN 50/40; 45°	2.05	6180118
	DN 40/150	0.99	6180111	DN 50/40; 67°	2.11	6180113
	DN 40/250	1.07	6180005	DN 50/40; 90°	2.11	6180119
	DN 40/500	1.17	6180006	DN 50/50; 45°	1.18	6180044
	DN 40/1000	1.76	6180007	DN 50/50; 67°	1.18	6180045
	DN 40/1500	5.00	6180112	DN 50/50; 90°	1.18	6180046
	DN 40/2000	3.84	6180008	DN 75/50; 45°	2.33	6180075
	DN 50/150	1.00	6180110	DN 75/50; 67°	2.32	6180076
	DN 50/250	1.12	6180009	DN 75/50; 90°	2.33	6180077
	DN 50/500	1.21	6180010	DN 75/75; 45°	2.34	6180072
	DN 50/1000	1.94	6180011	DN 75/75; 67°	2.40	6180073
	DN 50/1500	3.07	6180089	DN 75/75; 90°	2.35	6180074
	DN 50/2000	3.45	6180012	DN 110/50; 45°	2.24	6180047
	DN 75/150	1.88	6180116	DN 110/50; 67°	2.19	6180048
	DN 75/250	1.72	6180066	DN 110/50; 90°	2.19	6180049
	DN 75/500	2.35	6180067	DN 110/75; 45°	3.99	6180071
	DN 75/1000	3.60	6180068	DN 110/75; 67°	4.69	6180104
	DN 75/2000	6.64	6180069	DN 110/75; 90°	3.51	6180070
	DN 110/150	2.14	6180109	DN 110/110; 45°	2.96	6180050
	DN 110/250	2.00	6180013	DN 110/110; 67°	2.81	6180051
	DN 110/500	2.94	6180014	DN 110/110; 90°	2.86	6180052
	DN 110/1000	4.72	6180015			
	DN 110/1500	7.62	6180088	803		<i>Redukcija garā</i>
	DN 110/2000	8.31	6180016	DN 40/32 (BALTA)	1.29	6180097
				DN 50/32 (BALTA)	0.85	6180053
				DN 50/40	0.87	6180054
				DN 75/50	1.52	6180085
				DN 110/50	1.15	6180055
			DN 110/75	1.61	6180081	
 	801		<i>Līkums</i>	804		<i>Dubultatzars</i>
	DN 32/15°	0.77	6180017	DN 50/50/50; 45°	3.81	6180096
	DN 32/30°	0.71	6180018	DN 50/50/50; 67°	3.58	6180107
	DN 32/45°	0.71	6180019	DN 50/50/50; 90°	3.53	6180087
	DN 32/67°	0.73	6180020	DN 110/50/50; 45°	10.93	6180100
	DN 32/90°	0.71	6180021	DN 110/50/50; 67°	10.41	6180108
	DN 40/15°	1.12	6180092	DN 110/50/50; 90°	9.99	6180101
	DN 40/30°	0.77	6180091	DN 110/75/75; 67°	8.15	6180121
	DN 40/45°	0.70	6180022	DN 110/110/110; 45°	9.00	6180094
	DN 40/67°	1.12	6180090	DN 110/110/110; 67°	7.98	6180106
	DN 40/90°	0.70	6180023	DN 110/110/110; 90°	7.85	6180095
	DN 50/15°	0.75	6180024			
	DN 50/20°	0.75	6180025			
	DN 50/30°	0.70	6180026			
	DN 50/45°	0.70	6180027			
	DN 50/67°	0.70	6180028			
	DN 50/90°	0.70	6180029			
	DN 75/15°	1.53	6180117			
	DN 75/30°	1.74	6180083			
	DN 75/45°	1.69	6180079			
	DN 75/67°	1.70	6180084			
DN 75/90°	1.60	6180078				
DN 110/15°	1.55	6180030				
DN 110/20°	1.89	6180031				
DN 110/30°	1.60	6180032				
DN 110/45°	1.65	6180033				
DN 110/67°	1.67	6180034				
DN 110/90°	1.84	6180035				
	802		<i>Atzars</i>	805		<i>Stūra dubultatzars</i>
	DN 32/32; 45°	1.32	6180036	DN 110/110/110; 67°	22.36	6180123
	DN 32/32; 67°	1.27	6180037	DN 110/110/110; 90°	14.44	6180105
	DN 32/32; 90°	1.32	6180038			
	DN 40/40; 45°	1.64	6180039			
	DN 40/40; 67°	1.53	6180093			
DN 40/40; 90°	1.58	6180040				
 	806		<i>Dubultuzmava ar ierobežotāju</i>	806		
	DN 40	1.42	6180056	DN 40	1.42	6180056
	DN 50	1.38	6180057	DN 50	1.38	6180057
	DN 75	2.53	6180082	DN 75	2.53	6180082
	DN 110	2.63	6180058	DN 110	2.63	6180058

IEKŠĒJĀ KANALIZĀCIJA

	807		<i>Revīzija</i>
	DN 50	1.64	6180059
	DN 75	3.53	6180080
	DN 110	3.36	6180060
	808		<i>Slīdmufe</i>
	DN 32	1.07	6180061
	DN 40	1.24	6180062
	DN 50	1.32	6180063
	DN 75	2.77	6180086
	DN 110	2.46	6180064
	809		<i>Kompensators</i>
	DN 40	2.47	6180114
	DN 50	2.58	6180099
	DN 75	3.76	6180124
	DN110	4.14	6180098
	810		<i>Korķis</i>
	DN 32	0.54	6180126
	DN 40	0.62	6180152
	DN 50	0.54	6180134
	DN 75	0.93	6180153
	DN 110	0.86	6180135
	811		<i>Pāreja uz čugunu ar gumiju</i>
	DN 50	2.78	6180136
	DN 75	4.50	6180125
	DN 110	5.17	6180137
	DN 160	8.20	6180145
	812		<i>Gaisa vārsts</i>
	DN 50	3.12	6180132
	DN 75	4.33	6180154
	DN 110	16.99	6180133
	817		<i>Gaisa vārsts Ø50</i>
	50	5.28	6180139
	110	12.49	6180140
	814		<i>Redukcijas līkums</i>
	50/32; 90°	0.75	6180065
	815		<i>Grozāms līkums</i>
	DN 50 (BALT)	1.58	6180127
	DN 100 (BAL)	4.27	6180128
	819		<i>Ventilācijas jumtiņš</i>
	50	3.38	6180141
	110	8.40	6180142
			<i>Kanalizācijas gaisa vārsts</i>
	CEP3240	17.24	6180161
	CEP4050	19.31	6180157
	CEP100	31.20	6180158













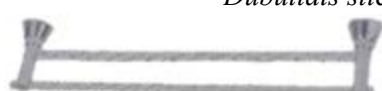

	816		<i>Labošanas uzdeva - pāreja</i>
	DN 50	3.19	6180159
	DN 110	4.93	6180150
	803Z		<i>Redukcija zemā</i>
	DN 110/50	1.89	6180115
	DN 110/75	2.23	6180146
	DN 40/32	1.18	6180147
	DN 50/40	1.18	6180148
	DN 75/50	1.34	6180149
	823		<i>Labošanas redukcija</i>
	DN 110/50	3.95	6180151
	FKV00A0		<i>WC pretnopludināšanas vārsts</i>
	DN 110	7.90	6880012
			<i>Univers.pieslēgums kanalizācijai</i>
	COS0A48 DN 110/40	15.50	6850045
	COS0A58 DN 110/50	15.50	6850046
	5000		<i>Kanalizācijas pretvārsts</i>
	Ø50	16.69	6180138
	GEB-GEBEX PLUS		
	400 gr	5.11	6766025
	Uz silikona bāzes veidota formula visu veidu cauruļvadu eļļošanai: plastmasas, čuguna, betona, u.c., kā arī gumijas blīvju aizsardzībai jebkuros laika apstākļos.		
	GEB-GEBEX		
	200 gr	3.62	6766015
	500 gr	5.17	6766016
Montāžas smēre cauruļvadiem kura nesatur silikonu. Pielieto plastikas cauruļvadu montāžā, uzdevās un gumijas blīvju uzstādīšanā u.c. *Piemērots spiediena un kanalizācijas caurulēm. *Nodrošina vieglu slīdēšanu. *Aizsargā gumijas blīvējumus.			
	813		<i>HT smērviela</i>
	150 gr.	3.23	6866003
	250 gr.	3.76	6866004
	1000 gr	10.25	6866005
			<i>Troše cauruļu tīrīšanai</i>
	150 cm	4.45	7435001
	250 cm	5.84	7435002
	350 cm	7.71	7435003
	500 cm	10.34	7435004
	750 cm	20.79	7435005
	VANTUSS		<i>Vantūzis</i>
		4.15	2935007

	VEIKALS	EUR	
850	<i>Caurule ar uznavu SN4</i>		
	DN 110/500	5.37	5467001
	DN 110/1000	6.37	5467002
	DN 110/2000	11.79	5467003
	DN 110/3000	19.83	5467004
	DN 125/500	5.97	5467008
	DN 125/1000	8.07	5467009
	DN 125/2000	16.36	5467010
	DN 160/500	9.22	5467012
	DN 160/1000	11.43	5467013
	DN 160/2000	21.65	5467014
	DN 160/3000	33.48	5467015
	DN 200/1000	18.09	5467019
	DN 200/2000	34.27	5467020
	DN 200/3000	53.74	5467021
850/8	<i>Caurule ar uznavu SN8, trīsslāņu</i>		
	DN 110/500		5467098
	DN 110/1000		5467024
	DN 110/2000		5467025
	DN 110/3000		5467007
	DN 160/500	7.74	5467099
	DN 160/1000		5467029
	DN 160/2000	20.35	5467030
	DN 160/3000	30.52	5467031
	DN 200/1000		5467034
	DN 200/2000		5467035
	DN 200/3000	47.97	5467036
851	<i>Līkums</i>		
	DN 110/15°	2.13	5467039
	DN 110/30°	2.39	5467040
	DN 110/45°	2.39	5467041
	DN 110/67°	2.69	5467042
	DN 110/87,5°	2.95	5467043
	DN 125/15°	4.06	5467044
	DN 125/30°	2.69	5467045
	DN 125/45°	4.80	5467046
	DN 125/67°	4.34	5467047
	DN 125/87,5°	5.42	5467048
	DN 160/15°	5.18	5467049
	DN 160/30°	4.68	5467050
	DN 160/45°	5.06	5467051
	DN 160/67°	9.08	5467052
	DN 160/87,5°	9.37	5467053
	DN 200/15°	12.99	5467054
	DN 200/30°	12.99	5467055
	DN 200/45°	12.96	5467056
	DN 200/67°	12.71	5467057
	DN 200/87,5°	14.25	5467058
861	<i>Pāreja uz čugunu ar gumiju</i>		
	DN110	9.28	5467101
	DN160	13.98	5467102











	VEIKALS	EUR	
852	<i>Atzars</i>		
	DN 110/110; 45°	5.47	5467059
	DN 110/110; 67°	4.55	5467060
	DN 110/110; 87°	4.26	5467061
	DN 125/110; 45°	6.48	5467062
	DN 125/110; 87°	5.61	5467063
	DN 125/125; 45°	7.67	5467064
	DN 125/125; 87°	8.11	5467065
	DN 160/110; 45°	8.54	5467066
	DN 160/110; 87°	11.12	5467067
	DN 160/125; 45°	11.02	5467068
	DN 160/125; 87°	9.77	5467069
	DN 160/160; 45°	12.95	5467070
	DN 160/160; 87°	12.08	5467071
	DN 200/110; 45°	20.09	5467072
	DN 200/110; 87°	15.16	5467073
	DN 200/125; 45°	16.32	5467074
	DN 200/125; 87°	14.96	5467075
	DN 200/160; 45°	22.03	5467076
	DN 200/160; 87°	20.45	5467077
	DN 200/200; 45°	27.91	5467078
	DN 200/200; 87°	22.94	5467079
853	<i>Redukcija</i>		
	DN 125/110	5.89	5467080
	DN 160/110	3.81	5467081
	DN 160/125	3.95	5467082
	DN 200/160	9.84	5467084
856	<i>Dubultuzmava ar ierobežotāju</i>		
	DN 110	4.62	5467026
	DN 125	3.75	5467106
	DN 160	5.98	5467027
	DN 200	12.64	5467028
858	<i>Slīdmufe</i>		
	DN 110	3.35	5467085
	DN 125	3.89	5467086
	DN 160	5.10	5467087
	DN 200	10.96	5467088
857	<i>Revīzija</i>		
	DN 110	7.22	5467089
	DN 160	13.82	5467090
	DN 200	68.30	5467091
857-VS	<i>Revīzija ar skrūvēm</i>		
	DN 160	22.22	5467096
	DN 200	56.93	5467097
860	<i>Korķis</i>		
	DN 110	1.52	5467092
	DN 160	2.66	5467093
	DN 200	4.79	5467094
5000	<i>Pretvārstis</i>		
	DN 110	44.36	5467103
	DN 160	59.01	5467104
	DN 200	138.93	5467105
866	<i>Labošanas uzmava - pāreja</i>		
	DN 110	5.53	5467100

EUR		EUR	
	83724C Stienis dvieļiem (60 cm)	12.67 137	1131046 6.30
	83780C BLISTERIS Riņķis dvieļiem	5.90 18	1131049 3.50
	83782C Āķītis dubultais	4.34 151	1131050 2.65
	83784C BLISTERIS Glāze ar	6.14 131	1131051 3.60
	83781C BLISTERIS Šķidro ziepju trauks ar turētāju un dozatoru	9.47 126	7131010 5.30
	83787C Stikla plaukts	12.52 191	1131048 7.50
	Tualetes papīra turētājs 83786C	300	1131044 7.20
	85011 Ziepju trauks, metāla	17.36 76	1131069 8.50
	85024C Stienis dvieļiem (60 cm)	21.32 61	1131070 12.00
	85080C Stienis dvieļiem	15.61 65	1131072 8.80
	85084C Glāze ar sienas stiprinājumu	13.68 134	1131074 6.30
	85084D Dubulta glāze ar sienas stiprinājumu	19.16 17	1131077 12.50
	85085 Ziepju trauks	13.68 24	1131075 8.50
	85088 Poda birste ar keramikas trauciņu	21.05 74	1131079 11.00

VANNAS ISTABAS AKSESUĀRI

	VEIKALS EUR		VEIKALS EUR
84211C <i>Ziepju trauks, metāla</i> 	16.26	1131034	8.48
	8	10.20	308
84224C <i>Stienis dvieļiem (60 cm)</i> 	27.45	1131031	12.68
	132	15.00	205
84224DC <i>Dubultais stienis dvieļiem (60 cm)</i> 	41.93	1131032	21.54
	132	20.00	95
84280C <i>Stienis dvieļiem</i> 	13.31	1131033	7.13
	21	8.20	308
84282C <i>Āķītis</i> 	9.47	1131035	11.31
	1	7.00	60
84284C <i>Glāze ar sienas stiprinājumu</i> 	15.64	1131055	8.30
	257	7.30	
84284DC <i>Dubulta glāze ar sienas stiprinājumu</i> 	18.22	1131036	
	68	10.00	
84285C <i>Ziepju trauks (stikla)</i> 	14.53	1131037	
	222	7.20	
84288C <i>Poda birste ar keramikas trauciņu</i> 	19.76	1131040	
	101	11.70	
84711 <i>Ziepju trauks, metāla</i> 		1131056	
			6.00
84724C <i>Stienis dvieļiem (60 cm)</i> 		1131058	
			9.40
84724DC <i>Dubultais stienis dvieļiem (60 cm)</i> 		1131059	
			16.00
84784C <i>Glāze ar sienas stiprinājumu</i> 		1131062	
			5.30
84788 <i>Poda birste ar keramikas trauciņu</i> 		1131067	
			8.30

VANNAS ISTABAS AKSESUĀRI

		EUR				EUR	
86085	Ziepju trauks	15.02	7131006	214	8.80	86087	Stikla plaukts
						24.66	7131001
						139	13.50
86024	Stienis dvieļiem (60 cm)	23.18	7131007	211	14.00		
						86088	Poda birste ar keramikas trauciņu
						22.36	7131002
						171	13.50
86081	Šķidro ziepju trauks ar turētāju	16.57	7131003	221	10.00		
						H 132	Metāla plauktiņš vannas iztabai
						320x232x45	7.33
						24	5.40
86080	Stienis dvieļiem	12.90	7131004	176	7.80		
						H 210	Metāla plauktiņš vannas iztabai
						155x125x32	3.12
						28	2.30
86082D	Āķītis	10.78	7131008	42	6.50		
						H 212	Metāla plauktiņš vannas iztabai
						175x175x50	3.12
						41	2.30
86084	Glāze ar sienas stiprinājumu	14.70	7131009	223	8.80		Glāze (stikla)
						2.62	1131093
						114	1.60

Invalīdu rokturi

EUR

*EQUA-1500 rokturis sienas stiprinājumu
 ar atbalsta kāju 901*

205.00 2531001

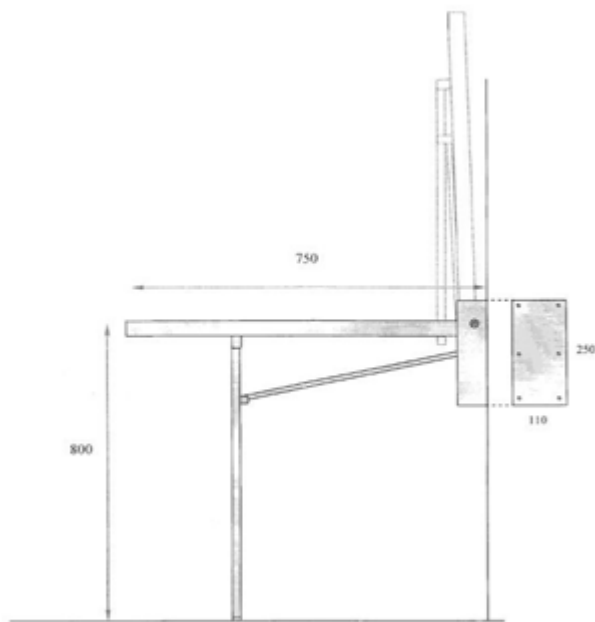

EUR

*EQUA-1501 rokturis sienas stiprinājumu
 ar atbalsta kāju 902*



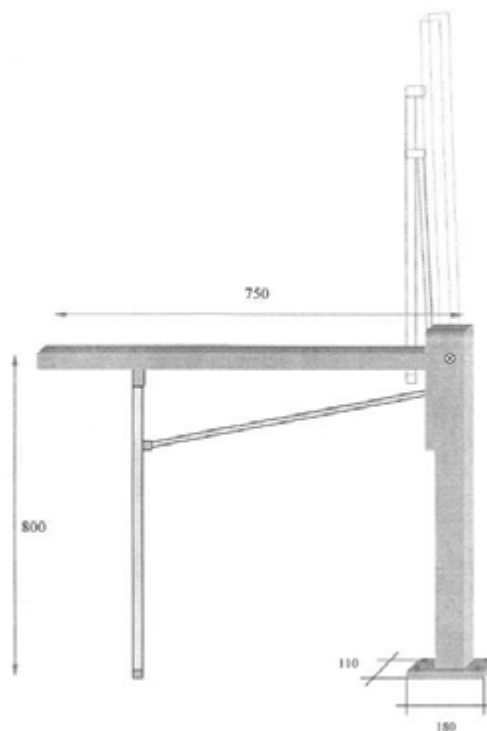





255.00

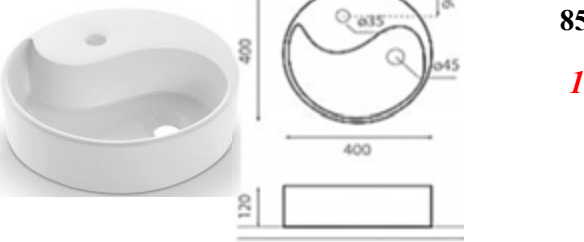
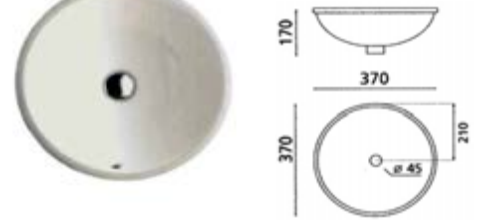

UZLIEKAMĀS KERAMISKĀS IZLIETNES (SPĀNIJA)

VEIKALS EUR

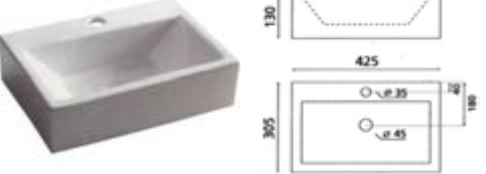
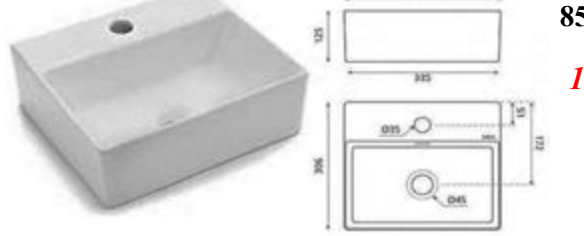
VEIKALS EUR

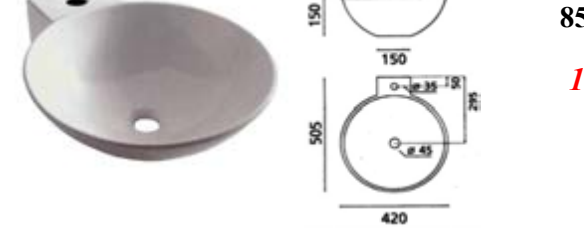
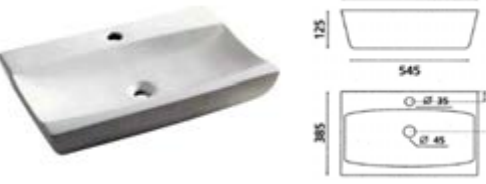
<p>0051B TORINO B</p> <p>8575074 132.60</p> 	<p>0011 CAPRI</p> <p>8575025 131.97</p> 
<p>0051 TORINO</p> <p>8575073 108.15</p> 	<p>0015 CACERES</p> <p>8575005 112.74</p> 
<p>0040B YIN YANG</p> <p>8575045 117.62</p> 	<p>0052 CERDENA</p> <p>8575023 97.89</p> 
<p>0087 DALIA</p> <p>8575019 90.11</p> 	<p>0037 GERONA</p> <p>8575021 126.47</p> 
<p>4913 NEW BERGAMO</p> <p>8575102 117.35</p> 	<p>4056 FLORENCIA-A</p> <p>8575072 123.73</p> 
<p>0028 BAYONA</p> <p>8575009 123.30</p> 	<p>0041 SARDINERO</p> <p>8575022 175.68</p> 

UZLIEKAMĀS KERAMISKĀS IZLIETNES (SPĀNIJA)

VEIKALS EUR

VEIKALS EUR

4122 **DINAN**
 8575093
143.63

4071 **OLEA**
 8575035
157.46

0043 **OPORTO**
 8575013
177.11

0025 **RIMINI**
 8575044
185.05

4010 **TT2**
 8575052
182.21

0023 **MANCHESTER**
 8575029
254.42

0034N **MALAGA NEW**
 8575088
212.85

0024 **VENEZIA**
 8575030
188.95

0062 **FUNCHIAL**
 8575043
147.56











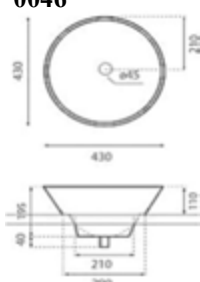

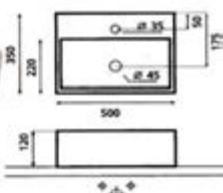

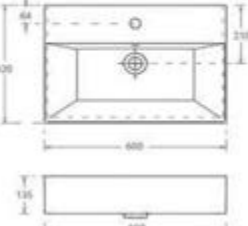

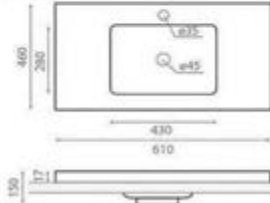

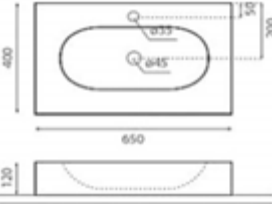

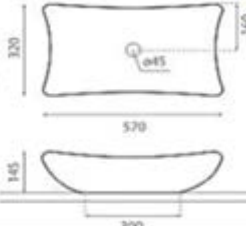

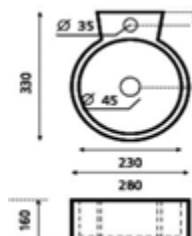
4088 **NILO 60**
 8575083
391.51

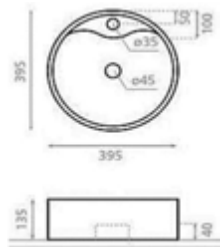
4020 **PURE**
 8575058
179.11

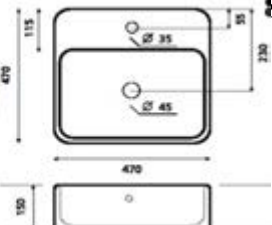
UZLIEKAMĀS KERAMISKĀS IZLIETNES (SPĀNIJA)

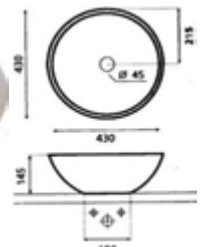
VEIKALS EUR

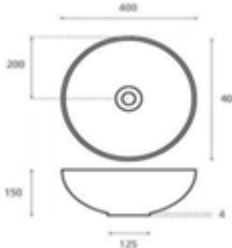
VEIKALS EUR

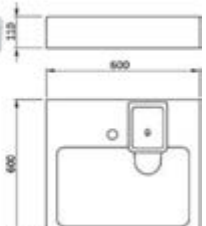
<p>0046 NAPOLIS</p>   <p>8575063 130.07</p>	<p>0017B TURIN</p>   <p>8575050 179.11</p>
<p>4106 BRUSELAS</p>   <p>8575085 236.73</p>	<p>4065 LIEBANA 60</p>   <p>8575103 137.89</p>
<p>0078 ICE CREAM</p>   <p>8575046 204.03</p>	<p>0092B MAGDALENA</p>   <p>8575002 189.77</p>
<p>0066 JEREZ</p>   <p>8575028 113.54</p>	<p>0040N VIENA NEW</p>   <p>8575106 145.60</p>
<p>0064 OROTAVA</p>   <p>8575031 129.98</p>	<p>0012B CASTELLON</p>   <p>8575038 123.02</p>
<p>4069 SICILIA</p>   <p>8575081 134.68</p>	<p>WBX101 Uz velas mašīnas</p>   <p>8275042 179.39</p>

UZLIEKAMĀS KERAMISKĀS IZLIETNES (SPĀNIJA)

VEIKALS EUR



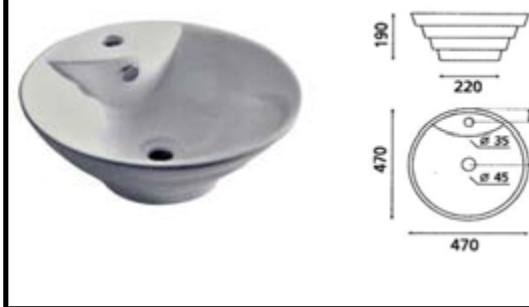
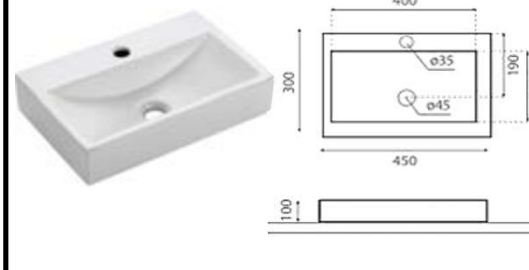
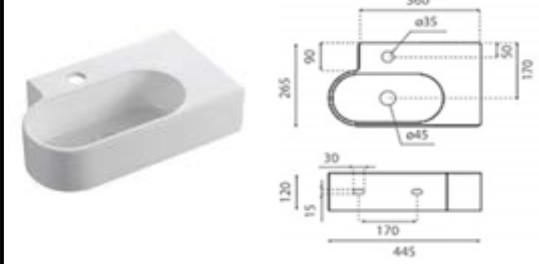
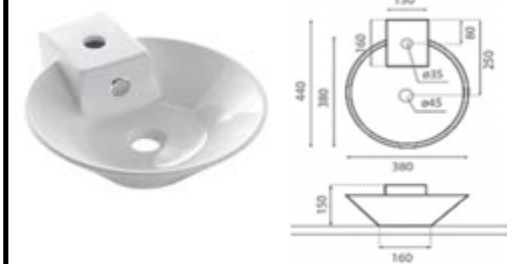



VEIKALS EUR

<p>4037N TOULOUSE</p>  <p>8575087 200.42</p>	<p>4052N NEW VENECIA</p>  <p>8575112 193.00</p>
<p>4109 LIEJA</p>  <p>8575086 179.6</p>	<p>0005 ATLANTA</p>  <p>8575016 126.38</p>
<p>4113 DINAN</p>  <p>8575094 189.12</p>	<p>4058 GENOVA-A</p>  <p>8575075 129.98</p>
<p>0010B BERGAMO</p>  <p>8575049 101.15</p>	<p>0063B LAREDO B</p>  <p>8575054 107.72</p>
<p>4902 RHIN</p>  <p>8575061 126.44</p>	<p>4055 PARIS</p>  <p>8575039 129.54</p>
<p>4051 KABUTO</p>  <p>8575069 118.02</p>	<p>0009B BIARRITZ</p>  <p>8575042 136.05</p>

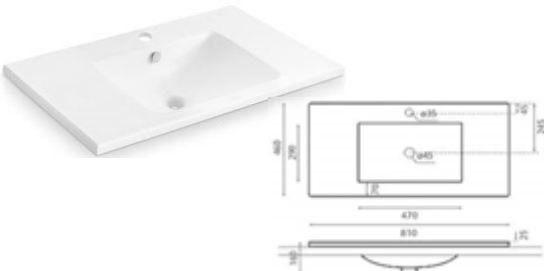
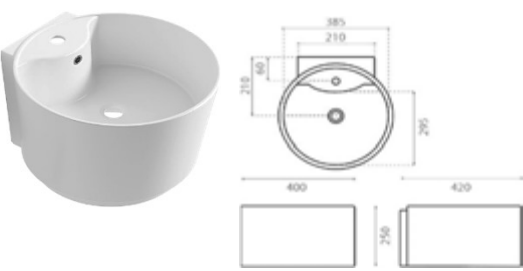
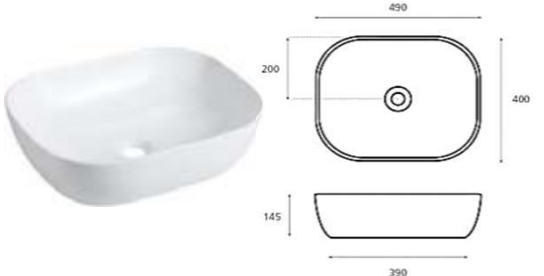
UZLIEKAMĀS KERAMISKĀS IZLIETNES (SPĀNIJA)

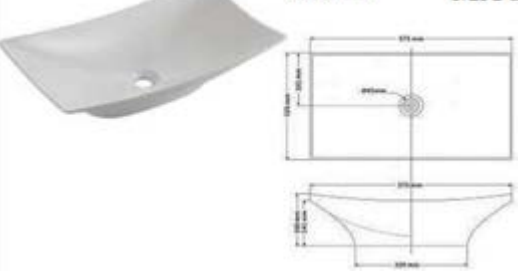
VEIKALS EUR

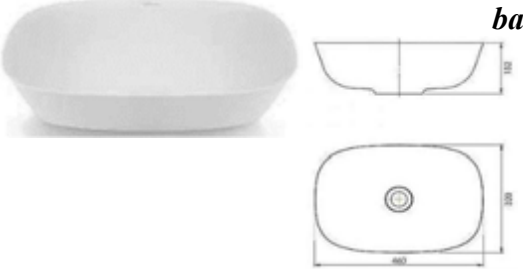
VEIKALS EUR

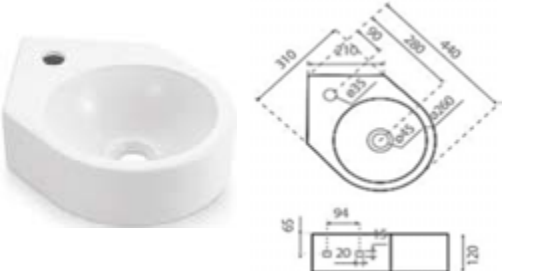
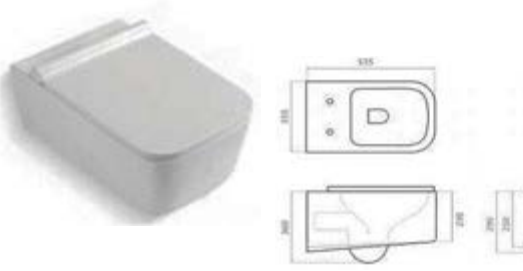
<p>4012/NM NUEVO</p>  <p>8575008 187.04</p>	<p>H1012 HAMBURG</p>  <p>8575010 197.30</p>
<p>4072 OLEA</p>  <p>8575017 175.06</p>	<p>4131 BARI</p>  <p>8575015 154.46</p>
<p>0017D GOMERA</p>  <p>8575068 132.42</p>	<p>0092BN MAGDALENA</p>  <p>8575099 204.65</p>
<p>0067 DUBLIN</p>  <p>8575059 120.80</p>	<p>6039 MENDOZA balta/matēta</p>  <p>8575101 330.43</p>
<p>4087 VOLTA 42 420x125</p>  <p>8575080 185.71</p>	<p>4029 CALIFORNIA 70</p>  <p>8575089 153.82</p>
<p>4049 BRISTOL</p>  <p>8575064 109.08</p>	<p>4533/UF YUCON</p>  <p>8577004 272.53</p>

WATEX ūdens filtri

VEIKALS EUR

SNOW PAD

Dzeramā ūdens filtrs



530.40

8226010

BNT-RO75-C30

Dzeramā ūdens filtrs



219.38

8226011

HT SILVER

Ultrafiltrācijas sistēma



121.84

8226012

VEIKALS EUR

B15 filtra kartridžs

170 l



B008

5.02

2826008

Krūzēm: Standart

B5 filtra kartridžs

300 l



B006

8.67

2826013

Krūzēm: Smile, Prestige un Provance

A5 filtra kartridžs

A5

350 l



9.71

2826010

Krūzēm: Smile, Prestige un Provance

A10









Aquaphor FORAZ
mūļas filtra kartridžs







1.39

2826011

Uz pasūtījumu

VEIKALS
EURVEIKALS
EUR

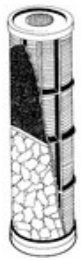
		Aqua KID	
	331000 Aqua KID 5"-1/2"	16.11	2326047
<i>FP3 5"</i>			
	331010 FP3 5"-1/2"	16.88	2326038
	331012 FP3 5"-3/4"	16.90	2326053
	331014 FP3 5"-1"	17.23	2326051
<i>FP3 7"</i>			
	331016 FP3 7"-1/2"	18.11	2326042
	331017 FP3 7"-3/4"	18.18	2326064
	331018 FP3 7"-1"	19.25	
<i>FP3 10"</i>			
	331020 FP3 10"-1/2"	16.69	2326001
	331022 FP3 10"-3/4"	18.33	2326034
	331024 FP3 10"-1"	15.96	2326045
<i>FP3 20"</i>			
	331030 FP3 20"-3/4"	57.01	
	331032 FP3 20"-1"	56.76	2326073
<i>FO3 10"</i>			
	331050 FO3 10"-3/4"	131.14	2326052
	331052 FO3 10"-1"	136.85	
<i>Vital (velas mašīnas filtrs)</i>			
	331320 Vital	10.14	2326023
<i>Mignon 5" 3P 90-tips</i>			
	332002 1/2"	13.82	2326032
<i>Mignon 5" 3P 180-tips</i>			
	332000 1/2"	13.50	2326002









		Aqua KID 5" RLA (neilons)	
	331202 Aqua KID 5" RLA	6.08	2326009
<i>RLA (neilons)</i>			
	331203 7" RLA	7.60	
	331204 10" RLA	7.78	2326008
	331206 20" RLA	20.83	
<i>AC (nerūs.tēr. siets)</i>			
	331210 5"AC	28.06	2326030
	331212 10"AC	38.86	2326031
<i>RLA-CA(neil.+ogle)</i>			
	331240 5" RLA-CA	10.81	2326025
	331242 10" RLA-CA	13.65	2326024
<i>RLA-CP(neil.+polifosfāts)</i>			
	331250 5" RLA-CP	8.23	2326026
	331252 10" RLA-CP	20.14	2326027
<i>Filtra elements 5" dzeltens (PL, 10mikr)</i>			
	331362	4.67	2326035
<p>Mehāniskais elements + polifosfāta sāļi. Šis aukstā ūdens filtrējošais elements nodrošinās ūdens attīrīšanu no mehāniskajiem piemaisījumiem, rūsas, nogulsniem. Polifosfāta sāļi, kas ir filtrējošā elementa sastāvā, reaģējot ar ūdenī esošo kalciju, pārveido kaļķa ķīmisko formulu un mīkstina ūdeni, tādā veidā pasargājot sadzīves tehniku no kaļķakmens veidošanās. Maksimālā ūdens t. 38° C. Šis ir labākais ūdens filtrs Jūsu veļasmašīnai, ūdens boileram vai citai ūdens sildierīcei. Nav ieteicams dzeramajam ūdenim.</p>			













FILTRI, TO ELEMENTI UN APRĪKOJUMS

Uz pasūtījumu







VEIKALS
EUR



VEIKALS
EUR

		AQUA CV kārtidža	
	331260	5"	3.54
	331262	10"	4.53
CA ogle			
	331280	5"	4.17
	331282	10"	7.13
	331284	20"	18.26
CA +I (jonīts + ogle)			
	331286	10" CA+I	6.69
CP polifosfāts			
	331290	5"	9.01
	331292	10"	13.57
	331294	20"	33.7
FA-CA (polipr. + ogle)			
	331310	5"FA-CA	8.65
	331312	10"FA-CA	11.11
Aqua KID FA 5" 10mikroni			
	331328	Aqua KID FA 5"	2.64
FA 5mikroni			
	331330	FA 5"	2.49
	331331	FA 7"	2.71
	331332	FA 10"	3.03
	331334	FA 20"	6.35
FA Mignon 10 mikroni			
	332200	FA 5"	2.64
	332203	FA10" - R	2.71

		Metāla stiprinājums Aqua	
	331500	6.32	2326012
Plastmasas stiprinājums Aqua FP3			
	331502	3.76	2326043
Plastmasas dubultstiprinājums Aqua			
	331504	6.97	2326056
Misiņa atslēga FO3			
	331508	7.56	2326054
Atslēga Aqua korpusiem			
	331510	2.64	2326036
	331516	2.39	2326050
Atslēga Aqua KID korpusiem			
	332304	2.94	2326048
	Atslēga L-tipa mignon korpusiem		
Polifosfāta kristāli			
	331522	Paciņa 800 gr	10.25
	331534	25 kg	238.24
Aktīvā ogle			
	331524	Paciņa 280 gr	2.39
	331536	25 kg	156
Aktīvā ogle+sudrabs			
	331526	Paciņa 250 gr	5.71
	331538	25 kg	35.51
Aktīvā ogle+jonizators			
	331528	Paciņa 400 gr	2.83
Katjona jonīts (10" elementu uzpildei)			
	331530	Paciņa 250 gr	3.67
	331532	25 litri	81.98
Blīve kārtidžām			
	331540	0.89	
O-ring filtru korpusiem			
	331542	FP3	2.18
	331541	Aqua Kid	1.93



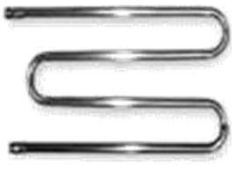

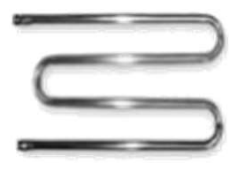
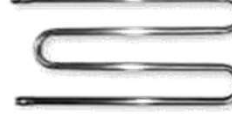

Čūsķveida divieļu žāvētaji



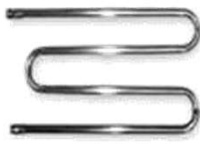

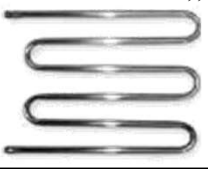







	VEIKALS	EUR
<i>"U veida" 1" (starpcentru attāl. 250 mm ± 15 mm)</i>		
	10013	400 63.72
	10020	450 66.76
	10037	500 69.90
	10044	550 72.98
	10051	600 76.15
	10068	650 79.20
	10075	700 82.31
	10082	750 85.38
	10099	800 88.51
	10105	850 91.56
	10112	900 94.08
<i>"U veida" 1 1/4" (starpcentru attāl. 250 mm ± 15 mm)</i>		
	10228	400 83.60
	10235	450 87.51
	10242	500 91.71
	10259	550 95.80
	10266	600 100.00
	10273	650 104.20
	10280	700 108.40
	10297	750 112.06
	10303	800 116.16
	10310	850 120.36
	10327	900 124.28
<i>"P veida" 3/4" (starpcentru attāl. 500mm ± 15 mm)</i>		
	11645*	500 x 500 53.71
	11652*	500 x 600 59.42
	11669*	500 x 700 65.11
	11881*	500 x 800 70.76
<i>"P veida" 1" (starpcentru attāl. 500mm ± 15 mm)</i>		
	11591*	500 x 500 75.48
	11614*	500 x 600 82.42
	11621*	500 x 700 90.22
	11638*	500 x 800 97.04
<i>"P veida" ar plauktiņu 1" (starpcentru attāl. 600 mm ± 15 mm)</i>		
	17746*	600 x 500 90.01
	17753*	600 x 600 99.29
	17760*	600 x 700 107.13
	18903*	600 x 800 111.60
<i>"P veida" 1 1/4" (starpcentru attāl. 500mm ± 15 mm)</i>		
	11898*	500 x 500 99.08
	11904*	500 x 600 104.98
	11911*	500 x 700 115.69
	11928*	500 x 800 127.69
<i>"Eiro" 1/2" (starpcentru attāl. 500mm ± 15 mm)</i>		
	14639	500 184.53

	VEIKALS	EUR
<i>"M veida" 3/4" (starpcentru attāl. 350 mm ± 15 mm)</i>		
	10921	400 69.97
	10938	450 74.23
	10945	500 78.46
	10952	550 82.70
	10969	600 86.96
	10976	650 91.28
	10983	700 95.47
	10990	750 98.25
	11003	800 104.01
	<i>"M veida" 3/4" (starpcentru attāl. 500 mm ± 15 mm)</i>	
	11324	400 72.08
	11331	450 76.34
	11348	500 80.59
	11355	550 84.87
	11362	600 89.13
	11379	650 93.39
	11386	700 97.62
	11393	750 101.88
	11409	800 106.09
	<i>"M veida" 1" (starpcentru attāl. 500 mm ± 15 mm)</i>	
	10365	400 85.38
	10372	450 91.56
	10341	500 97.79
	10396	550 104.01
	10402	600 110.19
	10419	650 116.46
	10389	700 122.61
	10426	750 128.84
	10433	800 135.04
	<i>"M veida" 1" (starpcentru attāl. 600 mm ± 15 mm)</i>	
	13717*	500 117.36
	13724*	550 124.81
	13731*	600 132.26
	13748*	650 139.74
	13755*	700 147.12
	13762*	750 154.59
	13779*	800 162.02
	<i>"M veida" 1" (starpcentru attāl. 600 mm ± 15 mm) Iekšējā vītne 1/2"</i>	
	12055*	700 122.10

* - ražošanas laiks 1-2 dienas

Čūskveida divieļu žāvētāji







	VEIKALS	EUR
<i>"M veida" ar plauktiņu1" (starpcentru attāl. 600 mm ± 15 mm)</i>		
	13601	500 126.94
	12215	600 142.81
	12246	700 158.71
	12253	800 174.63
<i>"M veida" 11/4" (starpcentru attāl. 550 mm ± 15 mm)</i>		
	11430*	400 133.68
	11447*	450 142.88
	11546*	500 152.25
	11454*	550 161.60
	11560*	600 171.00
	11461*	650 185.92
	11584*	700 189.62
	11478*	750 198.99
	11607*	800 208.32
	11485*	850 220.75
<i>"3 Vīļņu" 3/4" (starpcentru attāl. 580 mm ± 15 mm)</i>		
	11126	400 97.11
	11133	450 102.46
	11140	500 107.76
	11157	550 117.11
	11164	600 120.53
	11171	650 125.83
	11188	700 131.15
<i>"3 Vīļņu" 1/2" (starpcentru attāl. 600 mm ± 15 mm)</i>		
	18408*	500 99.61
	17685*	600 105.07
	18415*	700 110.51
<i>"3 Vīļņu" 1" (starpcentru attāl. 850 mm ± 15 mm)</i>		
	10549	500 134.92
	10556	550 143.55
	10563	600 152.07
	10570	650 160.72
	10587	700 169.19
<i>"3 Vīļņu" 1/2" (starpcentru attāl. 850 mm ± 15 mm)</i>		
	18422	500 107.27
	18439*	600 111.71
<i>"Taurenis" 3/4" (starpcentru attāl. 250 mm ± 15 mm)</i>		
	13830*	500 105.24
	13847*	550 110.81
	13854*	600 116.37
	13861*	650 121.94
	13878*	700 127.45
	13885*	750 132.98
	13892*	800 138.51
<i>"Taurenis" 1" (starpcentru attāl. 250 mm ± 15 mm)</i>		
	10723	600 125.55
	10730	650 132.35
	10747	700 139.07
	10754	750 145.84
	10761	800 152.56





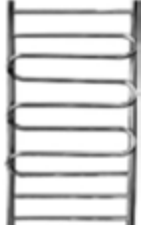
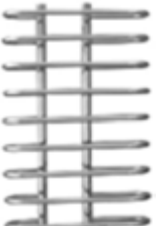

	VEIKALS	EUR
<i>"Step" 1" (starpcentru attāl. 500mm ± 15 mm)</i>		
	19351*	500 x 500 179.91
	19368*	500 x 600 183.79
	19375*	500 x 700 192.05
	19382*	500 x 800 195.36
<i>"Step" 1" (starpcentru attālums 600mm ± 15 mm)</i>		
	19399*	600 x 500 188.86
	19405*	600 x 600 192.96
	19412*	600 x 700 201.66
	19429*	600 x 800 205.13
<i>"Džaz" 1" (starpcentru attāl. 500mm ± 15 mm)</i>		
	18941	500 x 500 138.74
	18965	500 x 600 146.08
	18958	500 x 700 156.28
	18972	500 x 800 165.37
<i>"Džaz" 1" (starpcentru attāl. 600mm ± 15 mm)</i>		
	19474	600 x 500 169.42
	19481	600 x 600 177.36
	19498	600 x 700 186.45
	19504	600 x 800 196.75
<i>"Džaz" 11/4" (starpcentru attāl. 500mm ± 15 mm)</i>		
	19238*	500 x 500 189.97
	19245*	500 x 600 193.60
	19252*	500 x 700 209.64
	19269*	500 x 800 223.73
<i>"Džaz" 11/4" (starpcentru attālums 600mm ± 15 mm)</i>		
	19511*	600 x 500 194.02
	19528*	600 x 600 205.15
	19535*	600 x 700 217.51
	19542*	600 x 800 230.90
<i>"Fokstrots" 1" (starpcentru attāl. 500mm ± 15 mm)</i>		
	11874	500 x 500 139.34
	18866	500 x 600 162.60
<i>"Fokstrots" 1" (starpcentru attāl. 600mm ± 15 mm)</i>		
	14950*	600 x 500 167.27
	16862*	600 x 600 178.40
<i>Regulējams stiprinājums M8 ar gredzenu</i>		
	11683	D 20 3/4" 13.56
	11690	D 25 1" 14.25
	11706	D 32 11/4" 14.97
<i>Neregulējams stiprinājums M8 ar gredzenu</i>		
	12000	D 20 3/4" 12.52
	12017	D 25 1" 13.17
	12024	D 32 11/4" 13.68
<i>Noņemams, regulējams stiprinājums</i>		
	18910	D 20 3/4" 18.21
	18927	D 25 1" 18.97
	18934	D 32 11/4" 26.22
<i>Amerikanka</i>		
	12864	D 20 3/4" 12.08
	12871	D 25 1" 15.48
	12888	D 32 11/4" 22.29

Pulēti nerūsējošā tērauda dvieļu žāvētāji

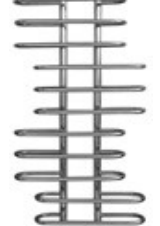
VEIKALS EUR

VEIKALS EUR

	VIKTORIJA	<i>Dvieļu žāvētājs bez plauktiņa</i>	14974 500*600 (5) 168.87
			14561 500*700 (6) 195.15
			14967 500*900 (7) 217.85
			14554 500*1000 (8) 240.25
	VIKTORIJA +	<i>Dvieļu žāvētājs ar plauktiņu starp ribām</i>	14905 500*600 (6) 215.93
			14578 500*700 (7) 242.13
			19672 500*900 (8) 247.91
			14585 500*1000 (9) 259.43
	SONĀTE	<i>Dvieļu žāvētājs bez plauktiņa</i>	14981 500*600 (5) 177.66
			14615 500*700 (6) 200.98
			14998 500*900 (7) 224.56
			14622 500*1000 (8) 247.91
	SONĀTE +	<i>Dvieļu žāvētājs ar plauktiņu starp ribām</i>	14912 500*600 (6) 220.77
			14608 500*700 (7) 244.72
			10198 500*900 (8) 258.11
			14592 500*1000 (9) 267.16
	SONĀTE 2+	<i>Dvieļu žāvētājs ar 2 plauktiņiem ribu vietā</i>	14929 500*900 (9) 263.39
	SONĀTE 3+	<i>Dvieļu žāvētājs ar 3 plauktiņiem ribu vietā</i>	15001 500*900 (9) 270.45
	KAIJA	<i>Dvieļu žāvētājs</i>	15025 500*600 (5) 313.19
			15018 500*900 (7) 270.98
	TANGO	<i>Dvieļu žāvētājs</i>	18026 500*1000 (3) 251.57
	ALLEGRO	<i>Dvieļu žāvētājs</i>	18460 160*700*500 (7) 277.76

	TRIO	<i>Dvieļu žāvētājs</i>	18477 400*700*600 (7) 268.62
	AKKORD	<i>Dvieļu žāvētājs (pulēts)</i>	18484 160*700*650 (7) 277.76
			18507 160*900*650 (9) 326.17
			18521 160*1200*650 (11) 381.26
	AKKORD	<i>Dvieļu žāvētājs (matēts)</i>	18491 160*700*650 (7) 313.97
			18514 160*900*650 (9) 376.47
			18538 160*1200*650 (11) 443.37
	GAMMA	<i>Dvieļu žāvētājs (pulēts)</i>	18545 160*700*500 (7) 268.43
			18569 160*900*500 (9) 316.86
			18583 160*1200*500 (11) 371.94
	GAMMA	<i>Dvieļu žāvētājs (matēts)</i>	18552 160*700*500 (7) 307.15
			18576 160*900*500 (9) 367.19
			18590 160*1200*500 (11) 434.09
	"W"	<i>Dvieļu žāvētājs</i>	18897 500*600 (2) 190.60
			18651 500*1000 (3) 250.27
	"E"	<i>Dvieļu žāvētājs</i>	19320 500*600 (5) 177.20
			18873 500*800 (6) 201.19
			18880 500*1000 (6) 229.17
			19559 500*1200 (8) 252.54
	"R"	<i>Dvieļu žāvētājs</i>	19337 500*600 (5) 169.54
			18804 500*800 (6) 196.10
			18811 500*1000 (6) 220.68

Elektriskie nerūsējošā tērauda dvieļu žāvētāji

VEIKALS EUR

VEIKALS EUR

VIKTORIJA		<i>Dvieļu žāvētājs bez plauktiņa</i>			
	19016	200 W	500*600 (5)	246.01	
	19009	200 W	500*700 (6)	273.59	
	18989	200 W	500*900 (7)	299.14	
	18996	300 W	500*1000 (8)	310.92	

TANGO		<i>Dvieļu žāvētājs</i>			
	19184	300 W	500*1000 (3)	336.23	

VIKTORIJA +		<i>Dvieļu žāvētājs ar plauktiņu starp ribām</i>			
	*19023	200 W	500*600 (6)	286.39	
	*19030	200 W	500*700 (7)	301.29	
	19047	300 W	500*900 (8)	306.91	
	19054	300 W	500*1000 (9)	316.22	
* Žāvētājiem ar augstumu 600 un 700 mm, nav attēlā redzamās atstarpes					

ALLEGRO		<i>Dvieļu žāvētājs</i>			
	19191	200 W	160*700*500 (7)	348.68	

SONĀTE		<i>Dvieļu žāvētājs bez plauktiņa</i>			
	19092	200 W	500*600 (5)	253.02	
	19085	200 W	500*700 (6)	277.60	
	19078	300 W	500*900 (7)	306.20	
	19061	300 W	500*1000 (8)	315.99	

TRIO		<i>Dvieļu žāvētājs</i>			
	19207	200 W	400*700*600 (7)	350.88	

SONĀTE +		<i>Dvieļu žāvētājs ar plauktiņu starp ribām</i>			
	19108	200 W	500*600 (6)	294.58	
	19115	200 W	500*700 (7)	308.03	
	19122	300 W	500*900 (8)	314.87	
	19139	300 W	500*1000 (9)	321.59	

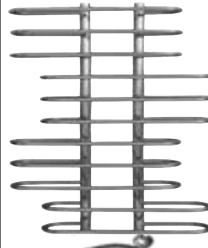
AKKORD		<i>Dvieļu žāvētājs (pulēts)</i>			
	19214	200 W	160*700*650 (7)	363.49	
	19221	300 W	160*900*650 (9)	416.20	
	17616	300 W	160*1200*650 (11)	474.28	

SONĀTE 2+		<i>Dvieļu žāvētājs ar 2 plauktiņiem ribu vietā</i>			
	19146	300 W	500*900 (9)	320.57	

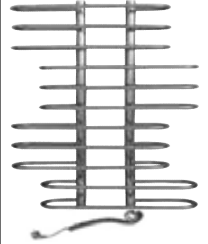
AKKORD		<i>Dvieļu žāvētājs (matēts)</i>			
	17623	200 W	160*700*650 (7)	401.65	
	17630	300 W	160*900*650 (9)	469.23	
	17647	300 W	160*1200*650 (11)	539.67	

SONĀTE 3+		<i>Dvieļu žāvētājs ar 3 plauktiņiem ribu vietā</i>			
	19153	300 W	500*900 (9)	330.96	

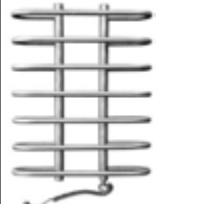

GAMMA		<i>Dvieļu žāvētājs (pulēts)</i>			
	17654	200 W	160*700*500 (7)	539.67	
	17661	300 W	160*900*500 (9)	406.20	
	17678	300 W	160*1200*500 (11)	464.44	

KAIJA		<i>Dvieļu žāvētājs</i>			
	19177	200 W	500*600 (5)	298.89	
	19160	200 W	500*900 (7)	355.07	

GAMMA		<i>Dvieļu žāvētājs (matēts)</i>			
	17692	200 W	160*700*500 (7)	395.86	
	17708	300 W	160*900*500 (9)	459.33	
	17722	300 W	160*1200*500 (11)	530.07	

Dvieļu žāvētāji no cinkotās caurules

VEIKALS EUR

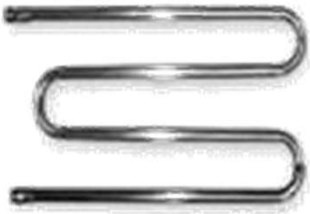
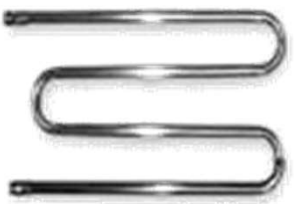
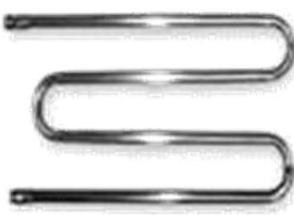
<i>"U veida" 1" (starpcentru attāl. 250 mm ± 15 mm)</i>			
	500	33.41	3660206
	600	37.72	3660128
	700	41.93	3660075
	800	46.21	3660207
<i>"U veida" 1 1/4" (starpcentru attāl. 250 mm ± 15 mm)</i>			
	500	55.97	3660208
	600	63.61	3660209
	700	71.29	3660210
	800	78.93	3660102
<i>"M veida" 3/4" (caurule 25.0x3.2starpcentru attāl. 500 mm ± 15 mm)</i>			
	400	64.23	3660211
	500	68.21	3660212
	600	71.68	3660213
	700	75.02	3660214
	800	78.53	3660215
	900	82.17	3660216
<i>"M veida" 1" (caurule 33.7x3.2starpcentru attāl. 500 mm ± 15 mm)</i>			
	400	60.81	3660283
	500	71.99	3660217
	600	83.49	3660218
	700	95.26	3660124
	800	106.76	3660205
<i>"M veida" 1.1/4" (caurule 42.4x3.2, starpcentru attāl. 550 mm ± 15 mm)</i>			
	500	74.35	3660219
	600	85.08	3660220
	700	90.40	3660221
	800	95.82	3660222

Cinkotie dvieļu žāvētāji ir ekonomiskās klases dvieļu žāvētāji, viņus pārsvarā izmanto objektos, kuros renovē vecos stāvvadus. Cinkotus ieteicams likt uz problēmatiskiem stāvvadiem, kur ir elektrokorozijas pazīmes, vai slikts ūdens, kā Jūrmalā. Varam piedāvāt arī krāsotus modeļus pēc RAL krāsu kataloga. Cena sadārdzinās par 30.00 eur. Krāsoti tiek ar pulverkrāsošanu. Cinkoti dvieļu žāvētāji ir ļoti izturīgi pret elektrokoroziju vai agresīvu ūdeni. Izmēri iespējami arī individuāli.

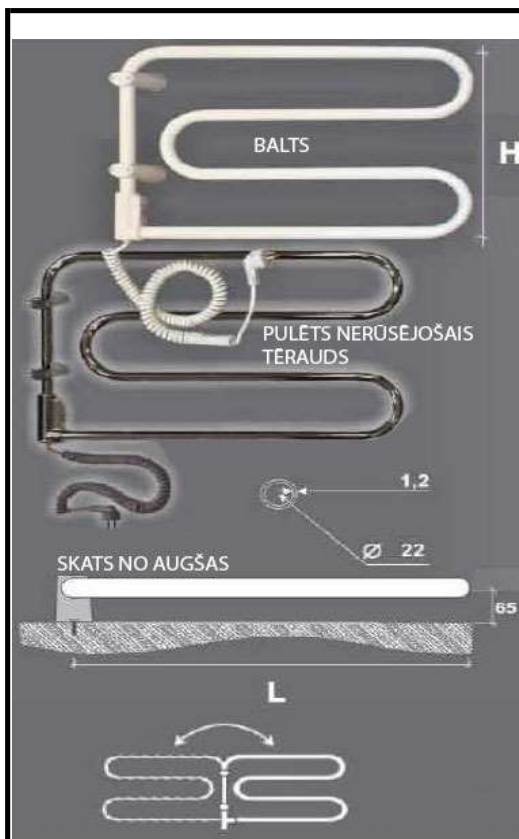

DIVU VIĻŅU (STARP ASĪM H=340)

KLĀJUMS	BALTS (RAL 9010)	PULĒTS
PLATUMS	540	540
SVARS KG	1.86	1.98
JAUDA, W	45	45
CAURULES DIAMETRS	22 mm	22 mm
STIPRINĀJUMI	3	3
KODS	2160004	2160002
PIEGĀDĀTĀJA KODS	5890	5900
CENA EUR AR PVN	92.30	127.10

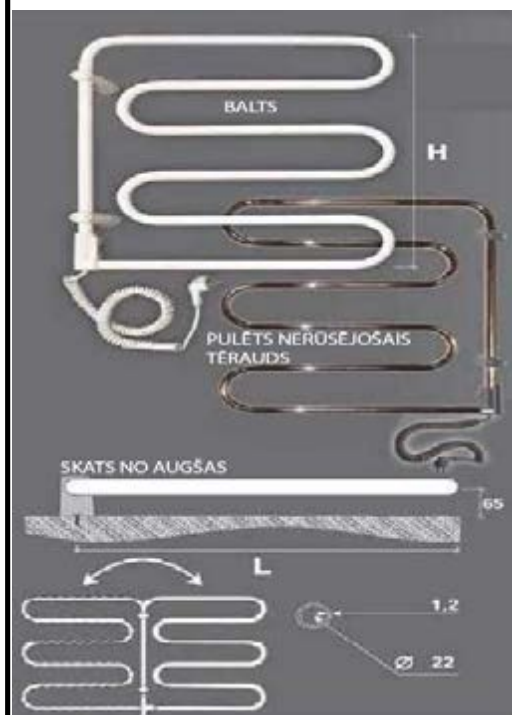

TRĪS VIĻŅU (STARP ASĪM H=560)

KLĀJUMS	BALTS (RAL 9010)	PULĒTS
PLATUMS	520	520
SVARS KG	2.60	3.20
JAUDA, W	70	70
CAURULES DIAMETRS	22 mm	22 mm
STIPRINĀJUMI	3	3
KODS	2160005	2160003
PIEGĀDĀTĀJA KODS	5891	5902
CENA EUR AR PVN	117.74	174.41

ČETRU VIĻŅU (STARP ASĪM H=780)

KLĀJUMS	BALTS (RAL 9010)	PULĒTS
PLATUMS	520	520
SVARS KG	3.47	3.47
JAUDA, W	100	100
CAURULES DIAMETRS	22 mm	22 mm
STIPRINĀJUMI	3	3
KODS	2160006	2160007
PIEGĀDĀTĀJA KODS	5893	5903
CENA EUR AR PVN	163.59	249.77



Elektriskie dviēļu žāvētāji, baltie: Izgatavoti no nerūsējošā tērauda caurules ar eiropas standartu - EN 10305-3. Caurules diametrs 22 mm, sienīņas biezums 1.2 mm. Lai izstrādājuma virsmu aizsargātu no virsmas korozijas, mehāniskiem bojājumiem un ķīmiskas iedarbības tērauda cauruļu virsma tiek slīpēta, attaukota un krāsota ar krāsu EPOXYPOL.TRIBO BT-55 Gloss 10/180°. Krāsa balta - RAL 9010.

Nerūsējošā tērauda elektriskie dviēļu žāvētāji: Izgatavoti no nerūsējošā tērauda caurules ar eiropas standartu - EN 10204. Caurules diametrs 22 mm, sienīņas biezums 1.5 mm.

Dviēļu žāvētāja iekšpusē ir pilnībā drošs sildkabelis. Dviēļu žāvētāja maksimālā uzsilšanas temperatūra ir +60°C, līdz ar to tas ir pilnībā drošs pret pieskārieniem.

VEIKALS EUR















VEIKALS EUR

SPL-Y		<i>Lampa Y</i>	
			9879002
	41	9.73	1.99
SPL-D3		<i>Lampa D3</i>	
			9879003
	6	7.64	1.49
SPL-D39		<i>Lampa D39</i>	
			9879001
	14	13.60	2.99
3.37	SPL-D240	<i>Lampas stikla daļas</i>	9879004
3.37	SPL-D165	<i>Lampas stikla daļas</i>	9879005

VEIKALS EUR

VEIKALS EUR

<i>Komplekts 1/2" ar smidzināšanas uzgali</i>			
	CL8802	13.36	2363067
<i>Komplekts 3/4" ar smidzināšanas uzgali</i>			
	CL8827	18.49	2363101
			
<i>Smidzināšanas uzgalis Plus</i>			
	CL8536	5.44	2363070
<i>Smidzināšanas uzgalis Plus</i>			
	CL8537	6.02	2363081
			
<i>Smidzināšanas uzgalis JET</i>			
	CL8616	3.84	2363021
<i>Smidzināšanas uzgalis JET (blister)</i>			
	CL8617	5.24	2363022
			
<i>Smidzināšanas pistole</i>			
	CL8756	8.30	2363054
			
<i>Daudzfunkciju laistīšanas pistole Garden</i>			
	CL9373	12.94	2363014
			
<i>Smidzināšanas pistole Ergo</i>			
	CL8538	8.50	2363062
<i>Smidzināšanas pistole Ergo</i>			
	CL8539 (BL)	9.76	2363074
<i>Smidzināšanas pistole ar kompl. ERGO</i>			
	CL8551	18.50	2363103
			
<i>Smidzināšanas pistole Ergo</i>			
	CL8541 (BL)	13.54	2363091
			
<i>Laistīšanas pistole Ergo - Garden</i>			
	CL9391 (BL)	15.82	2363072
			
<i>Smidzināšanas pistole</i>			
	CL8966	6.05	2363035
			
<i>Mazgāšanas pistole</i>			
	CL8757 (bl)	11.59	2363051
			
<i>Pistole laistīšanas Precision</i>			
	CL9561 (BL)	20.29	2363080
			

<i>Savienotājs ar iekšējo vītņi</i>			
	CL8622	1/2"	1.71 2363008
	CL8623 (bl)	1/2"	2.31 2363023
	CL8626	3/4"	1.61 2363009
	CL8627 (bl)	3/4"	2.26 2363094
	CL8628	1"	1.78 2363010
	CL8629 (bl)	1"	2.37 2363078
<i>Savienotājs ar ārējo vītņi</i>			
	CL8636	3/4"	1.60 2363007
	CL8637 (bl)	3/4"	2.03 2363075
<i>Remontuzmava</i>			
	CL8618	1/2"	2.37 2363019
	CL8620	5/8*3/4"	3.67 2363020
	CL8621	5/8*3/4"	4.40 2363084
	CL-8619	1/2"	3.16 2363059
<i>Savienotājs</i>			
	CL8606	1/2"	2.33 2363001
	CL8607 (bl)	1/2"	3.49 2363041
	CL8608	3/4"	3.51 2363002
	CL8609 (bl)	3/4"	5.20 2363042
<i>Savienotājs ar aquastop</i>			
	CL8602	1/2"	3.75 2363003
	CL8604	3/4"	4.53 2363004
	CL8603	1/2"	5.46 2363082
	CL8605	3/4"	6.59 2363083
<i>Uzgalis ar 1/2" un 3/4" adapteri</i>			
	CL8591		2.47 2363043
<i>Uzgalis ar 1/2" un 3/4" adapteri (blister)</i>			
	CL8804		2.92 2363102
<i>Savienotājs QUICK-FIT ar aeratoru</i>			
	CL8587		19.28 2363073
<i>Blīvju remontkomplekts</i>			
	CL8811		2.60 2363036
<i>Dīvgabals</i>			
	CL8612		1.95 2363005
	CL8613 (BL)		2.76 2363040
<i>Trejgabals</i>			
	CL8614		3.44 2363006
	CL8615 (BL)		4.10 2363076
<i>Savienotājs Koala</i>			
	CL8583		12.68 2363039
<i>Sadalītājs ar 2 izejām</i>			
	CL8598		10.11 2363052
<i>Ar quick-click</i>			
	CL8599		10.95 2363037
<i>Sadalītājs ar 4 izejām</i>			
	CL8581 (BL)		31.25 2363038
<i>Savienotājs krānam ar I vai A vītņi 3/4"</i>			
	CL8597		18.32 2363099

VEIKALS EUR



VEIKALS EUR

	<i>Laistītājs Idrosprey 2000</i>	CL8675	27.43	2363058
	<i>Daudzfunkciju laistīšanas ierīce</i>	CL8654	16.92	2363024
	<i>Laistītājs Rollina</i>	CL8656	10.94	2363032
	<i>Laistītājs Turbospruzzo</i>	CL8658	9.44	2363033
	<i>Laistītājs Compact 160 Promo</i>	CL8740	16.93	2363027
	<i>Laistītājs Compact-12</i>	CL8748	23.66	2363087
	<i>Laistītājs Impact uz spraudņa</i>	CL8707	27.99	2363086
	<i>Laistītājs Turbospike</i>	CL8660	8.15	2363025
	<i>Automašīnas mazgājamā birste Wippy Car</i>	CL8774	12.63	2363034
	<i>Šampūna stienīši 10 gab</i>	CL8759	3.05	2363066
	<i>Šļūteņu turētājs ECO O</i>	CL8866	5.16	2363068
	<i>Rati Genius 60</i>	CL8862	60.37	2363069
	<i>Rati, izjaucamie, Ecosei</i>	CL8980	43.03	2363090
	<i>Ūdens tvertne roku mazgāšanai 4L</i>	30005	5.43	4475001

* krāsa var mainīties

	<i>Daudzfunkciju laistīšanas pistole QUICK EXCLUSIVE</i>	WL-EN9T	14.64	7863002
		10		
	<i>Daudzfunkciju laistīšanas pistole STANDART</i>	WL-EN1T	10.23	7863003
		10		
	<i>Smidzināšanas uzgalis</i>	WL-4710	1.37	7863001
		10		
	<i>Remontuzmava 1/2"</i>	WL-2100	0.92	7863020
		25/50		
	<i>Remontuzmava 3/4"</i>	WL-2110	1.49	7863021
		25/50		
	<i>Remontuzmava 1"</i>	WL-2112	3.99	7863022
		10		
	<i>Remontuzmava 1/2"x3/4"</i>	WL-2101	1.68	7863025
		25/50		
	<i>Remontuzmava 3/4"x1"</i>	WL-2111	3.44	7863026
		10		
	<i>Savienotājs ar aquastop 1/2"</i>	WL-2140	1.65	7863030
		25/50		
	<i>Savienotājs ar aquastop 3/4"</i>	WL-2150	1.96	7863031
		25/50		
	<i>Savienotājs ar iekšējo vītņi 1/2"</i>	WL-2196	0.57	7863015
		25/50		
	<i>Savienotājs ar iekšējo vītņi 3/4"</i>	WL-2195	0.65	7863016
		25/50		
	<i>Uzgalis 3/4" ar 1/2" adapteri</i>	WL-2198	1.08	7863010
		25/50		
	<i>Uzgalis 1" ar 3/4" adapteri</i>	WL-2199	1.19	7863011
		25/50		
	<i>Divgabals</i>	WL-2200	0.70	7863035
		25		

LAISTĪŠANAS ŠLŪTENES

	VEIKALS	EUR	
			<i>Šļūtene IDRO GREEN</i>
	1/2"-25m	10.57	2362001
	1/2"-50m	21.15	2362002
	3/4"-25m	21.14	2362003
	3/4"-50m	42.38	2362004
	1"-25m	44.90	2362042
	1"-50m	89.74	2362005
			<i>Šļūtene MINT</i>
	1/2"- 25 m	21.92	2362006
	1/2"- 50 m	43.80	2362007
	3/4"- 25 m	38.27	2362008
	3/4 "-50 m	76.52	2362009
			<i>Šļūtene NTS ORANGE</i>
	1/2"-25m	44.23	2362012
	1/2"- 50 m	87.63	2362013
	3/4"- 25 m	77.40	2362014
	3/4 "-50 m	153.25	2362015
	1"x25 m	125.67	2362045
	1"x50 m	251.20	2362016

<p>UZ PASŪTĪJUMU</p>	<p>EPS200</p> <p>CapriTherm</p> <p>Siltuma vadītspēja 0,038W</p> <p>Karstumizturīgums 0,75(m²*k)/W</p>	<p>biezums 30mm</p>	<p><i>Putuārstā plāksne 1M2 siltajam grīdām ar izteiktām siltumizolācijas īpašībām</i></p> <p>5.53</p> <p>1781001</p>								
<p>UZ PASŪTĪJUMU</p>	<p>ACU300</p> <p>CapriAcu</p> <p>Siltuma vadītspēja 0,045W</p> <p>Akustiskā klase PP-28</p> <p>Skavas reducēšana 8dB</p>	<p>biezums 30mm</p>	<p><i>Putuārstā plāksne 1M2 siltajam grīdām ar izteiktām skaņas izolācijas īpašībām</i></p> <p>5.61</p>								
<p>2009</p>		<p>250gb.</p>	<p>Skavas caurulei</p> <p>17.66</p> <p>1722041</p>								
<p>7271S</p>			<p><i>Pe-RT/EVOH/Pe-RT Caurule siltajam grīdām</i></p> <table border="1"> <tr> <td>200M/4 rullis</td> <td>16x2 0</td> <td>0.45</td> <td>4219001</td> </tr> <tr> <td>200M/4 rullis</td> <td>20x2 0</td> <td>0.45</td> <td>4219002</td> </tr> </table>	200M/4 rullis	16x2 0	0.45	4219001	200M/4 rullis	20x2 0	0.45	4219002
200M/4 rullis	16x2 0	0.45	4219001								
200M/4 rullis	20x2 0	0.45	4219002								
<p>91230</p>		<p>1gb</p>	<p><i>Takers skavas stiprināšanai</i></p> <p>260.86</p> <p>1735010</p>								

Roku tīršanas līdzekļi

VEIKALS

EUR

Roku tīršanas līdzeklis CLEAN HARRY GREEN

3263

500 ml.

9.59

2172002



Rūpniecisks roku tīršanas līdzeklis. Paredzēts, lai notīrītu visgrūtāk tīrāmos traipus: taukus, eļļas, dubļus, krāsas, lakas. Ļoti efektīvs līdzeklis. Pilnībā notīra visu veidu netīrumus no rokām un nagiem.

Lieliski piemērots lietošanai mehāniķiem, virpotājiem, celtniekiem, šoferiem, darbiniekiem riepu veikalos, velosipēdistiem, iespaidējiem, u.t.t. Līdzeklis, kas ir nepieciešams katrā garāžā. Tam ir patīkama mandeļu smarža, sviesta konsistence. Krāsa-dzeltena.

Sastāvs: glicerīns, lanolīns (aitas vilnas vasks). Nesatur abrazīvu.

Lietošana: Nemitrināt rokas pirms CLEAN HARRY GREEN lietošanas. Pēc lietošanas noslaucīt rokas ar dvieli vai nomazgāt ar ūdeni.

Līdzekli drīkst izmantot bez ūdens.

Iepakojums: 0,5 kg; 5 kg un 10 kg plastmasas

spainīši.

Roku tīršanas līdzeklis CLEAN HARRY BLUE

3266

500 ml.

4.72

2172003



Rūpniecisks roku tīršanas līdzeklis. Paredzēts, lai notīrītu visgrūtāk tīrāmos traipus: taukus, eļļas, dubļus, krāsas, lakas. Ļoti efektīvs līdzeklis. Pilnībā notīra visu veidu netīrumus no rokām un nagiem.

Lieliski piemērots lietošanai mehāniķiem, virpotājiem, celtniekiem, šoferiem, darbiniekiem riepu veikalos, velosipēdistiem, iespaidējiem, u.t.t. Līdzeklis, kas ir nepieciešams katrā garāžā.

Sastāvs: glicerīns, lanolīns (aitas vilnas vasks), abrazīvs, kas negrimst ūdenī un nepiesārņo sifonus.

Līdzeklim ir daļēji šķidra konsistence, piemīt patīkama citronu smarža. Krāsa-oranža. Lietošana:

Nemitrināt rokas pirms lietošanas. Pēc lietošanas noslaucīt rokas dvielī vai nomazgāt ar ūdeni. Var

lietot traukos ar dozatoru. Līdzeklis mazāk efektīvs nekā FELIX vai CLEAN HARRY GREEN.

Iepakojums: 0,5 kg; 5 kg un 10 kg plastmasas spainīši.

VEIKALS EUR

VEIKALS EUR

**Eko aizdedzināmie koksnes rullīši.**

Ekoloģisks un dabīgs produkts, kas nesatur kaitīgās, ķīmiskās un toksiskās vielas piemēram degvielas, spirtus, utt,

Piemērots kokskaidu brikešu, granulu, ogļu un malkas ātrai aizdedzināšanai, bez citu palīgmateriālu pielietošanas.

Pielietojams grilu, kamīnu, krāšņu un ugunsroku ātrai iekurināšanai. Derīgs arī lielākām pagalēm, koku zariem un pat mitrai meža malkai. Viena iekura gabaliņa degšanas ilgums ir apmēram līdz 10 minūtēm. Tas deg bez nepatīkamās smakas un dūmiem, to var uzglabāt telpās, jo no tā neizdalās nepatīkams aromāts, kas atgādina dažāda veida degvielas.

EKO FENIKS ir Izgatavots no tīras koksnes - vairākiem koku sugu veidiem, tā sastāvā ir tikai dabīgais vasks un koku sveķi.

Aizdedzināmie atbilst: FSC-STD-40-004 V2-1; EN 186-3; Ražots ES, Polijā.

EKO uguns iekurs FENIKS - 6

0.98 2295002

*EKO uguns iekurs FENIKS - 16*

2.54 2295003

*EKO uguns iekurs FENIKS - 3*

0.57 2295001

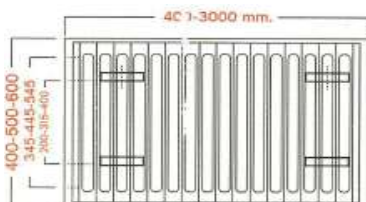

VEIKALS EUR

TYPE 22 PKKP	Augstums	Garums	Jauda W	Cena	Kods
	400	500		66.53	4670002
	400	600		74.41	4670003
	400	800		94.69	4670005
	400	1000		112.75	4670007
	400	1200		132.66	4670009
	400	1400		152.27	4670010

Itek/m = 24,00 Kg, paneļa biezums 1,25-1,20mm, komplektā ietilpst korķis, atgaisotājs un stiprinājumi

TYPE 22 PKKP	Augstums mm	Garums mm	Jauda W	Cena	Kods
	500	400	746	20.33	4670014
	500	500		65.01	4670015
	500	600		72.76	4670016
	500	700		82.61	4670017
	500	800		97.55	4670018
	500	900		108.63	4670019
	500	1000		116.13	4670020
	500	1200		136.54	4670022
	500	1400		148.84	4670023
	500	1600		170.23	4670024
	500	1800		189.39	4670025
	500	2000		210.77	4670026

Itek/m = 28,90 Kg, paneļa biezums 1,25-1,20mm, komplektā ietilpst korķis, atgaisotājs un stiprinājumi



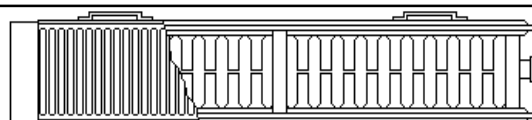

TYPE 22 PKKP	Augstums mm	Garums mm	Jauda W	Cena	Kods
					

Itek/m = 34,60 Kg, paneļa biezums 1,25-1,20mm, komplektā ietilpst korķis, atgaisotājs un stiprinājumi



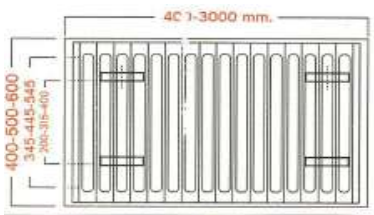
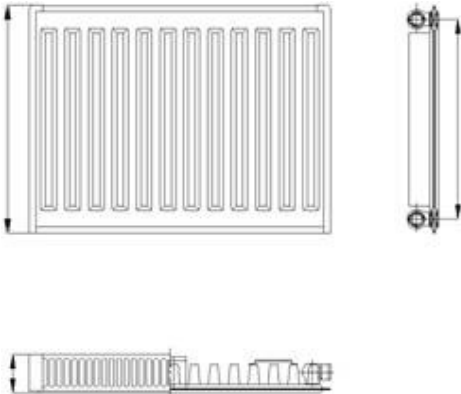

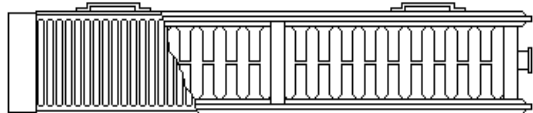
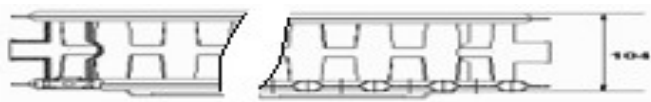











EN 442



TYPE 11 PK	Augstums	Garums	Jauda W	Cena	Kods
	400	800	721	20.47	4670040
<i>Itek/m = 11.40 Kg, paneļa biezums 1,25-1,20mm, komplektā ietilpst korķis, atgaisotājs un stiprinājumi</i>					
TYPE 11 PK	Augstums mm	Garums mm	Jauda W	Cena	Kods
					
<i>Itek/m = 14.20 Kg, paneļa biezums 1,25-1,20mm, komplektā ietilpst korķis, atgaisotājs un stiprinājumi</i>					
TYPE 11 PK	Augstums mm	Garums mm	Jauda W	Cena	Kods
					
<i>Itek/m = 17.00 Kg, paneļa biezums 1,25-1,20mm, komplektā ietilpst korķis, atgaisotājs un stiprinājumi</i>					
					
					
					

VEIKALS EUR











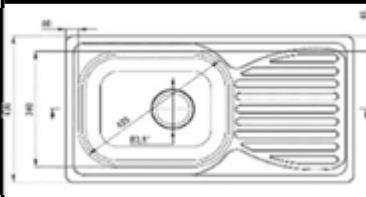
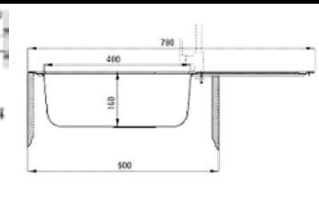

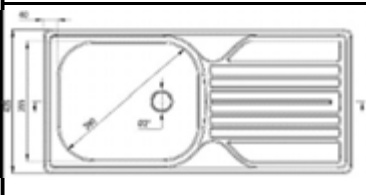
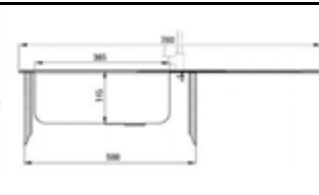
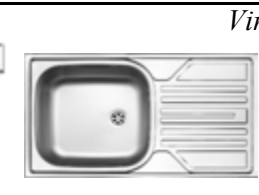
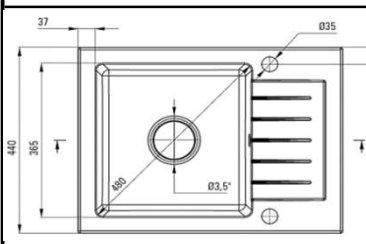
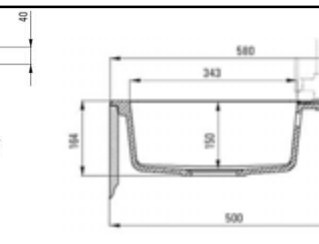
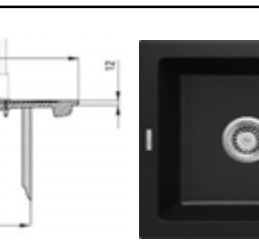
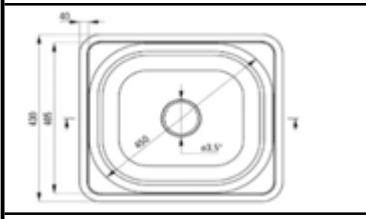
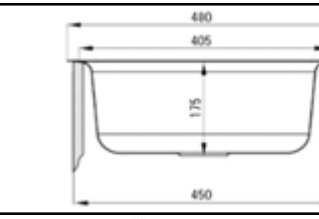

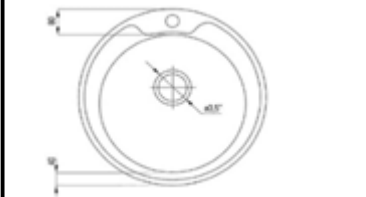
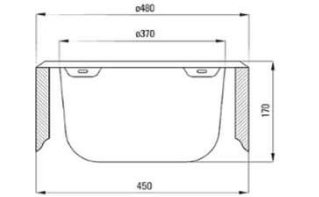
	<i>Skalojamā tvertne, keramiskā, LIDO podiem</i> WC skalojamā kaste "RIO", bez meh., attālums starp skrūvēm 135 mm	32.89 2571005
	<i>Skapis ar izlietni</i> VENUS 45 430x810x250	106.41
	VENUS 50 450x810x290	2576024 131.53
	VENUS 55 520x810x300	144.84
	<i>Skapis ar izlietni</i> MEA 60/1 600x800x400	322.21
	<i>Skapis ar izlietni</i> MEA 75 700x800x330	2576021 251.26
	<i>Skapis ar izlietni</i> MEA 45 430x800x250	2576019 128.59
	MEA 50 460x800x300	152.22
	MEA 55 530x800x310	2576023 168.50
	MEA 65 620x800x300	2576018 206.92
	<i>Skapis ar izlietni</i> CAPRI 55 BLACK 480x800x340	322.21
	<i>Skapis ar izlietni</i> CAPRI 55 480x800x340	322.21

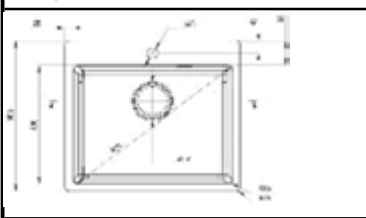
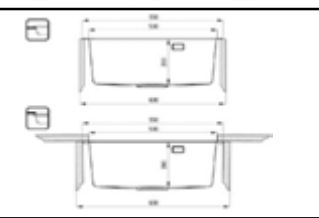
	<i>Skapis ar izlietni</i> ARMANDO 50/1 460x810x300	165.53
	ARMANDO 50/2 460x800x300	2576020 162.59
	<i>Skapis ar izlietni</i> ARMANDO 50/3 460x810x300	180.31
	ARMANDO 50/4 460x800x300	2576015 177.36
	<i>Skapis ar spoguļi</i> ARMANDO E50 500x600x220	2576011 84.24
	ARMANDO E60 600x600x220	2576022 91.64
	<i>Skapis ar spoguļi (stūra)</i> ARMANDO E40 400x730x230	2576012 79.82
	<i>Skapis ar izlietni (stūra)</i> ARMANDO 50/5 550(360)x810x380	2576017 203.96
	<i>Skapis ar izlietni</i> SAT 40 380x800x200	140.40
	<i>Skapis ar spoguļi</i> SALSA 50 500x600x150	2576025 110.84

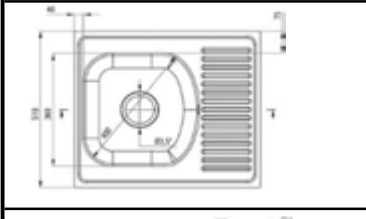
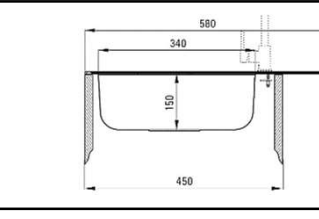
VIRTUVES IZLIETNES

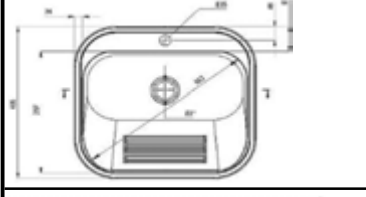
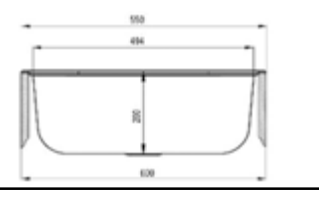
VEIKALS EUR

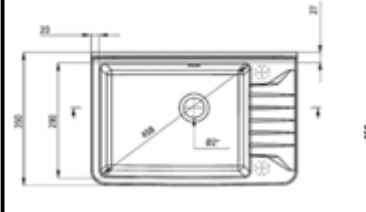
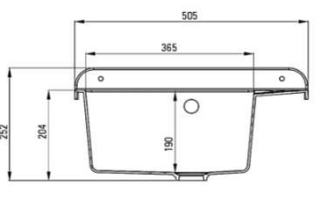
VEIKALS EUR

			<p><i>Virtuves izlietne DOPIO 780x430x160</i> Bez cauruma 57.20 8275125 Labā 57.20 8275150 Kreisā 57.20 8275152</p> <p><i>Komplektācija: Sifons un notece</i></p>
			<p><i>Virtuves izlietne LEGATO 780x435x160</i> Bez cauruma 57.20 8275126 Labā 60.95 8275149 Kreisā 60.95 8275151</p> <p><i>Komplektācija: Sifons un notece</i></p>
			<p><i>Virtuves izlietne ZQZ_N11A 580x440x164 granīta, melna</i> 8275124 122.20</p> <p><i>Komplektācija: Sifons un notece</i></p>
			<p><i>Virtuves izlietne ZEN_0103 480x430x175</i> 8275134 52.90</p> <p><i>Komplektācija: Sifons un notece</i></p>
			<p><i>Virtuves izlietne ZHC_0813 490x170</i> 8275135 60.95</p> <p><i>Komplektācija: Sifons un notece</i></p>
			<p><i>Virtuves izlietne ZPO_010B 550x505x200</i> 8275136 193.45</p> <p><i>Komplektācija: Sifons un notece</i></p>
			<p><i>Virtuves izlietne ZMU_0113 580x510x150</i> 8275137 56.90</p> <p><i>Komplektācija: Sifons un notece</i></p>
			<p><i>Izlietne saimnieciskā, metāla ZYK_010B 495x550x200</i> 8275138 138.00</p> <p><i>Komplektācija: Sifons un notece un stiprinājumi</i></p>
			<p><i>Izlietne saimnieciskā, polistirols ZYT_311A 505x341x252</i> 8275143 57.00</p> <p><i>Komplektācija: Sifons un notece un stiprinājumi</i></p>

VEIKALS

Izolācijas biezums mm	Čaulas iekšējais diametrs mm	Čaulas garums mm	Gabali iepakojumā	cena par gab
20	15	1 200	35	4.35
20	18	1 200	30	4.31
20	22	1 200	28	4.43
20	28	1 200	30	4.75
20	35	1 200	25	5.42
20	42	1 200	20	6.07
20	48	1 200	18	6.79
20	54	1 200	16	6.60
20	60	1 200	13	7.46
20	70	1 200	10	10.78
20	76	1 200	15	9.36
20	89	1 200	9	11.59

30	15	1 200	25	5.86
30	18	1 200	25	5.47
30	22	1 200	20	5.82
30	28	1 200	18	6.59
30	35	1 200	16	7.22
30	42	1 200	13	8.01
30	48	1 200	12	8.09
30	54	1 200	10	10.37
30	60	1 200	9	9.77
30	64	1 200	9	12.30
30	70	1 200	9	11.44
30	76	1 200	12	12.22
30	89	1 200	8	14.50
30	102	1 200	4	17.18
30	108	1 200	4	16.90
30	114	1 200	4	19.22
30	133	1 200	4	19.43
30	140	1 200	4	22.13
30	168	1 200	3	32.89
30	219	1 200	2	33.49
30	273	1 200	1	63.78

40	15	1 200	16	7.67
40	18	1 200	16	8.76
40	22	1 200	13	9.03
40	28	1 200	12	8.80
40	35	1 200	10	10.06
40	42	1 200	9	11.45
40	48	1 200	9	11.85
40	54	1 200	7	11.87
40	60	1 200	6	15.65
40	64	1 200	6	15.27
40	70	1 200	8	15.25
40	76	1 200	8	15.57
40	89	1 200	4	17.47
40	102	1 200	4	21.66
40	108	1 200	4	22.59
40	114	1 200	4	21.46
40	133	1 200	4	26.47
40	140	1 200	3	26.73
40	159	1 200	3	
40	168	1 200	3	35.94
40	219	1 200	2	41.76
40	273	1 200	1	84.62

50	15	1 200	10	10.94
50	18	1 200	9	10.75

Izolācijas biezums mm	Čaulas iekšējais diametrs mm	Čaulas garums mm	Gabali iepakojumā	cena par gab
50	22	1 200	9	12.22
50	28	1 200	9	11.60
50	35	1 200	7	13.73
50	42	1 200	6	13.72
50	48	1 200	8	15.53
50	54	1 200	8	15.12
50	60	1 200	5	15.26
50	64	1 200	4	20.06
50	70	1 200	4	19.41
50	76	1 200	4	21.62
50	89	1 200	4	21.72
50	102	1 200	4	26.45
50	108	1 200	4	25.24
50	114	1 200	4	27.23
50	133	1 200	3	37.26
50	140	1 200	3	38.79
50	159	1 200	3	
50	168	1 200	2	40.11
50	194	1 200	2	
50	219	1 200	1	50.32
50	273	1 200	1	108.80

60	22	1 200	6	14.85
60	28	1 200	8	16.38
60	35	1 200	8	16.12
60	42	1 200	4	18.87
60	48	1 200	4	18.61
60	54	1 200	4	20.90
60	60	1 200	4	21.30
60	64	1 200	4	22.45
60	70	1 200	4	25.41
60	76	1 200	8	23.90
60	89	1 200	4	26.39
60	102	1 200	3	30.69
60	108	1 200	3	39.84
60	114	1 200	3	38.04
60	133	1 200	3	36.81
60	140	1 200	3	40.44
60	159	1 200	2	
60	168	1 200	2	42.02
60	219	1 200	1	55.21
60	273	1 200	1	60.24

80	76	1 200	3	42.56
80	89	1 200	3	45.02
80	108	1 200	2	45.80
80	114	1 200	2	50.02
80	133	1 200	2	52.30
80	140	1 200	2	53.86
80	159	1 200	1	
80	168	1 200	1	60.95
80	219	1 200	1	74.56
80	273	1 200	1	81.51

100	108	1 200	1	65.11
100	114	1 200	1	64.26
100	133	1 200	1	74.24
100	140	1 200	1	71.07
100	159	1 200	1	
100	168	1 200	1	77.79
100	273	1 200	1	106.00





Ventilam ALU Lamella ML-3

Ventilam ALU Lamella ML-3

Deklarētā īpatnējā siltumvadītspēja	[W/(m·K)] 10°C - 0,039 50°C - 0,047 100°C - 0,060 150°C - 0,077
Maksimālā temperatūra	MST 50°C (EN 14706)
Ugunsdrošības klase	B-s1,d0 - nedegošs materiāls (EN 13501-1).
Biezumapielaides klase	T5
Iepakojums	Polietilēna maiss.

kods	Produkts	Biezums	Izmēri	m ² /paka	m ² palete	EUR/pck
Pašlīmējošs minerālvates lamellu paklājs, pārklāts ar alumīnija foliju un pašlīmējošu slāni						
56201	Ventilam ALU Lamella	20	12000/1000/20	12	288	97.03
56203	Ventilam ALU Lamella	30	8000/1000/30	8	240	81.03
	Ventilam ALU Lamella	40	6000/1000/40	6	240	71.90
56207	Ventilam ALU Lamella	50	5000/1000/50	5	180	63.98



Piegades laiks iepriekš saskaņojot
Piegades laiks iepriekš saskaņojot

Climcover Lamella ML-3

Climcover Lamella ML-3

Deklarētā īpatnējā siltumvadītspēja	[W/(m·K)] 0°C - 0,036 50°C - 0,044 100°C - 0,056 150°C - 0,072 200° - 0,091
Maksimālā temperatūra	MST 260°C (EN 14706)
Ugunsdrošības klase	A1 - nedegošs materiāls (EN 13501-1).
Biezumapielaides klase	T4
Ūdens tvaiku pretestības koef	μ~1 EN 12086
Hlorīda joni	CL < 10 mg/kg (EN 13468).
Iepakojums	Polietilēna maiss.
Sertifikāti	CE

kods	Produkts	Biezums	Izmēri	m ² /paka	m ² palete	Min EXW	EUR/pck
„G3 touch“ minerālvates lamellu paklājs, pārklāts ar alumīnija foliju. A1 klase							
56280	Climcover Lamella ML-3	20	10 000/1200/20	12	144	1 paka	91.68
56282	Climcover Lamella ML-3	30	8000/1200/30	9.6	115.12	1 paka	85.95
56284	Climcover Lamella ML-3	50	5000/1200/50	6	72	1 paka	75.15
56287	Climcover Lamella ML-3	80	3000/1200/80	3.6	43.2	1 palete	65.77
56289	Climcover Lamella ML-3	100	2500/1200/100	3	36	1 paka	66.24



Ultimate Protect Wired Mat Alu1 Black Cenrādis 2021

Ugunsdrošs Ultimate vates paklājs, cauršūts ar tērauda sietu, ar melnu alumīnija pārklājumu

Paredzēts ventilācijas konstrukciju ugunsizturības nodrošināšanai līdz EI -120 EN13501-2

Blīvums 66kg/m³

Maksimālā temperatūra MST 400°C (EN 14706)

Ugunsreakcijas klase A1 - nedegošs materiāls (EN 13501-1).

Iepakojums Polietilēna maiss.

Sertifikāti CE



kods	Produkts	Biezums mm	Izmēri	m ² /paka	m ² paleta	EUR/pck
Ultimate vates paklājs EI ugunsizturības nodrošināšanai						
84433	UPWM 4.0 ALU1 Black	30	30/600/10000	12	216	359.36
84434	UPWM 4.0 ALU1 Black	40	40/600/7500	9	162	323.42
84435	UPWM 4.0 ALU1 Black	50	50/600/6000	7.2	129	302.25
84436	UPWM 4.0 ALU1 Black	60	60/600/5000	6	108	287.65
84437	UPWM 4.0 ALU1 Black	70	70/600/4300	5.16	92.88	278.55
84438	UPWM 4.0 ALU1 Black	75	75/600/4000	4.8	86.4	273.49
84439	UPWM 4.0 ALU1 Black	80	80/600/3700	4.44	79.2	266.39
84440	UPWM 4.0 ALU1 Black	90	90/600/3300	3.96	71.28	261.31
84441	UPWM 4.0 ALU1 Black	100	100/600/3000	3.6	64.8	259.20
84442	UPWM 4.0 ALU1 Black	120	120/600/2500	3	54	251.86

Ultimate Protect Slab Alu1 Black Cenrādis 2021

Ugunsdrošas Ultimate vates loksnes

Paredzētas ventilācijas konstrukciju ugunsizturības nodrošināšanai līdz EI -120 EN13501-2

Blīvums 67,5kg/m³

Maksimālā temperatūra MST 400°C (EN 14706)

Ugunsreakcijas klase A1 - nedegošs materiāls (EN 13501-1).

Iepakojums Polietilēna maiss.

Sertifikāti CE

kods	Produkts	Biezums mm	Izmēri	m ² /paka	m ² paleta	EUR/pck
Ultimate Protect vates loksnes EI ugunsizturības nodrošināšanai						
84467	UPS 4.0 ALU1 Black	30	30/600/1200	9.36	112.32	187.45
84468	UPS 4.0 ALU1 Black	40	40/600/1200	7.2	86.4	183.90
84469	UPS 4.0 ALU1 Black	50	50/600/1200	5.76	69.12	179.12
84470	UPS 4.0 ALU1 Black	60	60/600/1200	4.32	51.84	159.95
84471	UPS 4.0 ALU1 Black	70	70/600/1200	3.6	43.2	153.94
84472	UPS 4.0 ALU1 Black	80	80/600/1200	3.6	43.2	171.96
84473	UPS 4.0 ALU1 Black	90	90/600/1200	2.88	34.56	155.17
84474	UPS 4.0 ALU1 Black	100	100/600/1200	2.88	34.56	169.57



AUGSTĀKĀ SILTINĀŠANAS KLASE





FIREPROTECT 150 cenrādis 2021

Stingras akmensvates loksnes, ugunsdrošības risinājumiem

Bļivums	20mm - 165kg/m ³ 30-100mm 150kg/m ³
Maksimālā temperatūra	MST 700°C (EN 14706)
Kušanas	≥ 1000°C
Ugunsreakcijas klase	A1 - nedegošs materiāls (EN 13501-1).
Biezumapielaides tolerance	± 1mm
Udensabsorbicija	WS ≤ 1 kg/m ² (EN 1609).
Hlorīda joni	CL < 10 mg/kg (EN 13468).
Siltumvadītspējas koeficients	[W/(m·K)] λ10 °C 0,036
Sertifikāti	EN 1365-2:2015 EN 13381-4:2013

FIREPROTECT 150



kods	Produkts	Biezums mm	Izmēri	m ² /paka	m ² paleta	EUR/pck
Akmensvates loksnes augstai termiskajai pretestībai un mehāniskajai slodei 20kPa SSG7591						
56169	FireProtect 150	20	20/600/1200	8.64	86.4	119.98
56179	FireProtect 150	30	30/600/1200	5.04	60.48	89.85
56178	FireProtect 150	50	50/600/1200	2.88	34.56	85.42
56177	FireProtect 150	60	60/600/1200	2.88	28.8	100.68
56174	FireProtect 150	100	100/600/1200	1.44	17.28	81.67

Climcover Roll CR Alu1

minerālvates paklājs, pārklāts ar pastiprinātu alumīnija foliju,

Deklarētā īpatnējā siltumvadītspēja	[W/(m·K)]	10°C - 0,036 50°C - 0,043 100°C - 0,054
Maksimālā temperatūra	MST 150°C	
Ugunsdrošības klase	A1 30-100mm; 20mm A2-s1,d0 - nedegošs materiāls (EN 13501-1).	
Iepakojums	Polietilēna maiss.	

CLIMCOVER CR1/CR 2 ALU 2



kods	Produkts	Biezums mm	Izmēri	m ² /paka	m ² paleta	EUR/pck
Minerālvates paklājs ar pastiprinātu alumīnija pārklājumu, ventilācijas, tvertņu un dažādu virsmu izolēšanai.						
25263	Climcover Roll CR Alu2	20	10000/1200/20	12	n/p	65.06
25274	Climcover Roll CR Alu1	30	8000/1200/40	9.6	n/p	60.00
25309	Climcover Roll CR Alu1	50	7000/1200/50	8.4	n/p	59.85
25408	Climcover Roll CR Alu1	80	5500/1200/60	6.6	n/p	67.81
25444	Climcover Roll CR Alu1	100	4000/1200/70	4.8	n/p	61.14

Climliner Slab V2 (ex KVL)

Stingras stiklavates loksnes ar melnu filcēcu stiklašķiedras pārklājumu

Paredzētas ventilācijas konstrukciju akustiskajai un siltumizolācijai

Deklarētā īpatnējā siltumvadītspēja	[W/(m·K)]	10°C - 0,032 50°C - 0,037 100°C - 0,047
Skaņas absorbicija	α w 15 mm: 0.45; 30 mm 0.70; 50 mm: 1.00; 100 mm: 1.00	
Ugunsreakcijas klase	A2 (s1; d0) nedegošs materiāls (EN 13501-1).	
Iepakojums	Polietilēna maiss.	
Biezumapielaides klase	T3	
Maksimālā servisa temperatūra	150°C	

CLIMLINER SLAB V1, V2 pārklātas ar stiklašķiedras audumu



kods	Produkts	Biezums mm	Izmēri	m ² /paka	m ² paleta	EUR/pck
ISOVER Climliner Slab V2						
50645	Climliner Slab V2	15	15/1200/1200	14.4	216	105.35
50671	Climliner Slab V2	30	30/1200/1200	8.64	86.4	88.37
30102	Climliner Slab V2	50	50/1200/1200	5.76	57.6	89.34
31133	Climliner Slab V2	100	100/1200/1200	2.88	28.8	73.02
30115	Climliner Slab V2	50	50/1200/3000	6.48	129.60	104.31
30156	Climliner Slab V2	100	100/1200/2400	10.368	103.68	167.16



AUGSTĀKĀ SILTINĀŠANAS KLAŠE





EUR
VEIKALS

INSTRUMENTI



EUR
VEIKALS

921 PPR 733 Šķēres PPR caurulēm 0-42mm, nerūsējošā tērauda asmenis, ar gumiju

14.73 3435001



913- PLAKANS NEW

Lodāmurs 800W (komplektā ar uzgaļiem 20-63mm)
Darba t° +50 LĪDZ + 300; jauda- 800W; 220V. Metāla kaste

55.08

7635018



921 PPR 734 Šķēres PPR caurulēm 0-42mm, nerūsējošā tērauda asmenis

14.46 3435002



Cauruļu kalibrētājs
16-20
11.45 6435005



913- APAĻŠ

Lodāmurs 1200W (komplektā ar uzgaļiem 16-32mm) Darba t° + 265; jauda- 1200W; 220V. Metāla kaste 47x43x32cm

78.45 7635014



Apalā lodāmura uzgaļi
20; 25; 32

8.24 9735006
9.00 9735007
9.81 9735008



922 MINI griezējs caurulēm, 3-22mm

5.95 3435003



923 Cauruļu

9.06 3435004



924 Cauruļu grizējs, 6-50mm

17.44 3435005



1450023 Katlu birste (plakana)

5.83 8235001



331184 PE cauruļu gala frēze

20-63 mm

19.06 2535030



913- PLAKANS Lodāmurs 1000W (komplektā ar uzgaļiem 20-63mm) GF-825X. Darba t° + 265; jauda- 1000W; 220V. Metāla kaste 47x43x32cm

69.91 7635001



913- APAĻŠ Lodāmurs 800W (komplektā ar uzgaļiem 16-32mm), GF-834. Darba t° + 265; jauda- 800W; 220V. Metāla kaste 47x43x32cm

73.61 7635020



VEIKALS EUR

<i>Cirkulācijas sūkņi</i>			
Mehāniskais, trīs ātrumi			
		"OHI"	
	OHI 15-60 / 130 bronzas korpus	80.68	7928033
	OHI 15-60 / 130	55.44	7928030
	OHI 25-40 / 180	46.10	7928020
	OHI 25-60 / 130	56.28	7928031
	OHI 25-60 / 130 bronzas korpus	82.80	7928034
	OHI 25-60 / 180	51.41	7928021
	OHI 25-80 / 180	98.76	7928029
	OHI 32-60 / 180	61.21	7928027
	OHI 32-80 / 180	111.75	7928028
Uz pasūtījumu	OHI 40- 80 / 200	141.65	
Uz pasūtījumu	OHI 50-140/220	278.15	
Uz pasūtījumu	OHI 50-170/250	371.78	

VEIKALS EUR

<i>Cirkulācijas sūkņi</i>			
Elektroniskais, "A" klase			
		"MAGI 2"	
	25-40/180 + fittings	147.53	7928047
	25-60/180 + fittings	158.73	7928043
<i>Karstā ūdens cirkulācijas sūkņi</i>			
	CPI 15-15	82.58	7928022
<i>Karstā ūdens cirkulācijas sūkņi</i>			
	E-IBO 15-14	133.92	7928044
<i>Savienojuma komplekts sūkņiem</i>			
	1"	4.11	2124172
	1.1/4"	5.25	2124173
112300	<i>Savienojuma komplekts sūkņiem</i>		
	1"	4.25	0925308
<i>Vibrosūkņi</i>			
		"NEMO VM60"	
	VM60 - 3	46.62	7928050

VEIKALS EUR



Ūdens sūknis RUCESUK-1
34.74 2328003

Sūkņa dati:
 Maksimālais spiediens 6,0 m
 Maksimālā ražība 1,5 m³/h
 Sūkņa diametrs 100 mm
 Sūkņa garums 290 mm
 Sūkņa svars 3,9 kg
 Parsūkņejamā ūdens maksimālā temperatūra +35 °C

Elektriskie dati:
 Vienfāzu maiņstrāvas spriegums 220V
 Pieļaujamās tīkla sprieguma atkāpes no nomināla ±10 %
 Tīkla frekvence 50 Hz
 Elektrodzinēja jauda 0,225 kW
 Strāvas stiprums 1,0 A
 Elektriskā kabeļa garums 10 metri

VEIKALS EUR



Iegremdējamais sūknis QDVX 16000
118.52 2328018

Sūkņa dati:
 Maksimālais spiediens 7,0 m
 Maksimālais ražīgums (267 l/min) 16 m³/h
 Sūkņa augstums 36 cm
 Sūkņa diametrs 17 cm
 Sūkņa svars 6,0 kg

Elektriskie dati:
 Elektrodzinēja absorbētā jauda P1= 0,6 kW
 Elektrodzinēja nominālā jauda P2=0,37 kW
 Vienfāzu maiņstrāvas spriegums 230 V
 Pieļaujamās tīkla sprieguma atkāpes no nomināla ±5 %
 Tīkla frekvence 50 Hz
 Strāvas stiprums 2,7 A
 Elektriskā kabeļa garums 10 metri

Iegremdējamais sūknis QDV 8000



59.25 2328016

Sūkņa dati:
 Maksimālais spiediens 5,0 m
 Sūkņa augstums 30 cm
 Sūkņa diametrs 17 cm
 Sūkņa svars 3,9 kg
 Maksimālais ražīgums (130 l/min) 7,8 m³/h

Elektriskie dati:
 Elektrodzinēja absorbētā jauda P1=0,32 kW
 Elektrodzinēja nominālā jauda P2=0,21 kW
 Vienfāzu maiņstrāvas spriegums 230 V
 Pieļaujamās tīkla sprieguma atkāpes no nomināla ±5 %
 Tīkla frekvence 50 Hz
 Strāvas stiprums 1,5 A
 Elektriskā kabeļa garums 10 metri

Ūdens apgādes automāts



WP INOX - 1000 24H
202.00 2328019

Pielietojuma ierobežojumi:
 Maksimālā sūkņejamā ūdens temperatūra +35°C,
 Aizliegts sūkņēt jūras ūdeni, kā arī ķīmiski agresīvus un sprādzienbīstamus šķidrumus.
 Sūkņi nedrīkst darbināt tukšgaitā bez ūdens.
 Sūkņis jāsarģā no sala.

Elektriskie dati:
 Elektrodzinēja absorbētā jauda 0,80 kW
 Elektrodzinēja nominālā jauda 0,55 kW
 Vienfāzu maiņstrāvas spriegums 230V/50 Hz
 Aizsardzības klase IP44

Iegremdējamais sūknis QDV 14000



76.40 2328017

Sūkņa dati:
 Maksimālais spiediens 7,0 m
 Sūkņa augstums 33 cm
 Sūkņa diametrs 17 cm
 Sūkņa svars 4,5 kg
 Maksimālais ražīgums (230 l/min) 14 m³/h

Elektriskie dati:
 Elektrodzinēja absorbētā jauda P1= 0,6 kW
 Elektrodzinēja nominālā jauda P2=0,37 kW
 Vienfāzu maiņstrāvas spriegums 230 V
 Pieļaujamās tīkla sprieguma atkāpes no nomināla ±5 %
 Tīkla frekvence 50 Hz
 Strāvas stiprums 2,7 A
 Elektriskā kabeļa garums 10 metri

Sūkņa dati:

Maksimālā ražība 55 l/min.
 Maksimālais spiediens 46 m
 Maksimālais uzsūkšanas augstums 8 m
 Sūkņa pievienošanas vītņu izmēri 1”
 Svārs 12,2 kg

VEIKALS EUR

VEIKALS EUR

Ūdens sūknis JSWm 1BN



247.15	7928001
iesūkšanas augstums ,m	9
Spriegums ,V	220
Jauda ,kW	0.5
Maks. ražība l/min	55
Darba spiediens BAR	1,4 - 2,8

Ūdens sūknis JSWm 2CX



269.36	7928002
iesūkšanas augstums ,m	9
Spriegums ,V	220
Jauda ,kW	0.75
Maks. ražība l/min	70
Maks. Spiediens m	47

Ūdens sūknis JSWm 2AX



306.85	7928003
iesūkšanas augstums ,m	9
Spriegums ,V	220
Jauda ,kW	1.1
Maks. ražība l/min	70
Maks. Spiediens m	47

Ūdenssūknis - automāts JSWM 1BN-24CL



291.58	7928004
iesūkšanas augstums ,m	9
Spriegums ,V	220
Jauda ,kW	0.5
Maks. ražība l/min	55
Darba spiediens BAR	1,4 - 2,8

Ūdenssūknis - automāts JSWM 2CX-24CL



342.95	7928005
augstums ,m	9
Spriegums ,V	220
Jauda ,kW	0.75
l/min	70
spiediens	1,4 - 2,8

Ūdenssūknis - automāts JSWM 2AX-24CL



392.94	7928006
iesūkšanas augstums ,m	9
Spriegums ,V	220
Jauda ,kW	1.1
Maks. ražība l/min	70
Darba spiediens BAR	2,5 - 4,0

Membrāna izplešanās traukam



24 L (80)	15.27	7928007
35/50 L (80)	31.24	7928012
60/80L (80)	47.21	7928015

Misīņa trejgabals 1"(F-F-M) sūkņiem



6510G		
1/2"	3.00	0925278
3/4"	4.58	0925279
1"	9.72	0925319

Spiediena releji



FSG SQUARE-D	5,4-7,0bar
ar bezūdens aizsardzību	
39.57	7928008



PM/5 ITALTECNICA	1,4-2,8bar
15.98	7928009

Nosaukums	Tilpums L	Art.	Jauda W	Izmēri augst.x plat.x d. mm	Sasildīš. laiks līdz 65°C (Δ50°C)	VEIKALS
-----------	--------------	------	------------	-----------------------------------	--------------------------------------	---------



- 1) Elektroniskais termometers
- 2) Oļeņķaī graudņu zona
- 3) Pārsluobi stādņāi kārķu iz keramikānāi stādņāi
- 4) Magnētiānāi anods
- 5) Sūsiāi inātrānāi sūsiāi ānāi et ānāi
- 6) Kārķuāi rāfānāi
- 7) Inātrānāi rāfānāi
- 8) Inātrānāi rāfānāi rāfānāi
- 9) Inātrānāi rāfānāi rāfānāi
- 10) Inātrānāi rāfānāi rāfānāi
- 11) Inātrānāi rāfānāi rāfānāi
- 12) Inātrānāi rāfānāi rāfānāi



EXPERT - Sērija

5 gadu garantija tvertnei, 2 gadu garantija elektronikai

Ārējais termometers, cirkonija pārklājums, nerūsējoša izolējoša caurule, magnija anods, augstsprieguma sildelements, ūdens padeves difuzors, "PRO" sistēma, lielblīvuma poliuretāna izolācija 0% CFC, ārējais termoregulators, dielektrisks savienotājs, termostats

Virs izlietnes	10	3000	1600	456 x 255 x 262	24min.	118.69
	15	3001	2000	399 x 338 x 345	35min.	133.10
Zem izlietnes	10	3012	1600	456 x 255 x 262	19min.	120.88
	15	3013	2000	399 x 338 x 345	23min.	133.10
Vertikālie	30	3002	2000	623 x 338 x 345	57 min	144.23
	50	3003	2000	585 x 433 x 451	1st.18 min	169.79
	50	30020	1500	Clacic O'Pro		167.79
	80	3004	2000	814 x 433 x 451	2st.20 min	198.82
	100	3005	2000	973 x 433 x 451	2st.48 min	214.46
	150	3008	1650	505 x 520 x 1241	4st.36 min	321.25
	200	3009	2000	505 x 520 x 1568	5st.50 min	430.15
Horizontāls	80	3006	1500	580 x 809 x 451	2st.38 min	198.31
	100	3007	1500	580 x 968 x 451	3st.36 min	218.43
Grīdas, vertikālais	300	3010	3000	570 x 640 x 1765	5st.33 min	827.61
	500	3011	6000	750 x 850 x 1840	4st.41 min	2058.17

Sērija STEATITE PRO

5 gadu garantija tvertnei, 2 gadu garantija elektronikai

Ārējais termometers, cirkonija pārklājums, nerūsējoša izejošā caurule, magnija anods, "steatite" keramiskais (sausais) sildelements, ūdens padeves difuzors, emaljēta bāka, lielblīvuma poliuretāna izolācija 0% CFC, ārējais termoregulators, dielektrisks savienotājs, termostats

Vertikālie	50	3020	2100	613 x 433 x 451	1st.22 min	244.16
	80	3021	2100	860 x 433 x 451	2st.12 min	272.30
	100	3022	2100	1022 x 433 x 451	2st.48 min	288.98
	150	3023	1800	505 x 1241	4st.36 min	421.20
	200	3024	2400	505 x 1568	5st.50 min	489.05
Horizontāls	150	3014	2200	1185 x 530	4st.20 min	470.45
	200	3015	2200	1490 x 530	5st.40 min	531.85
Vertikālie grīdas 230/380 V	200	3025	2400	1258 x 575	4st.45 min	1045.65
	300	3026	3000	1761 x 575	5st.46 min	1094.43

Nosaukums	Tilpums L	Art.	Jauda W	Izmēri augst.x plat.x d. mm	Sasildīš. laiks līdz 60°C (Δ50°C)	Sasildīš. laiks ar "BOAST"	VEIKALS
Sērija VERTIGO							
5 gadu garantija tvertnei, 2 gadu garantija elektronikai							
<i>Cirkonija pārklājums tvertnei, nerūsējoša izejošā caurule, "Steatite" keramiskais (sausais) sildelements ar magnija anodu, ūdens padeves difuzors, digitālais displejs, lielblīvuma poliuretāna izolācija 0% CFC</i>							
<i>SMART CONTROL - ieraksta patērētāju ieradumus vienas nedēļas laikā sekojot temperatūrai. Panākot pienācīgu, līdzsvarotu enerģijas taupīšanu.</i>							
<i>SMART CONTROL - ieslēgšanas indikators, ātrā uzsildīšana, "SMART" dušas displejs, manuālais režīms, pretsasalšanas režīms (7°C), manuālā temperatūras regulēšana, "SMART" režīms, režīmu regulators</i>							
Vertikāls / horizontāls	25	3084	1500 + 750	610 x 490 x 290	46 min	30 min	343.02
	40	3081	1500 + 750	765 x 490 x 290	49 min	30 min	392.04
	65	3082	1500 + 750	1090 x 490 x 290	1 st. 19 min.	30 min	532.32
	80	3083	1500 + 750	1300 x 490 x 290	1 st. 38 min.	30 min	557.14





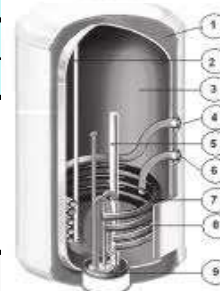

















Kombinētie COMBI OPro							
5 gadu garantija tvertnei, 2 gadu garantija elektronikai							
<i>Ārējais termometrs, cirkonija pārklājums, nerūsējoša izejošā caurule, magnija anods, sildelements, ūdens padeves difuzors, O'PRO - pasīvā korpusa aizsardzība, lielblīvuma poliuretāna izolācija 0% CFC, ārējais termoregulators, dielektriskais savienotājs, termostats</i>							
Nosaukums	Tilpums L	Art.	Jauda W	Izmēri mm	Siltummaiņa jauda kW	Ražīgums l/st ***	VEIKALS
Kombinētais	80	3030	1500	451 x 860	12 - 17.5	431	267.85
	100	3031	1500	451 x 1022	12 - 17.5	431	289.61



DUOTHERM							
5 gadu garantija tvertnei, 2 gadu garantija elektronikai							
<i>Koniska siltummaiņa, cirkonija pārklājums, lielblīvuma poliuretāna izolācija 0% CFC (6 cm), nerūsējoša izejošā caurule, ūdens padeves difuzors</i>							
Nosaukums	Tilpums L	Art.	Jauda W	Izmēri mm	Siltummaiņa jauda kW	Ražīgums l/st ***	VEIKALS
Universāls bez elektriska sildelementa	100	3032		567 x 747	11.9 - 18.0	290-444	425.33
	150	3033	2200	567 x 1002	17.5 - 26.0	426-642	649.04
	200	3034	2200	567 x 1257	19.2 - 29.0	468-708	686.06

























Parametri: 90/10/45°C (siltumnesēja temperatūra/temperatūra pie izejas/temperatūra pie ieejas), siltummaiņa ražīgums - 2.0 m3/st

	VEIKALS	EUR		VEIKALS	EUR	
3200 00	Magnija anods M5 21.3x110	8.30	3768100	3209 00	Magnija anods M6 25.5 x 230	12.56 3768110
	SC/PRO 10-15-30				SG/TI/ PRO R/ 50-80-100	
3201 00	Magnija anods M8 21.3x660	25.12	3768101	3215 00	Sildelements 1200W	33.04 3768112
	SG/ 150				SG 100-100-120HT	
3202 00	Magnija anods M8 21.3x1000	37.71		3217 00	Sildelements 2.5 kW	32.89 3768309
	SG/ 200				SG200	
3203 00	Magnija anods M8 21.3x550	21.37		3220 00	Sildelements 1.5 kW ar flanci	30.15 3768310
	BDR 100-150				SG/PRO R/ 10-15-30	
3204 00	Magnija anods M4 16 x 210	11.01	3768104	3221 00	Sildelements 1800W	49.94 3768118
	SG/PRO/TI 30				PRO R/ PRO ECO 50-80-100	
3205 00	Magnija anods M8 21.3 x 350	19.54	3768312	3222 00	Sildelements 1800W	47.74 3768120
	TI				PRO R/ PRO ECO 50-80-100H	
3206 00	Magnija anods M4 13.8 x 150	4.46	3768106	3223 00	Sildelements 1500W	21.40 3768120
	SG/PRO/ 10-15				SG 80-100	
3208 00	Magnija anods M5 25.5 x 230	12.56	3768108	3224 00	Sildelements 1.0 kW ar flanci	45.23 3768100
	SG/TI/ PRO R/ 50-80-100				VLS 50-80-100	
3275 00	Magnija anods M6, ar kātu 21x290 (21x110)	8.12	3768109	3225 00	Sildelements 1.5 kW ar flanci	45.23 3768100
	SG/TI/ PRO R/PRO ECO 50-80-100				VLS 50-80-100	
				3226 00	Sildelements 2.2 kW ar flanci	42.71 3768100
					SG/TI 150	
				3227 00	Sildelements 2.5 kW ar flanci	56.54 3768100
					SG/TI 200	

REZERVES DAĻAS BOILERIEM

	VEIKALS	EUR		VEIKALS	EUR	
3233 00			<i>Sildelements</i>	3251 00		<i>Termoregulators</i>
1200W	21.36	3768130	SG 50-80		18.93	3768147
				SG/PRO R 80-100/80H-100H		
3234 00			<i>Sildelements</i>	3252 00		<i>Termoregulators</i>
1500W	21.36	3768131	SG 100		18.84	3768148
				SG/PRO R/BDRM 80-100-120		
3235 00			<i>Sildelements</i>	3253 00		<i>Termoregulators</i>
1200W	28.47	3768132	SG 80H		46.48	
				SG 10-15		
3236 00			<i>Sildelements</i>	3254 00		<i>Termoregulators</i>
2000W	23.86	3768134	SG 120/ TI 120L		23.88	
				BDR 150-200		
3238 00			<i>Sildelements</i>	3255 00		<i>Termoregulators</i>
2000W	25.12	3768136	SG 80-100TDX		20.11	
				SG 30		
3244 00			<i>Elektronisks termostats</i>	3256 00		<i>Termoregulators</i>
	61.57		PRO ECO 50-80-100		44.87	3768152
				SG/TI 120-200		
3245 00			<i>Elektronisks termostats</i>	3258 00		<i>Termoregulators</i>
	64.08		PRO ECO 50-80-100H		23.88	
				SG/TI 120		
3246 00			<i>Termostats</i>			
			TI SHAPE 50-80-100			
3250 00			<i>Termoregulators</i>			
	18.95	3768314	SG/BDRM 50-80-100			

	VEIKALS	EUR	
	3260 00	23.86	Termoregulators TI SHAPE 50-80-100 3768156
	3261 00	5.01	Blīve flancim BDR/TI 50-100 3768157
	3262 00	5.14	Blīve flancim SG/PRO R/TI 150-200 3768158
	3263 00	3.77	Blīve flancim SG/PRO 10-15-30 3768159
	3264 00	12.76	Flancis ar blīvi SG/PRO R/TI 50-80-100 3768160
	3265 00	7.53	Blīve flancim VLS 50-80-100 3768161
	3274 00	5.62	Blīve flancim PRO R, BLU R PRO ECO (no2013.gada) 3768162
	3299 00 0	1.40	Blīve sildelementam ar vītņi 1800 3766001
	3303 00	1.40	Blīve sildelementam, DUOTHERM VM050-80-100/DUOTHERM/PC10-15-30 (40146) 3766000
	3256 00	33.93	Vadības bloks VLS 50-80-100 3768155
	3267 00	110.58	Vadības bloks VLS PREMIUM/PLUS 50-80-100 3768156
	3268 00	65.34	Barošanas bloks VLS/VLS PREMIUM/PLUS 3768157
	3269 00	23.88	Termometrs 3768158
	3270 00	11.93	Termometrs 3768167
	3272 00	9.43	Signāla lampiņa 3768168

	VEIKALS	EUR	
	3273 00	15.08	Signāla lampiņa 3768169
SILDELEMENTI AR VĪTNI 1.1/4"			
	32931 00	3000kW 22.61	Sildelements (Itālija) 3768175
	3294 00	1200W 17.58	Sildelements (Itālija) 3768176
	3295 00	1500W 17.58	Sildelements (Itālija) 3768177
	3296 00	2000W 17.58	Sildelements (Itālija) 3768178
	3297 00	1200W 17.58	Sildelements (Itālija) 3768179
	3298 00	1500W 17.58	Sildelements (Itālija) 3768180
	3299 00	2000W 16.49	Sildelements (Itālija) 3768181

GAB. EUR VEIKALS

GAB. EUR VEIKALS

SNAP		<i>Nerūsējošā tērauda remontskava</i>	
	21-25 (60)	11.53	
	26-30 (60)	11.40	
	33-37 (60)	12.09	
	42-45 (60)	12.30	
	48-51 (60)	13.06	2521047
	55-58(60)	13.70	2521048
	60-64 (60)	13.73	2521049

RS-1		<i>Nerūsējošā tērauda remontskava</i>	
	60-67 (150)	86.17	
	70-77 (150)	87.49	
	76-85 (150)	87.20	
	87-95 (150)	88.34	
	108-118 (150)	97.25	
	159-170 (150)	108.14	
	76-85 (200)	95.88	
	87-95 (200)	96.90	
	95-105 (200)	98.02	
	108-118 (200)	109.16	2527000
	113-123 (200)	109.26	
	159-170 (200)	123.59	
	108-118 (300)	164.33	
	113-123 (300)	166.04	
	159-170 (300)	187.44	

RS-2		<i>Nerūsējošā tērauda remontskava</i>	
	108-128 (200)	167.65	
	158-180 (200)	203.79	
	108-128 (300)	258.36	

3100GE		<i>Bezvītnes pāreja tērauda caurulei</i>	
	1/2"	18	8.80 2521003
	3/4"	18	11.60 2521004
	1"	15	13.95 2521005
	1,1/4"		18.64 2521006
	1,1/2"	8	22.39 2521007
	2"	6	32.84 2521008

3101GE		<i>Bezvītnes pāreja tērauda caurulei</i>	
	1/2"	18	10.06 2521009
	3/4"		11.24 2521010
	1"	15	14.05 2521011
	1,1/4"	10	19.13 2521012
	1,1/2"	8	22.83 2521013
	2"	6	33.80 2521014

3102GE		<i>Bezvītnes uzdeva tērauda caurulei</i>	
	1/2"	18	14.17 2521015
	3/4"	15	17.23 2521016
	1"	15	22.56 2521017
	1,1/4"	10	30.23 2521018
	1,1/2"	8	33.12 2521019
	2"	6	48.54 2521020

3103GE		<i>Bezvītnes trejgabals tērauda caurulei</i>	
	1/2"	18	15.18 2521021
	3/4"	15	20.26 2521022
	1"	15	25.10 2521023
	1,1/4"	10	35.77 2521024
	1,1/2"	8	37.39 2521025
	2"	6	55.10 2521026

3104GE		<i>Bezvītnes remontskava ar atzaru tērauda caurulei</i>	
	1/2"x1/2"	15	9.17 2521037
	3/4"x1/2"	15	10.18 2521038
	1"x1/2"	15	12.12 2521039
	1"x3/4"	15	12.12 2521040
	1,1/4"x3/4"	8	15.97 2521041
	1,1/2"x3/4"	6	18.89 2521042
	2"x1"	4	27.68 2521043

3105GE		<i>Bezvītnes remontskava tērauda caurulei</i>	
	1/2"	18	6.88 2521028
	3/4"	18	7.74 2521029
	1"	8	9.85 2521030
	1,1/4"	10	12.55 2521031
	1,1/2"	6	17.22 2521032
	2"	6	24.22 2521033

GARUMS 3 M		<i>Tērauda caurule, melna</i>	
	DN15(21.3x2.6)	5.24	2532008
	DN20(26.9x2.6)	6.24	2532009
	DN25(33.7x3.2)	11.00	2532010
	DN32(42.3x3.2)	13.61	2532020
	DN40(48.3x3.2)	15.74	2532012
	DN50(60.3x3.2)	19.66	2532013
	DN65(76.1x3.2)	22.71	2532023

GARUMS 3 M		<i>Tērauda caurule, cinkota</i>	
	DN15(21.3x2.6)	5.73	2532025
	DN20(26.9x2.6)	8.21	2532016
	DN25(33.7x3.2)	11.49	2532014
	DN32(42.3x3.2)	13.95	2532015
	DN40(48.3x3.2)	16.86	2532021
	DN50(60.3x3.2)	21.62	2532022



Jauda W	Garums m	80W/m2 papildus	110W/m2 telpas	150W/m2 van. ist.		
160	8.3	2.0	1.5	1.0	35.41	8238015
270	14	3.2	2.4	1.7	48.89	8238016
340	17.2	4.0	2.9	2.1	56.44	8238017
450	22.5	5.2	3.8	2.8	68.26	8238018
540	27.4	6.5	4.7	3.5	74.15	8238019
640	32.1	7.5	5.5	4.0	86.63	8238020
720	35.8	8.5	6.2	4.5	96.80	8238021
870	43.8	10.3	7.5	5.5	110.92	8238022
1070	53.5	12.5	9.1	6.6	120.10	8238023
1290	64.4	15.0	10.9	8.0	136.19	8238024
1580	79	18.7	13.6	10.0	157.19	8238025
1850	92.4	21.2	15.4	11.3	168.14	8238026
2300	117.3	27.5	20.0	14.5	217.18	8238027
2750	141.4	32.5	23.6	17.3	275.24	8238028



Ekranizēts divdāzīslu kabelis ADSV+, 20 W/m, ar UV izturīgu apvalku

Apsildes paklāji LDTS – 160W/m2
solis - 7,6 cm, platums - 50cm
kabelis ADSV(3,6-4,8 mm) divdāzīslu.

Tips	Jauda W	Garums m	lekl.plat. m ²		
12070-165	70	0.9	0.5	34.38	8238029
12130-165	130	1.6	0.8	38.74	8238030
12210-165	210	2.6	1.3	54.33	8238031
12260-165	260	3.2	1.6	65.67	8238032
12340-165	340	4.2	2.1	82.13	8238033
12410-165	410	5.2	2.6	90.22	8238034
12500-165	500	6.1	3.0	107.86	8238035
12560-165	560	6.7	3.4	116.63	8238036
12670-165	670	8.3	4.2	142.88	8238037
12810-165	810	10.2	5.1	162.71	8238038
121000-165	1000	12.3	6.1	203.31	8238039
121210-165	1210	15.1	7.6	242.36	8238040
121400-165	1400	17.6	8.8	245.15	8238041
121800-165	1800	22.0	11.0	295.36	8238042
122150-165	2150	26.6	13.3	371.29	8238043
122600-165	2600	32.5	16.3	481.62	8238044

Termoregulatori	Jauda(W)	Slodze (A)	Sensors		
UFC 004, analogais	3600	16	Grīdas	38.36	8268004
UFC 001, program.	3600	16	Grīd/Telp	64.44	8268005
UFC E91, progr.skarienjūtīgs	3600	16	Grīd/Telp	82.85	8268006
BEOK 70 EP M/B, progr.skarienjūtīgs	3600	16	Grīd/Telp	138.39	8268007

Piederumi	Gar. (m)	Plat.(m2)		
Montāžas lenta GRUFAST 10m	10	4--5	30.43	8266002
Gofr.caurule sensora ievietošanai 16mm/2m	2		2.52	8238045

Paredzēti ūdensvadu apsildei, kā arī sniega un ledus kausēšanai tehnēs un notekās. Pašregulējošie kabeļi lietojami bez termoregulātora.

Tips	Nosaukums	Garums m	Jauda W	MAGMA KATALOGS	
FSM/ELSR	Pašregulējošais apsildes kabelis 11W/m, komplekts kontakt dakšu, 2m	2	22	51.75	8238001
FSM/ELSR	Pašregulējošais apsildes kabelis 11W/m, komplekts kontakt dakšu, 3m	3	33	64.82	8238002
FSM/ELSR	Pašregulējošais apsildes kabelis 11W/m, komplekts kontakt dakšu, 4m	4	44	77.84	8238003
FSM/ELSR	Pašregulējošais apsildes kabelis 11W/m, komplekts kontakt dakšu, 5m	5	55	90.25	8238004
FSM/ELSR	Pašregulējošais apsildes kabelis 11W/m, komplekts kontakt dakšu, 6m	6	66	103.94	8238005
FSM/ELSR	Pašregulējošais apsildes kabelis 11W/m, komplekts kontakt dakšu, 7m	7	77	116.98	8238006
FSM/ELSR	Pašregulējošais apsildes kabelis 11W/m, komplekts kontakt dakšu, 8m	8	88	130.03	8238007
FSM/ELSR	Pašregulējošais apsildes kabelis 11W/m, komplekts kontakt dakšu, 9m	9	99	143.08	8238008
FSM/ELSR	Pašregulējošais apsildes kabelis 11W/m, komplekts kontakt dakšu, 10m	10	110	156.12	8238009
FSM/ELSR	Pašregulējošais apsildes kabelis 11W/m, komplekts kontakt dakšu, 11m	11	121	169.16	8238010
FSM/ELSR	Pašregulējošais apsildes kabelis 11W/m, komplekts kontakt dakšu, 12m	12	132	182.21	8238011
FSM/ELSR	Pašregulējošais apsildes kabelis 11W/m, spolē metros	--	--	13.05	8238012
	Auksto galu montāža ar materiāliem, 1,5m + kontaktdakša	--	--	25.66	8238013
19805366	Pārejas blīvējums ar vītņi 3/4" un 1" , kabeļa ievadīšanai caurulē DEVI	--	--	31.77	8238014

Spoguļu apsildes elementi ECOFILM

Tips	Izmērs (mm)	Jauda W	Spriegums V	MAGMA	
MHF 12	274X274	12.5	230	15.14	8279011
MHF 25	274X574	25	230	27.52	8279012
MHF 50	524X524	50	230	38.37	8279013
MHF 100	1024X524	100	230	68.67	8279014

Pašlīmējoša apsildes folija, kas novērš spoguļa svīšanu un nodrošina skaidru redzamību telpās ar paaugstinātu mitrumu.

Vienkārša uzstādīšana - pielīmējiet spoguļa aizmugurē un pievienojiet pie strāvas (rekomendējam pie gaismas slēdža, lai ieslēdzoties gaismai tiek ieslēgta folija).

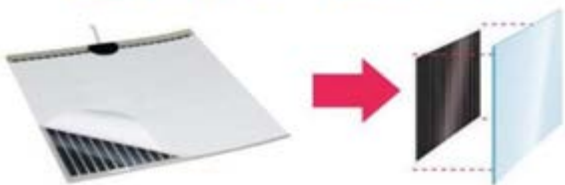

EUR
VEIKALS

Roratslēga VIRAX (vanadium)

10434	30.80	1"	2035002
10449	38.75	1.1/2"	2035003
10460	56.07	2"	2035004



Universālas knaibles VANADIX VIRAX

10924	13.96	240	2035005
10930	16.13	300	2035006



Knaibles VIRAX

18212	29.17	180	2035007
18218	31.57	250	2035008



LOCK knaibles VIRAX

18222	37.42	180	2035009
18228	44.36	250	2035010



Kapara cauruļu griezējs VIRAX

210441	27.38	C 28	2035011
--------	-------	------	---------



Kapara cauruļu griezējs VIRAX

210443	44.03	ZR35	2035012
--------	-------	------	---------

EUR
VEIKALS

NT cauruļu griezējs VIRAX

210475	73.63	C54	2035013
--------	-------	-----	---------



Plastmasas cauruļu griezējs VIRAX

215032	26.10	PC32	2035014
--------	-------	------	---------



PVC, PE, PER, PEX caurulēm

~~PPR~~

Plastmasas cauruļu griezējs VIRAX

215042	64.15	PC42	2035015
--------	-------	------	---------

PPR; CPVC; PEHD; ABS; PB caurulēm



Cauruļu griezējs VIRAX MINI

210439	23.47	28 mm	2035042
--------	-------	-------	---------

Vara caurulei no 3-28 mm



Plastmasas cauruļu griezējs

211464	148.57	D63 mm	2035054
--------	--------	--------	---------

PVC, PP, PE, PER, ABS un HDPE caurulēm

~~PPR~~

Universāla cauruļu galu frēze VIRAX

221251	69.84	35 mm	2035017
--------	-------	-------	---------

221252	121.55	56 mm	2035046
--------	--------	-------	---------



Kalibrators VIRAX

221276	65.74	16x2-20x2-25x2,5-25x3-32x3 mm	2035018
--------	-------	-------------------------------	---------



Kalibrators VIRAX

221278	67.19	16x2,25-20x2,5-25x2,5-25x3-32x3 mm	2035019
--------	-------	------------------------------------	---------



EUR
VEIKALS

EUR
VEIKALS

221135 **43.8** **2035045**

Caurumgrieznis 35 mm



200210 **196.92** **2035041**

Cauruļveida skrūvspīles Etaugriff
1.1/4" x 3"



250580 **131.35** **2035047**

Profesionāls cauruļu valcētājs
3/16 - 1/4 - 5/16 - 3/8 - 1/2 - 5/8 - 3/4



220425 **71.41** 3/8"-1" **2035016**

Radiatoru atslēga 4 izmēri VIRAX



253502 **1406.73** M21 **2035059**

Elektriskā rokas prese VIRAX



261450 **62.97** **2035049**

Izlietnes teleskopiska atslēga Sanicrom
1,3/8"



253521 **1408.68** ML21 **2035060**

Elektriskā rokas prese VIRAX



261470 **39.15** **2035050**

Krāna uzgriežņa atslēga ar rokturi



990156 **284.64** 15-18-22 **2035081**

252955 **99.97** 28 **2035082**

Ieliktnis rokas preseī, karbonam





Ieliktnis rokas preseī

252904	68.25	TH 16	2535061
252907	68.25	TH 20	2535062
252909	68.55	TH 25	2535063
252915	67.92	U 16	2535064
252917	67.92	U 20	2535065
252918	67.56	U 25	2535066



EUR
VEIKALSEUR
VEIKALS

 <p>2.13</p> <p>Gāzes balons 190g ar STOP funkciju EN417-2012</p>	<p>Gāzes balons 190 gr 2035020</p> <p>7.16</p> <p>Gāzes balons 230gr. Ar 7/16 vītņi-tūristiem un pavāriem</p>  <p>Gāzes balons 230 gr 2035025</p>
 <p>5.65</p> <p>Prop/but mix gāzes balons 600ml EN417</p>	<p>Gāzes balons 600 ml 2035021</p> <p>9.53</p> <p>Gāzes balons 500 gr. ar STOP funkciju EN417-2012</p>  <p>Gāzes balons 500 gr 2035026</p>
 <p>8.13</p> <p>Gāzes balons 450 gr. EN417-2012</p>	<p>Gāzes balons 450 gr 2035022</p> <p>29.51</p> <p>Gāzes maisījums kas nodrošina 3050 grādu temperatūru</p>  <p>Gāzes balons 610 ml 2035027</p>
 <p>4.71</p> <p>Šķiltavu gāze ar 5 adapteriem-400ml/220 gr.</p>	<p>Gāzes balons 400 ml 2035023</p> <p>32.38</p> <p>Gāzes balons ar US vītņi, paredzēts amerikāņu degļiem</p>  <p>Gāzes balons 400 gr 2035028</p>
 <p>4.18</p> <p>Gāzes balons pavāriem un portatīvajiem degļiem,plītīm</p>	<p>Gāzes balons 227 gr 2035024</p> <p>16.47</p> <p>Želejveida gāze - darbam jebkurā leņķī,ar temperatūru līdz 2100 grādiem.</p>  <p>Gāzes balons 400 ml 2035029</p>

INSTRUMENTI

EUR
VEIKALS

AG384

Deglis ar šļauku Providus
paredzēts 190 gr baloniem

41.48

2035030



EUR
VEIKALS

Gāzes deglis ar Piezo aizdedzi, gāzes balonu
PV900 komplekts Nr.1

30.13

vītne 7/16

400 ml

2035034



PG900

Deglis ar pjezo aizdedzi
un gāzes padeves regulātoru
paredzēts 190 gr baloniem

33.52

2035031



GA 200

Deglis
vītne 7/16

89.92

2035035



AV084 komplekts Nr.1

Deglis ar šļūteni
vītne 7/16
ar gāzes balonu
600 ml

41.92

2035032



AD450

Adapteris degļiem Providus

26.68

2035036



Misiņa deglis ar gāzes balonu
PV500 komplekts Nr.1

22.90

vītne 7/16

600 ml

2035033



115050

Portatīvais metināšanas komplekts
Oxyturbo TURBO SET 90

250.80

2035037



EUR
VEIKALSEUR
VEIKALS

<p>WS-36-400 <i>Rūsas pārveidotājs</i></p>  <p>7.46 2072005</p> <p>Izcili piemērots sarūsējušu savienojumu, vītņu darba atjaunošanai, samazina berzi, izspiež mitrumu, atvieglo savienojumu montāžu un demontāžu</p>	<p>WS-81-400 <i>Zinc-Alu-Mix Spray</i></p>  <p>13.83 2072001</p> <p>Paredzēts šuvju maskēšanai un metināšanas darbiem. Noturīgs pret jebkuriem laika apstākļiem, aizsargā pret rūsas, oksidēšanos.</p>
<p>WS-38-400 <i>Rūsas pārveidotājs SPECIAL</i></p>  <p>8.96 2072000</p> <p>Īpašs sastāvs no molibdēna un sintētiskām piedevām - īpaši paredzēts saaugušiem rūsas savienojumiem, kurus nevar atskrūvēt. Ātras iedarbības līdzeklis.</p>	<p>WS-85-400 <i>Zinc Primer Spray-Cinkam</i></p>  <p>15.43 2072012</p> <p>Labs pretrūsas līdzeklis, satur - 99% cinka, labi vada elektrību, var maskēt metināšanas šuves. Ātri žūst</p>
<p>WS-40-400 <i>Daudzfunkciju areosols</i></p>  <p>10.65 2072007</p> <p>Daudzfunkcionāls līdzeklis savienojumu eļļošanai un aizsardzībai pret rūsas, rūsas noņemšanai, detaļu tīrīšanai. Universāls specializēts līdzeklis ar pretrūsas aizsardzību. COBRA uzgalis</p>	<p>WS-167-400 <i>Chain Guard</i></p>  <p>14.10 2072010</p> <p>Ļoti efektīvs pievadķēžu un metāla tauvu aizsarglīdzeklis, smērviela - savienojams ar lielāko daļu eļļu un noturīgs pret mitru, agresīvu vidi. Momentāla iedarbība, pie augstām temperatūrām nenotek. Ļoti ekonomisks - ilgi servisa starposmi.</p>
<p>WS-66-400 <i>Rūsas pārveidotājs Gruntskrāsa</i></p>  <p>15.40 2072009</p> <p>3 in 1. Rūsas pārveidotājs, gruntskrāsa un pildviela. Noturīgs pret āra apstākļiem, jūras ūdeni, karstumu, piemērots, alumīnijam, metālam, cinkotām virsmām, betonam, šiferim.</p>	<p>WS-440-400 <i>Anti-Corrosion Wax Spray</i></p>  <p>15.57 2072008</p> <p>Pretrūsas ilgstošas aizsardzības vasks. Aizsargā no rūsas rašanās - noturīgs pret ūdeni, ceļu kaisāmo sāli, neīrūmēm, utt. Ideāls līdzeklis instrumentu un augstas precizitātes detaļu konservācijai un aizsardzībai.</p>

DUŠAS KABĪNES

VEIKALS



Dušas kabīne pusapaļa, komplektā ar akmens masas paliktņi

80x80x185	FSK21038-80R	435.00	7174017
90x90x185	FSK21038-90R	530.40	7174016

Dušas kabīne, pusapaļa

80x80x185	FSE21038-80R	215.00	7174001
90x90x185	FSE21038-90R	215.00	7174000

Dušas kabīne pusapaļa, komplektā ar akrila paliktņi

90x90x185	FSK21038-90akr	292.40	7174019
-----------	----------------	---------------	----------------



Dušas kabīne kvadrāts ar akmens masas dušas paliktņi

90x90x185	FSK21038-90S	465.00	7174015
-----------	--------------	---------------	----------------

Dušas kabīne, kvadrāts

90x90x185	FSE21038-90S	230.00	7174002
-----------	--------------	---------------	----------------

Dušas durvis FLORY dušas kabīnei, komplekts

90x90x185	kantaina DOOR90S	81.23	7174007
80x80x185	pusaplis DOOR80R	78.84	7174011
90x90x185	pusaplis DOOR90R	86.50	7174009

Dušas sienas FLORY dušas kabīni, komplekts

90x90x185	kantaina SIDE90S	71.46	7174008
80x80x185	pusaplis SIDE80R	53.44	7174012
90x90x185	pusaplis SIDE90R	62.91	7174010

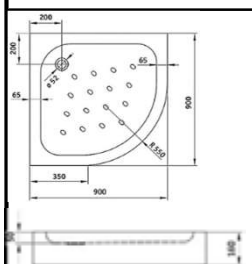

Dušas paliktņis, pusapaļš akrila

90x90R **122.10** **8274053**

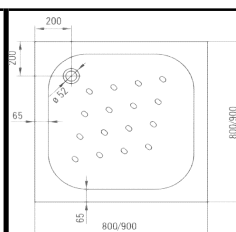

Dušas paliktņis, kvadrāts akrila

90x90R **122.10** **8274058**



Ieteicamais sifons 0205374 vai 0205458

P 706 / P 708

Dušas paliktņis, pusapaļš ar kājām un paneli akmens masas

90x90R **339.27** **7174014**
 80x80R **234.65** **7174018**



Augstums 15 cm
 Biezums 3 cm
 Diametrs 90

Ieteicamais sifons 0205240

P 707

Dušas paliktņis, kvadrāts ar kājām un paneli akmens masas

90x90 **246.45** **7174013**



Augstums 15 cm
 Biezums 3 cm
 Diametrs 90

Ieteicamais sifons 0205240

Ieteicamais sifons 0205374 vai 0205458

Riteņu komplekts duškabīnēm 4 gab



FSE21038 **14.86** **7174006**

Blīvgumija alumīnija profilam (2 gab.)

FSE21038 **5.80** **7174003**

Gumijas profils stiklam (2 gab.)

FSE21038 **5.80** **7174004**

Blīvgumija ar magnētu (2 gab.)

FSE21038 **25.00** **7174005**